

Hardware Manual

Industrial Cellular Router

ICR-2734



© 2025 Advantech Czech s.r.o. No part of this publication may be reproduced or transmitted in any form or by any means, electronic or mechanical, including photography, recording, or any information storage and retrieval system without written consent. Information in this manual is subject to change without notice, and it does not represent a commitment on the part of Advantech.

Advantech Czech s.r.o. shall not be liable for incidental or consequential damages resulting from the furnishing, performance, or use of this manual.

All brand names used in this manual are the registered trademarks of their respective owners. The use of trademarks or other designations in this publication is for reference purposes only and does not constitute an endorsement by the trademark holder.

Used symbols



Danger – Information regarding user safety or potential damage to the router.



Attention – Problems that can arise in specific situations.



Information – Useful tips or information of special interest.



Contents

1. Product Overview	1
1.1 Document Content	1
1.2 Product Introduction	2
1.3 Hardware Overview	3
1.4 Order Codes	5
1.5 Product Revisions	6
1.6 Package Contents and Accessories	7
1.7 Product Dimensions	9
1.8 Mounting Recommendations	11
1.9 DIN Rail Mounting	12
1.10 Product Label	13
1.11 First Use	14
2. Hardware Functionality	15
2.1 SIM Card Slots	15
2.2 Antennas	16
2.3 Ethernet Interfaces	16
2.4 Power Supply	17
2.5 Low Power Mode	18
2.6 USB Port	18
2.7 LED Status Indication	19
2.8 Reset Functions	20
3. Technical Specifications	21
3.1 Basic Parameters	21
3.2 Standards and Regulations	22
3.3 Type Tests and Environmental Conditions	23
3.4 Parameters of Cellular Module	24
3.5 Parameters of WiFi	25
3.6 System Configuration	26
Appendix A: Troubleshooting	27
Appendix B: Customer Support	30
Appendix C: Regulatory & Safety Information	31
Appendix D: Related Documents	32

List of Figures

1	Hardware Overview of the Router	3
2	Metal Box – Top, Side and Front View	9
3	Plastic Box – Top, Side and Front View	10
4	Position of the DIN Rail Clip	12
5	Removing Router from the DIN Rail	12
6	Product Label	13
7	SIM Cards Insertion	15
8	Ethernet Connector Pinout	16
9	Connection of Power Supply	17
10	Position of the Grounding Screw	17
11	USB Connector Pinout	18
12	Resetting the Router	20

List of Tables

1	Hardware Overview of the Router	4
2	Order Codes Overview	5
3	HW Revisions History	6
4	Contents of Package	8
5	Ethernet Connector Pinout Description	16
6	Power Supply Pinout	17
7	USB Connector Pinout	18
8	LED Status Indication	19
9	Basic Parameters	21
10	Standards and Regulations	22
11	Type Tests and Environmental Conditions	23
12	Technical Parameters of Cellular Module	24
13	Technical Parameters of WiFi	25
14	System Configuration	26

1. Product Overview

1.1 Document Content

This manual provides detailed information for Advantech ICR-2734 routers, offering comprehensive guidance on the following topics:

- **Product Overview** – Product-related information such as order codes, product revisions, package contents, product dimensions, and mounting instructions.
- **Hardware Functionality** – Description of all hardware components, including SIM slots, antennas, Ethernet ports, power options, LED status indicators, reset functions, and others.
- **First Use** – Instructions for the initial setup and usage of the router.
- **Technical Specifications** – Basic parameters, standards and regulations, type tests, module specifications, and interface parameters.

1.2 Product Introduction

Industrial cellular router ICR-2734 is designed for wireless communication in mobile networks that use traditional cellular technologies.

The primary purpose of this router is its use in the Category 4 (**Cat.4**) services on the cellular **LTE** network. Cat.4 rated router is capable of achieving typical speeds in 4G coverage areas where the network is enabled with 20 MHz of contiguous spectrum.

The peak **downlink** data rate for Category 4 is approximately **150 Mbps**. In the **uplink**, LTE Category 4 provides a peak data rate of **50 Mbps**.

The router, which may have a **metal** or **plastic** box, is equipped with two independently configurable **Ethernet ports**, two **Mini SIM slots** (2FF), main and diversity cellular **antenna connectors**, with one **USB 2.0** host interface and with **LEDs for status** indication. The router can be equipped with a **dual-band WiFi module**, but this must be part of the initial configuration – it cannot be assembled to the router at some point in the future.

The router provides **diagnostic functions**, which include automatically monitoring the PPP connection, automatic restart in case of connection losses, **Low Power Mode** and **hardware watchdog** that monitors the router status.

The router supports **VPN tunnel** creation using various protocols to ensure safe communications. The router provides diagnostic functions which include automatic monitoring of the wireless and wired connections, automatic restart in case of connection losses, and a hardware watchdog that monitors the router status.

With open Linux platform and wide possibilities of programming customer SW applications in **Python**, **C/C++**. The Advantech existing app library **Router Apps** (formerly *User modules*) with apps already developed to enhance specific router functionality including industrial protocol conversions and support of IoT platforms such as **MS Azure**, **Cumulocity**, **ThingWorx**, and others are supported on the router.

The router supports automatic upgrades of both its configuration and firmware, leveraging updates from a central server. This feature ensures that the router remains up-to-date with the latest enhancements and security protocols.

This model is compatible with Advantech's remote device management platforms: [WebAccess/DMP](#) and [WebAccess/VPN](#). These platforms facilitate comprehensive management and monitoring of network devices.

Examples of possible applications

- mobile office
- fleet management
- security system
- telematic
- telemetric
- remote monitoring
- vending and dispatcher machines

1.3 Hardware Overview

The router case preview is shown in Figure 1. A short description of hardware parts of the router is listed in Table 1, including the links to the chapters with a detailed description. For a router in a plastic box, the description of the components is similar.



Figure 1: Hardware Overview of the Router

#	Item/Caption	Type	Description
1	LEDs	-	Status LED indication; see Chapter 2.7.
2	SIM slots	Mini SIM	Two SIM card slots; see Chapter 2.1.
3	ANT	SMA	Connector for the first main antenna of the cellular module; see Chapter 2.2 and Chapter 3.4 for cellular module parameters.
4	DIV	SMA	Connector for the first diversity antenna of the cellular module; see Chapter 2.2 and Chapter 3.4 for cellular module parameters.
5	USB	USB-A	USB-A type socket connector; see Chapter 2.6.
6	ETH0, ETH1	RJ45	100 MB Ethernet connection for the first and second LAN; see Chapter 2.3.
7	PWR	2-pin terminal	Power supply socket; see Chapter 2.4.

Continued on the next page

Continued from previous page

#	Item/Caption	Type	Description
8	RST	-	Button to reboot the router or to restore the default configuration; see Chapter 2.8.
9	WiFi	RP-SMA female	WiFi antenna connector; see Chapter 2.2 for more information and Chapter 3.5 for WiFi parameters.
10	DIN clip	-	DIN rail clip, included as standard accessories; see Chapter 1.9.
11	Grounding screw	M3	Pay attention to proper grounding of model with metal box; see Chapter 2.4.

Table 1: Hardware Overview of the Router

1.4 Order Codes

Order codes overview is shown in the table below.

Order code	Configuration
ICR-2734	metal box, LTE Cat.4 with 3G/2G fallback module, ETH0, ETH1, USB, two SIM readers
ICR-2734P	plastic box , LTE Cat.4 with 3G/2G fallback module, ETH0, ETH1, USB, two SIM readers
ICR-2734A01	metal box, LTE Cat.4 with 3G/2G fallback module, ETH0, ETH1, USB, two SIM readers, accessories with Ethernet cable, two cellular antennas, and EU power supply
ICR-2734PA01	plastic box , LTE Cat.4 with 3G/2G fallback module, ETH0, ETH1, USB, two SIM readers, accessories with Ethernet cable, two cellular antennas, and EU power supply
ICR-2734A02	metal box, LTE Cat.4 with 3G/2G fallback module, ETH0, ETH1, USB, two SIM readers, accessories with Ethernet cable, two cellular antennas, and UK power supply
ICR-2734PA02	plastic box , LTE Cat.4 with 3G/2G fallback module, ETH0, ETH1, USB, two SIM readers, accessories with Ethernet cable, two cellular antennas, and UK power supply
ICR-2734W	metal box, LTE Cat.4 with 3G/2G fallback module, ETH0, ETH1, USB, two SIM readers, dual-band WiFi
ICR-2734WP	plastic box , LTE Cat.4 with 3G/2G fallback module, ETH0, ETH1, USB, two SIM readers, dual-band WiFi
ICR-2734WA01	metal box, LTE Cat.4 with 3G/2G fallback module, ETH0, ETH1, USB, two SIM readers, dual-band WiFi , accessories with Ethernet cable, two cellular with one WiFi antennas, and EU power supply
ICR-2734WPA01	plastic box , LTE Cat.4 with 3G/2G fallback module, ETH0, ETH1, USB, two SIM readers, dual-band WiFi , accessories with Ethernet cable, two cellular with one WiFi antennas, and EU power supply
ICR-2734WA02	metal box, LTE Cat.4 with 3G/2G fallback module, ETH0, ETH1, USB, two SIM readers, dual-band WiFi , accessories with Ethernet cable, two cellular with one WiFi antennas, and UK power supply
ICR-2734WPA02	plastic box , LTE Cat.4 with 3G/2G fallback module, ETH0, ETH1, USB, two SIM readers, dual-band WiFi , accessories with Ethernet cable, two cellular with one WiFi antennas, and UK power supply
ICR-.....-S1..	The -S1 prefix indicates that the product is designed for the S1 Products platform. This platform ensures compliance with strict security requirements. For more details, refer to the S1 version of the configuration manual [1].

Table 2: Order Codes Overview

1.5 Product Revisions

For the product revision history of the entire product platform, refer to the table below. Please note that some revisions may not be available for certain order codes. The revision number is printed on both the packaging and product labels.

The router GUI can also display the product revision under *Status* → *General* → *System Information* → *Product Revision*. Please note that the default revision (Rev. 1.0) may not be available here.

Rev.#	Description
1.0	Initial version (revision number not printed on the labels).
2.0	WiFi support added to the mainboard; see PCN-2023-10 for details.
2.1	Changed color of the DAT LED; see PCN-2023-11 for details.

Table 3: HW Revisions History

1.6 Package Contents and Accessories

Table 4 refers to router package contents and other accessories, which depend on the order code; see Chapter 1.4. You can order an accessory separately; use the order code mentioned.

Description	Figure	Q'ty
Router in metal or plastic box		1 pc
DIN rail clip with screws (screws differ for metal and plastic versions)		1 set
2-pin terminal block for power supply (deployed on the router)		1 pc
Printed <i>Quick Start Guide Leaflet</i>		1 pc
Ethernet cross cable of length 1.5 m. Order code: <i>BB-KD-ETH</i>		0 / 1 pc
5G/LTE Antenna (SMA male). Order code: <i>ANT-LTE5G-025</i>		0 / 2 pcs
WiFi Antenna (RP-SMA male). Order code: <i>BB-AW-A2458G-FSRPK</i>		0 / 1 pc

Continued on the next page

Continued from previous page



Description	Figure	Q'ty
Wall mount power supply, 12V/1A with EU plug. Order code: <i>BB-RPS-v2-EU</i>		0 / 1 pc
Wall mount power supply, 12V/1A with UK plug. Order code: <i>BB-RPS-v2-UK</i>		0 / 1 pc
Wall mount power supply, 12V/1A with US plug. Order code: <i>BB-RPS-v2-US</i>		0 / 1 pc

Table 4: Contents of Package

1.7 Product Dimensions

For the dimensions of the product in metal and plastic boxes see the figures below. Note that all sizes are measured in millimeters.

Variant with Metal Box

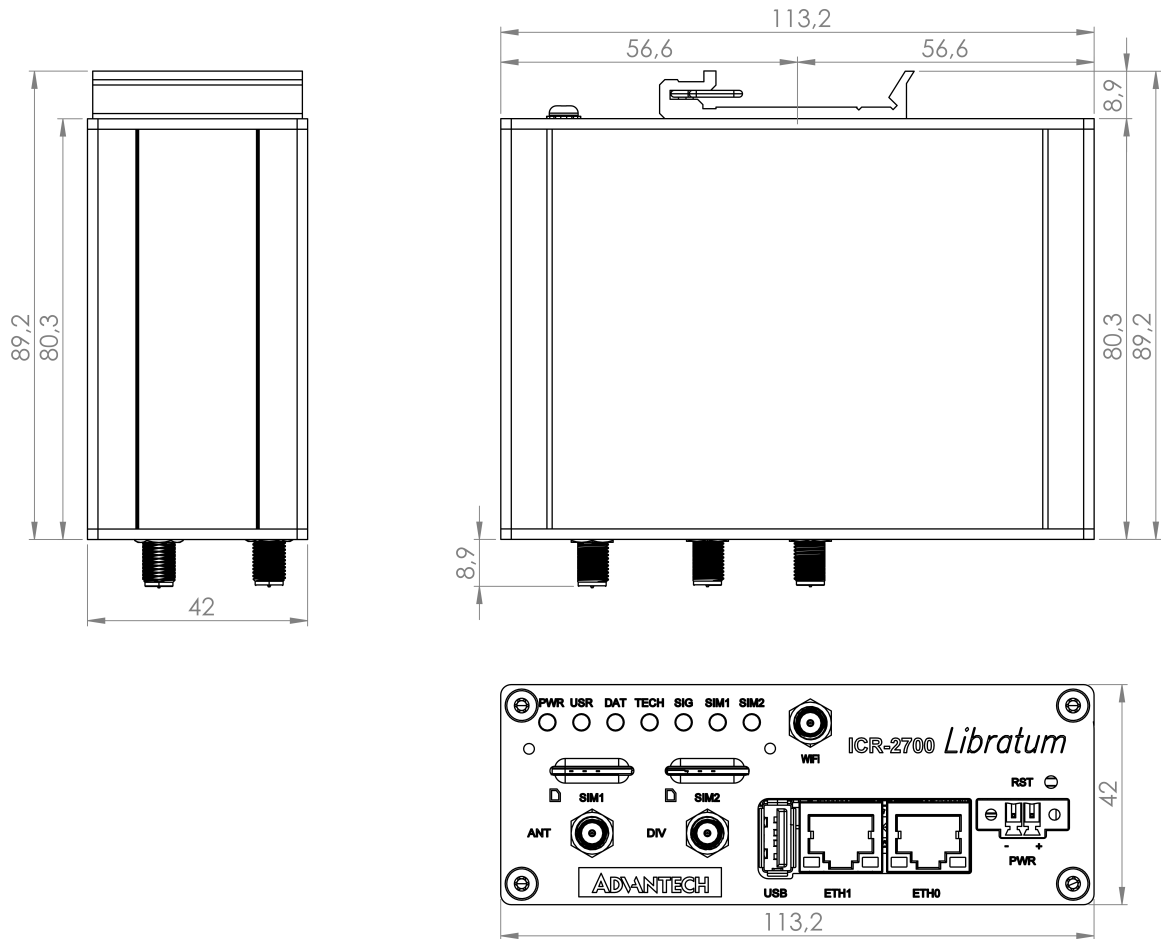

Figure 2: Metal Box – Top, Side and Front View

Variant with Plastic Box

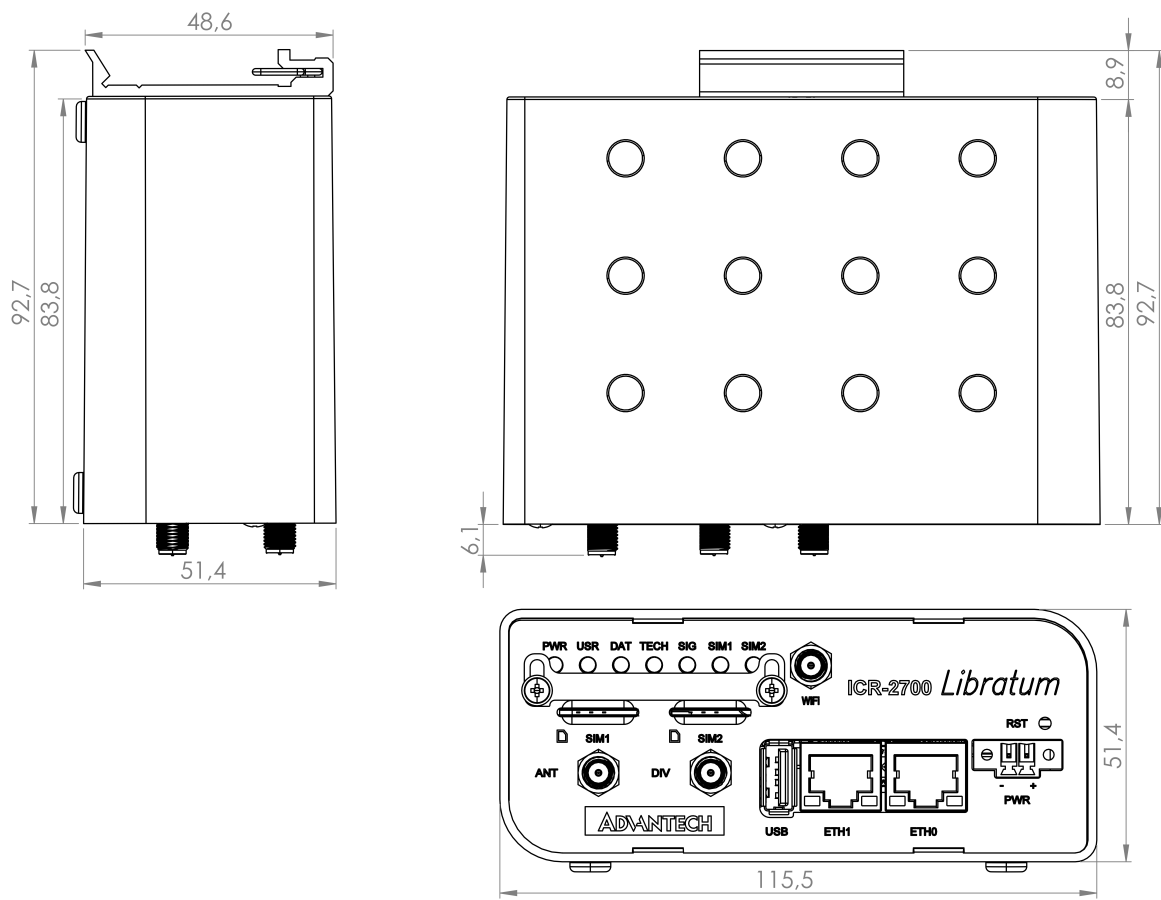

Figure 3: Plastic Box – Top, Side and Front View

1.8 Mounting Recommendations

The router can be placed:

- on a flat surface,
- on a DIN rail EN 60715 with the metal DIN rail clip (see Chapter 1.9)

For most applications with a built-in router within a switchboard, it is possible to recognize two kinds of environments:

- A non-public, industry environment of low voltage with high interference,
- a public environment of low voltage and without high interference.

For both of these environments, it is possible to mount the router to a switchboard, after which there is no need to have examination immunity or issues in connection with EMC according to EN 61439-1:2011.



In compliance with the EN 61439-1:2011 specification, it is necessary to observe the following assembly instructions for a router attached to a switchboard:

- For whip antennas it is recommended to observe a minimum distance of 6 cm from cables and metal surfaces on every side in order to avoid interference. When using an external antenna separate from the switchboard it is necessary to fit a lightning conductor.
- When mounting a router on sheet-steel we recommend using a cable antenna.
- For all cables, we recommend to bind the bunch, and for this we recommend:
 - The length of the bunch (the combination of power supply and data cables) should be a maximum 1.5 m. If the length of data cables exceeds 1.5 m or if the cable is leading towards the switchboard, we recommend installing surge protectors.
 - Data cables must not have a reticular tension of ~ 230 V/50 Hz or ~ 120 V/60 Hz.
- Sufficient space must be left between each connector for the handling of cables,
- To ensure the correct functioning of the router we recommend the use of an earth-bonding distribution frame for the grounding of the grounding screw, see Chapter 2.4.

1.9 DIN Rail Mounting

The DIN rail clip is suitable for a DIN rail according to EN 60715 standard only. There are four possible positions of the clip as shown in Figure 4.

i The DIN rail clip is the same for the metal and plastic router box. It just differs by the screws used.

! When mounting the DIN rail clip, tighten the screws with max. torque of 0.4 Nm.

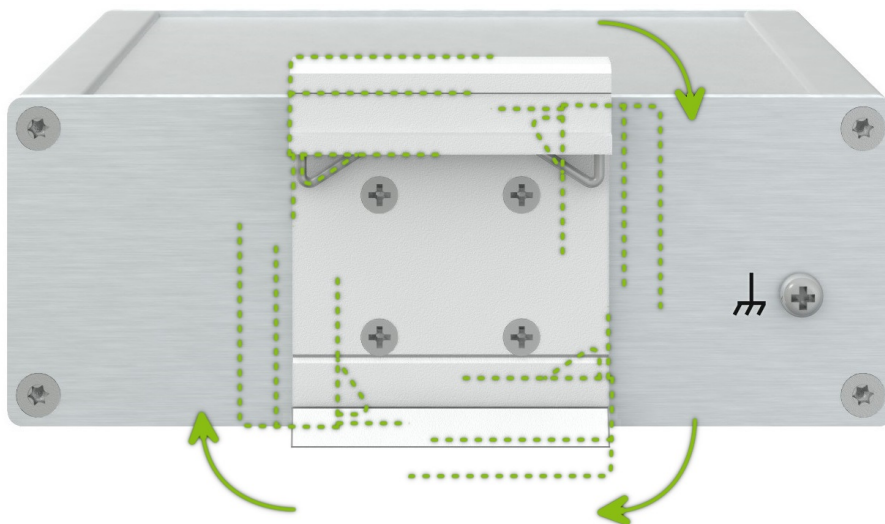

Figure 4: Position of the DIN Rail Clip

To remove the router from the DIN rail it is necessary to lightly push down the router so that the bottom part of the DIN rail clip hitched to the DIN rail get out of this rail and then fold out the bottom part of the router away from the DIN rail, see Figure 5.

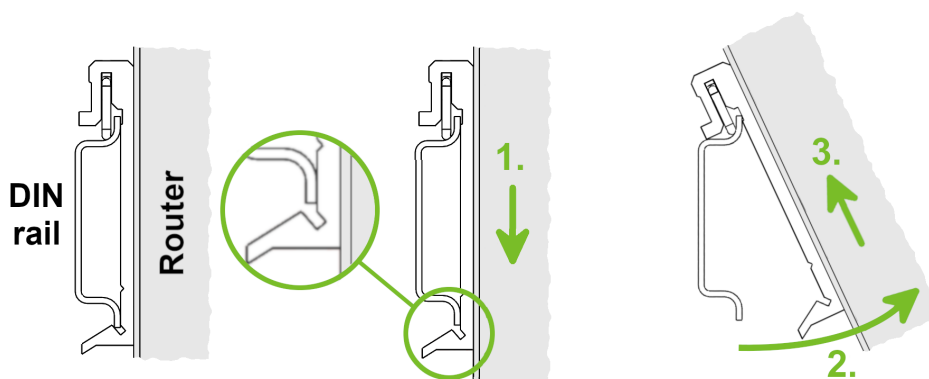

Figure 5: Removing Router from the DIN Rail

1.10 Product Label

The figure below shows an example of the product labels with all the information printed on them.

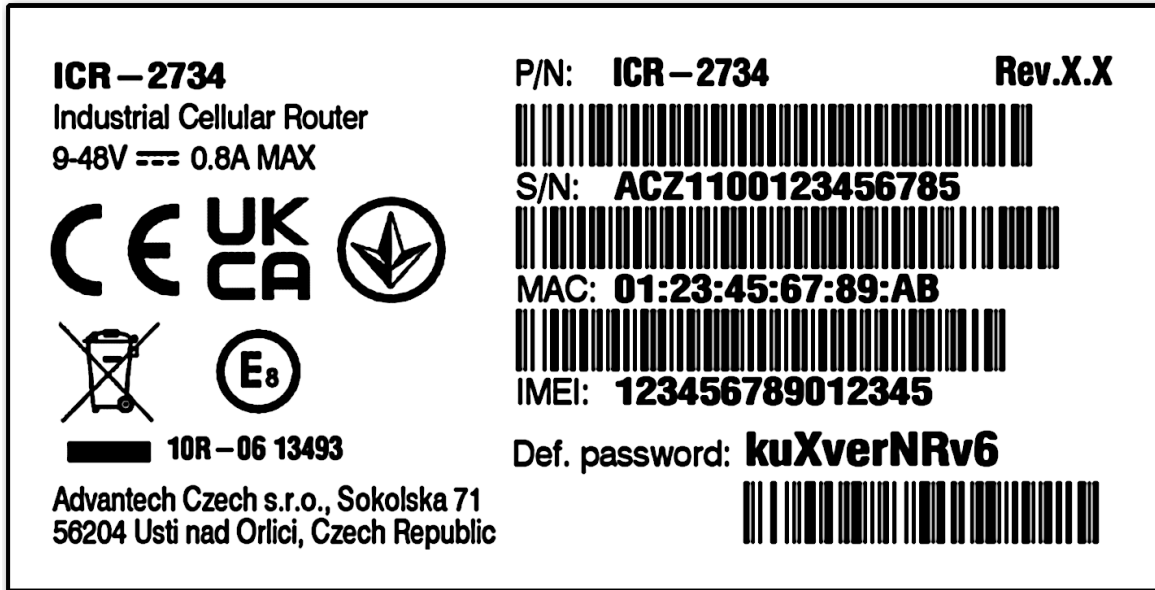



Figure 6: Product Label

1.11 First Use

You can perform the initial configuration of the router using a web browser on your PC. This interface enables router monitoring, configuration, and administration.

- 
- Before putting the router into operation, ensure that all components required for running your applications are connected. Refer to Chapter [1.3 Hardware Overview](#) for an overview of the hardware.
 - Do not operate the router without an antenna connected to the main antenna connector. Transmitted energy will be reflected by an open connector, which could potentially damage the equipment.

The procedure for connecting to a new router is described in the *Configuration Manual* [1], Chapter *Introduction* → *Configuration Environments* → *Initial Web Configuration GUI Access*. This manual also provides detailed descriptions and examples of router configuration using the web interface.

2. Hardware Functionality

See Chapter 1.3 for an overview of the product's hardware, along with links to chapters offering detailed explanations.

2.1 SIM Card Slots

Slots for two SIM cards are located on the router beneath a metal cover. If you plan to use this device for cellular network communication, insert an activated data-provisioned SIM card into the SIM card slot.

You have the option to install two SIM cards simultaneously for utilizing the switching feature. The SIM cards can have different Access Point Names (APNs) configured. The procedure for changing SIM cards is outlined below. If the SIM requires a PIN, input it in the router's web interface (*Administration* → *Unlock SIM Card*).

i Type of SIM card: Mini SIM (2FF) 25.0 × 15.0 × 0.76 mm.

Inserting the SIM card:

- Always disconnect the router from the power supply before handling the SIM card.
- Release the two screws on the SIM card cover and swipe up the cover.
- To remove an inserted SIM card, use the flat end of a spudger or your fingernail to press the SIM card slightly into its slot until you hear a click. Upon hearing the click, release the card, and it will pop out of its slot.
- To insert a SIM card, push the card into the slot until it clicks into place.
- Swipe down the cover and tighten the cover screws.

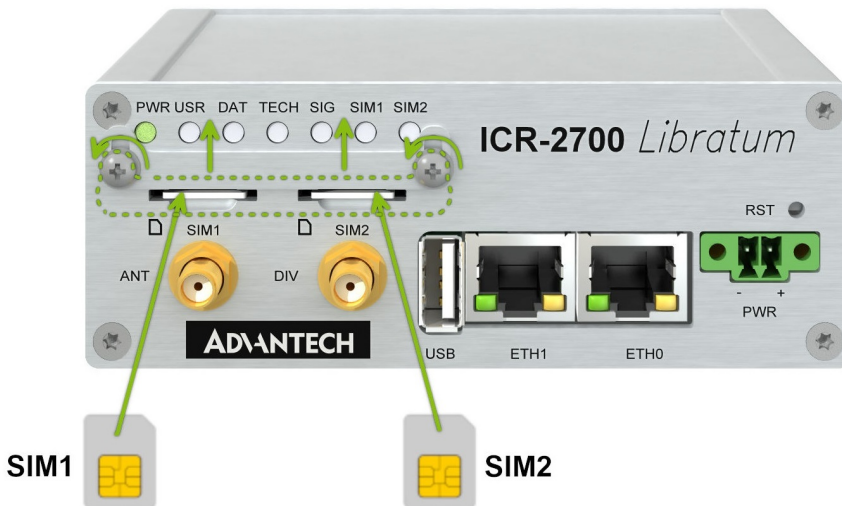

Figure 7: SIM Cards Insertion

2.2 Antennas

Connect cellular antennas to the router to main (ANT) and diversity (DIV) SMA female connectors on the front panel. If the router is WiFi equipped, connect the WiFi antenna to the WiFi RP-SMA female connector on the front panel.



Only run the router with a cellular antenna connected to the main antenna connector, as the energy from the transmission is effectively reflected by the open end and can damage the equipment.



The DIV cellular antenna is required for the MIMO DL functionality.



Recommended tightening moment for screwing the antenna to the SMA female connectors is 0.9 Nm.

2.3 Ethernet Interfaces

The panel socket of RJ45 is used for Ethernet interface. The pinout of the socket is shown in Figure 8 and described in Table 5.

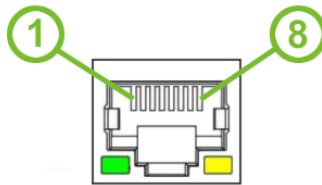

Figure 8: Ethernet Connector Pinout

Pin	Signal mark	Description
1	Tx+	Transmit Data+ (positive pole)
2	Tx-	Transmit Data- (negative pole)
3	Rx+	Receive Data+ (positive pole)
4	—	—
5	—	—
6	Rx-	Receive Data- (negative pole)
7	—	—
8	—	—

Table 5: Ethernet Connector Pinout Description



The isolation barrier of the Ethernet ports against the ground is 1500 V.

2.4 Power Supply

A two-pin terminal connector (pitch 3.5 mm) is utilized to power the router. The corresponding connector is included as a standard accessory with the router.

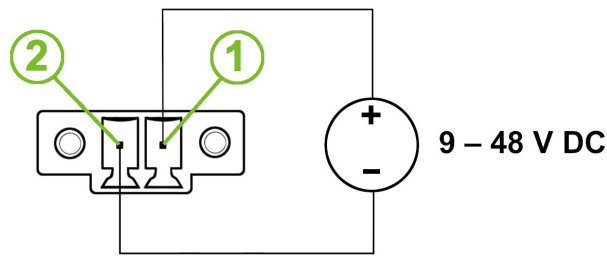

Figure 9: Connection of Power Supply

Pin	Signal mark	Description
1	PWR(+)	Positive pole of DC supply voltage (+9 to +48 V DC)
2	PWR(-)	Negative pole of DC supply voltage

Table 6: Power Supply Pinout

The required power supply voltage for the router ranges between +9 V and +48 V DC. Refer to the connection scheme in Figure 9 for proper setup. The router is equipped with built-in protection against reversed polarity, functioning without signaling. To guarantee correct operation, the power source must be capable of providing a sufficient amount of energy, as detailed in the consumption section of Chapter 3.1.



Unit has to be supplied by a power supply specified as a Limited Power Source (LPS) or CEC/NEC Class 2 source of supply.

All metal parts, including the box, are interconnected with the negative pole of the power supply (common pole). If recommended for the installation environment, protect the router by properly grounding it using the grounding screw, as depicted in Figure 10. The maximum tightening torque for the grounding screw is 1 Nm.

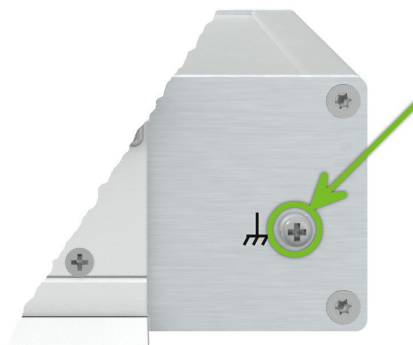

Figure 10: Position of the Grounding Screw

2.5 Low Power Mode



In applications requiring low power consumption (such as solar power - not 7/24 mode) is strictly recommended to use LPM mode prior to powering down the entire router.

LPM (Low Power Mode) is a router mode where the router is in sleep mode with minimal power consumption; see Chapter 3.1 for the LPM consumption. The router can be woken up from this mode after a predetermined period of time. Putting the router into LPM mode can be done using the `lpm` command, see [Command Line Interface](#) application note for more details.

2.6 USB Port

The router is equipped with a single USB 2.0 host port featuring a USB-A type socket. The pinout details of the USB socket are illustrated in Figure 11 and further described in Table 7.

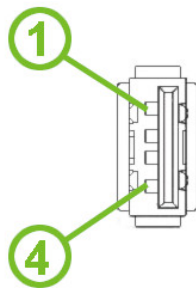

Figure 11: USB Connector Pinout

Pin	Signal Mark	Description	Data Flow Direction
1	+5 V	Positive pole of 5 V DC supply voltage, 0.5 A	
2	USB Data -	USB data signal (negative pole)	Input/Output
3	USB Data +	USB data signal (positive pole)	Input/Output
4	GND	Negative pole of DC supply voltage	

Table 7: USB Connector Pinout

For detailed USB port configuration options, refer to the configuration manual [1], Chapter *Configuration* → *USB Port*.

2.7 LED Status Indication

There are LED indicators on the front panel of the router to provide router status information. Moreover, ETH connector, has two additional LEDs providing information about the port status.

Caption	Color	State	Description
PWR	Green	On	The router is booting up.
	Green	Blinking	The router booted up and is ready.
	Green	Fast blinking	The router firmware is being updated.
USR	Green	—	The function of this LED is user-defined.
DAT	Red	Blinking	Cellular communication is in progress.
TECH	Green	On	The active SIM uses 4G technology.
	Orange	Blinking	The active SIM uses 3G technology.
	Red	Fast blinking	The active SIM uses 2G technology.
SIG	Green	On	Good cellular signal.
	Orange	Blinking	Fair cellular signal.
	Red	Fast blinking	Poor cellular signal.
SIM1	Green	On	SIM1 is active for the cellular connection.
	Red	Fast blinking	A SIM1 issue (missing card or PIN not entered).
SIM2	Green	On	SIM2 is active for the cellular connection.
	Red	Fast blinking	A SIM1 issue (missing card or PIN not entered).
ETH0	Green	On	Selected 100 Mbps bit rate.
ETH1	Green	Off	Selected 10 Mbps bit rate.
ETH0 ETH1	Orange	On	The network cable is connected.
	Orange	Brief off blinks	Data transmission.
	Orange	Off	The network cable is not connected.

Table 8: LED Status Indication

2.8 Reset Functions

The *RST* button has multiple functions. For more details, refer to the configuration manual [1], Chapter *Introduction* → *Device* → *Reset*.

-  Use a narrow screwdriver or a small tool to press the *RST* button.



Figure 12: Resetting the Router

3. Technical Specifications

3.1 Basic Parameters

Parameter		Description
Temperature range	Operating Storage	-40 °C to +75 °C -40 °C to +85 °C
Humidity	Operating Storage	5 to 95 % relative humidity non condensing 5 to 95 % relative humidity non condensing
Altitude	Operating	2000 m / 70 kPa
Degree of protection		IP30
Supply voltage		9 to 48 V DC
Battery for RTC		CR1225
Consumption for non-WiFi (WiFi) version	Idle Average Maximum LPM mode	1.6 W (2.3 W) 3.0 W (4.0 W) 6.9 W (7.7 W) 3 mW
Dimensions of device w/o clip		113,2 × 80,3 × 42 mm (metal box) 117 × 83,8 × 51,4 mm (plastic box)
DIN rail clip specification		DIN 35 mm, EN 60715
Weight		260 g (metal box) 200 g (plastic box)

Table 9: Basic Parameters

3.2 Standards and Regulations

The router complies with the following standards and regulations:

Parameter	Description
Radio	EN 301 511, EN 301 908-1, EN 301 908-2, EN 301 908-13, EN 301 893, EN 300 328
EMC	EN 301 489-1, EN 301 489-17, EN 301 489-52, EN 61000-4-2, EN 61000-4-3, EN 61000-4-4, EN 61000-4-5, EN 61000-4-6, EN 61000-4-11, EN 61000-6-2, EN 61000-6-3, EN 55032
Safety	IEC 62368-1, EN IEC 62311, IEEE 802.3
Transportation	E-Mark (E8), homologation number: 10R-06 13493
National	CE, UKCA, UK compliant
Environmental	REACH, RoHS3 and WEEE compliant

Table 10: Standards and Regulations

3.3 Type Tests and Environmental Conditions

Phenomena	Test	Description	Test levels
ESD	EN 61000-4-2	Enclosure	CD ± 6 kV, L3 AD ± 8 kV, L3
RF field AM modulated	EN 61000-4-3	Enclosure	20 V/m, 80 MHz – 1 GHz, LX 10 V/m, 1 GHz – 6 GHz, L3
Fast transient	EN 61000-4-4	DC ETH - FTP AC/DC	± 1 kV, 5/50Tr/Th ns, 100 kHz, L2 ± 1 kV, 5/50Tr/Th ns, 100 kHz, L3 ± 2 kV, 5/50Tr/Th ns, 100 kHz, L3
Surge	EN 61000-4-5	DC ETH AC/DC	± 1 kV, 1,2/50(8/20) Tr/Th us L2 ± 1 kV, 1,2/50(8/20) Tr/Th us L2 ± 2 kV, 1,2/50(8/20) Tr/Th us L3
RF conducted	EN 61000-4-6	DC ETH AC/DC	10V,0.15-80MHz,80% AM(1kHz),L3 10V,0.15-80MHz,80% AM(1kHz),L3 10V,0.15-80MHz,80% AM(1kHz),L3
Dips & interruptions	EN 61000-4-11	AC/DC	dip 0% 0,5cycle, 0% 1 cycle, 70% 25 cycles, interruption 0% 250 cycles
Radiated emission	EN 55032	Enclosure DC ETH AC/DC	Cl. B,30MHz-1GHz,1GHz-6GHz Class B, 150 kHz – 30 MHz Class B, 150 kHz – 30 MHz Class B, 150 kHz – 30 MHz

Table 11: Type Tests and Environmental Conditions

3.4 Parameters of Cellular Module

Parameter	Description
Antenna	Connector type: SMA Impedance: 50 Ω
LTE parameters	LTE: LTE Cat.4, 3GPP Rel. 10 FDD frequencies: B28 (700 MHz), B20 (800 MHz), B5 (850 MHz), B8 (900 MHz), B3 (1800 MHz), B1 (2100 MHz), B7 (2600 MHz) Bit rates: up to 150 Mbps (DL), 50 Mbps (UL)
HSPA+/UMTS parameters	HSPA: 3GPP Release 7 UMTS: 3GPP Release 4 Supported frequencies: B8 (900 MHz), B3 (1800 MHz), B1 (2100 MHz) Bit rates: max. 21 Mbps (DL) / 5.7 Mbps (UL)
EDGE/GPRS parameters	Supported frequencies: B5 (850 MHz), B8 (900 MHz), B3 (1800 MHz), B2 (1900 MHz) Bit rates: max. 237 kbps (DL) / 237 kbps (UL)

Table 12: Technical Parameters of Cellular Module

3.5 Parameters of WiFi

Parameter	Description
Supported Standards	IEEE802.11 ac/a/b/g/n 2.4 GHz / 5 GHz
Antenna Connector	1x RP-SMA Input impedance: 50 Ω
Data Rate	802.11b: 1, 2, 5.5, 11Mbps 802.11a/g: 6, 9, 12, 18, 24, 36, 48, 54 Mbps 802.11n: Max. 72 Mbps @ 20 MHz channel 802.11n: Max. 150 Mbps @ 40 MHz channel
Frequency Ranges	2.4 GHz ISM Bands 2.412-2.472 GHz 5.15-5.25 GHz (FCC UNII-low band) for US/Canada and EU 5.25-5.35 GHz (FCC UNII-middle band) for US/Canada and EU 5.47-5.725 GHz for EU 5.725-5.825 GHz (FCC UNII-high band) for US/Canada
Modulation	DSSS, OFDM, DBPSK, DQPSK, CCK, 16-QAM, 64-QAM
2.4 GHz Channels	1, 2, 3, 4, 5, 6, 7, 8, 9, 10, 11, 12, 13
5 GHz Channels	36, 38, 40, 42, 44, 46, 48, 52, 56, 60, 64, 100, 104, 108, 112, 116, 120, 124, 128, 132, 136, 140, 149, 153, 157, 161, 165
Type of Device	Access point (AP) (up to 8 clients) Station (STA) Multirole (STA&AP)
Security – Standards	WPA, WPA2, WPA3, 802.1X
Security – Encryption	WEP, TKIP, AES
TX Power	Max. 18 dBm @ 2.4 GHz Max. 15 dBm @ 5 GHz

Table 13: Technical Parameters of WiFi

3.6 System Configuration

The main parameters of the system are listed in Table 14.

Parameter	Description
CPU architecture	ARM926EJ-S
CPU frequency	600 MHz
CPU power	4,72 DMIPS/MHz
Flash memory	4 MB of NOR 4 096 MB of eMMC <ul style="list-style-type: none">• 838 MB for Router Apps• 512 MB for customer data• The remaining space is reserved for the system.
RAM size	128 MB
Watchdog	HW Watchdog
RTC	Battery Backup RTC
TPM ¹	Trusted Platform Module (TPM) 2.0

Table 14: System Configuration

¹Not assembled by default, for a dedicated customer order only.

Appendix A: Troubleshooting

If you cannot connect to the router from your PC, your network card may be configured in such a way that it is not possible to connect to the router. Take one or more of the following steps in order to solve the problem:

- Make sure your PC's network card is configured to obtain the IP address from the DHCP server (by default the DHCP server is running in the router).
- Connect the router to the PC via Switch.
- Connect the router to the PC, start the router first and then start the PC after the router's initialization.

Ethernet connection fails or is not establishing.

- It is possible to turn auto negotiation off and set a rate and duplex manually on the Ethernet interface of the router. Available on "LAN Configuration" page in the router.

Mobile WAN connection fails.

- Check the signal power ("Mobile WAN status" page). If the signal power is weak, you will have to use a better antenna. If the neighbouring cells have a similar signal strength, you will need to use a directional antenna. For proper operation, the signal levels have to be good.
- Try to enable automatic ping from the router, which will check the connection when there are no data running and in the case of a failed ping, restart the connection. This can be done on the "Mobile WAN Configuration" page in the router in the "Check connection" section. "Enable + bind" option is to ensure the ping goes always through Mobile WAN network interface.

Mobile WAN connection cannot be established.

- Check the "Mobile WAN Configuration" – APN, name, password and IP address (all can be blank).
- Try to enter the SIM card PIN – verify that the SIM card has the PIN code entered. Available on "Unlock SIM Card" page in the "Administration" section.
- In a private APN it is not recommended to get the DNS settings from operator (on "Mobile WAN" page)
- Go to "System Log" page in "Status" section and observe where the error occurs.

I cannot connect from the Internet to the device behind the router. I have NAT enabled.

- The device's gateway has to be configured so it points to the router.

I can't access my Web server placed behind the router over NAT.

- The remote HTTP access to the router has to be disabled on "NAT Configuration" page in the router. Also enable "Send all remaining incoming packets to default server" feature and fill in the IP address of your Web server. On the Web server, the default gateway has to be the IP address of the router.

DynDNS doesn't work.

- With private APN this will not work.

- If the same IP address is recorded in your canonic name as a dynamically assigned address, it means that the operator is using NAT or a firewall.
- You can verify NAT using ping to your server with static address and then compare with router's IP address.
- You can verify a Firewall by accessing remotely to the router's Web interface.
- The operator may not provide the address of DNS server and without DNS server's address it is impossible to connect to the dyndns.org server. The following messages will be shown in the System Log:
 - DynDNS daemon started
 - Error resolving hostname: no such file or directory
 - Connect to DynDNS server failed

 **L2TP or IPSec isn't establishing.**

- Check the "System Log" page for error messages.

 **IPSec tunnel establishes but the communication does not run.**

- Probably there are bad routing rules defined in the connected devices, or the default gateway.

 **I switched the router to offline mode by SMS message, but the router is in online mode after reboot.**

- SMS messages do not change the router configuration. They remain in effect only until the router is rebooted.

Is the router Cisco compatible? Can I use the Cisco configuration?

- No, the Firmware in the router (ICR-OS) is based on Linux with BusyBox. Thus the Cisco configuration cannot be used. But network connections are defined by standards so connecting the router to the Cisco or other networking devices is possible and will be compatible.

FTP or SFTP does not work

- FTP will work on v2 routers only. You can use SFTP on all routers to transfer files to/from the router. If having troubles with FTP on v2 routers, make sure you have FTP enabled: "Configuration" section, "Services", "FTP". Then you can connect with any client on port 21 with name and password same as for the Web interface. If having troubles with SFTP, make sure you have SSH enabled: "Configuration" section, "Services", "SSH". Then you can connect with any client on port 22 with name and password same as for the Web interface.

How can I connect to the router's command line? (SSH, Telnet)

- You can use SSH on all routers or Telnet on v2 routers only. SSH is enabled by default, but you can verify in Web interface in "Configuration" section, "Services", "SSH". Then connect with any SSH client on port 22 of the router. User and password is the same as for the Web interface. Telnet on v2 routers can be enabled here: "Configuration" section, "Services", "Telnet".

Appendix B: Customer Support

Customer Support for Europe

Advantech Czech s.r.o.

Sokolska 71
562 04, Usti nad Orlici
Czech Republic

Phone: +353 91 792444
Fax: +353 91 792445
E-mail: iiotcustomerservice@advantech.eu
Web: www.advantech.com

Customer Support for NAM

Advantech B+B SmartWorx

707 Dayton Road
Ottawa, IL 61350 USA

Phone: +1-800-346-3119 (Monday – Friday, 7 a.m. to 5:30 p.m. CST)
Fax: +1-815-433-5109
E-mail: support.iiot.ana@advantech.com
Web: www.advantech.com

Customer Support for Asia

Phone: +886-2-2792-7818 #1299 (Monday – Friday, 9 a.m. to 5:30 p.m. UTC+8)
Fax: +886-2-2794-7327
E-mail: icg.support@advantech.com.tw
Web: www.advantech.com

Appendix C: Regulatory & Safety Information

Safety Notices



Please, observe the following instructions:

- The router must adhere to all relevant international and national laws, including any specific restrictions governing its use in designated applications and environments.
- To prevent potential injury and appliance damage, ensure compliance with regulations by using only authorized accessories. Unauthorized modifications or use of unapproved accessories could damage the router, violate regulations, and void the warranty.
- Do not attempt to open the router.
- Before handling the SIM card, turn off the router and disconnect it from the power supply.
- **Caution!** This equipment is not suitable for use in areas with children. Small children could swallow the SIM card.
- Ensure the power supply does not exceed 48 V DC maximum.
- Avoid exposing the router to extreme ambient conditions. Safeguard it against dust, moisture, and high temperatures.
- Only deploy routers with appropriate certification and labeling in environments containing flammable or explosive materials, such as gas stations, chemical plants, or areas involving explosives. Users must observe restrictions pertaining to radio device usage in such settings.
- When traveling by plane, switch off the router. Using it onboard could jeopardize flight operations, disrupt mobile networks, and potentially violate regulations. Non-compliance may result in telephone service suspension, cancellation, or legal repercussions.
- Exercise heightened caution when operating the router near personal medical devices like cardiac pacemakers or hearing aids.
- The router may cause interference when operated in close proximity to TV sets, radio receivers, or personal computers.
- It's advisable to create a suitable backup of all critical settings stored in the device's memory.



Product Disposal Instructions

The WEEE (Waste Electrical and Electronic Equipment: 2012/19/EU) directive was introduced to ensure that electrical/electronic products are recycled using the best available recovery techniques to minimize the environmental impact. This product contains high quality materials and components which can be recycled. At the end of its life this product **MUST NOT** be mixed with other commercial waste for disposal. The device contains a battery. Remove the battery from the device before disposal. The battery in the device needs to be disposed of apart accordingly. Check the terms and conditions of your supplier for disposal information.

Appendix D: Related Documents

[1] *ICR-2[78]00 Configuration Manual* (see *Documents to download* → *Manuals* section)



[EP] Product-related documents and applications can be obtained on **Engineering Portal** at <https://icr.advantech.com/download> address.



We, Advantech Czech s.r.o., declare that the radio equipment narrated in this user's manual complies with Directive **2014/53/EU**.



We, Advantech Czech s.r.o., declare that the radio equipment narrated in this user's manual complies with Radio Equipment Regulations 2017 (**S.I. 2017 No. 1206**).

The full text of the EU Declaration of Conformity is available at the following internet address:
icr.advantech.com/doc