



# Hardware Manual

## Industrial Cellular Router

### ICR-2412



© 2024 Advantech Czech s.r.o. No part of this publication may be reproduced or transmitted in any form or by any means, electronic or mechanical, including photography, recording, or any information storage and retrieval system without written consent. Information in this manual is subject to change without notice, and it does not represent a commitment on the part of Advantech.

Advantech Czech s.r.o. shall not be liable for incidental or consequential damages resulting from the furnishing, performance, or use of this manual.

All brand names used in this manual are the registered trademarks of their respective owners. The use of trademarks or other designations in this publication is for reference purposes only and does not constitute an endorsement by the trademark holder.

# Used symbols



Danger – Information regarding user safety or potential damage to the router.



Attention – Problems that can arise in specific situations.



Information – Useful tips or information of special interest.



# Contents

<b>1. Product Overview</b>	<b>1</b>
1.1 Product Introduction . . . . .	1
1.2 Usage Examples . . . . .	2
1.3 Hardware Overview . . . . .	6
1.4 Order Codes . . . . .	8
1.5 Product Revisions . . . . .	8
1.6 Package Contents . . . . .	9
1.7 Product Dimensions . . . . .	10
1.8 Mounting Recommendations . . . . .	12
1.9 Wall Mounting . . . . .	13
1.10 DIN Rail Mounting . . . . .	14
1.11 Product Label . . . . .	15
<b>2. Hardware Functionality</b>	<b>16</b>
2.1 SIM Card Slots . . . . .	16
2.2 Antennas . . . . .	17
2.3 Ethernet Interfaces . . . . .	17
2.4 Power Supply . . . . .	18
2.5 I/O Port Interfaces . . . . .	19
2.6 Serial Interfaces . . . . .	20
2.7 LED Status Indication . . . . .	21
2.8 Reset Functions . . . . .	22
<b>3. First Use</b>	<b>23</b>
3.1 Accessories Connection . . . . .	23
3.2 Router Configuration . . . . .	23
<b>4. Technical Specifications</b>	<b>24</b>
4.1 Basic Parameters . . . . .	24
4.2 Standards and Regulations . . . . .	25
4.3 Type Tests and Environmental Conditions . . . . .	26
4.4 Parameters of Cellular Module . . . . .	27
4.5 Parameters of I/O Ports . . . . .	28
4.6 Parameters of Serial Interfaces . . . . .	28
4.7 System Configuration . . . . .	29
<b>Appendix A: Troubleshooting</b>	<b>30</b>
<b>Appendix B: Customer Support</b>	<b>33</b>
<b>Appendix C: Regulatory &amp; Safety Information</b>	<b>34</b>
<b>Appendix D: Related Documents</b>	<b>35</b>

# List of Figures

1	Cellular Internet Access . . . . .	2
2	Backup for Internet Access . . . . .	3
3	VPN Networks Interconnection . . . . .	4
4	Serial Gateway . . . . .	5
5	Router Hardware Overview: Front View . . . . .	6
6	Router Hardware Overview: Rear View . . . . .	7
7	Router Dimensions – Top, Side and Front View with Wall Mount Clip . . . . .	10
8	Router Dimensions – Top, Side and Front View with DIN Rail Clip . . . . .	11
9	Screwed Wall Mounting Clip . . . . .	13
10	Position of the DIN Rail Clip . . . . .	14
11	Removing Router from the DIN Rail . . . . .	14
12	Product Label . . . . .	15
13	SIM Cards Insertion . . . . .	16
14	Ethernet Connector Pinout . . . . .	17
15	Connection of Power Supply . . . . .	18
16	Position of the Grounding Screw . . . . .	18
17	I/O Connector Pinout . . . . .	19
18	Functional Scheme of the Digital Interface . . . . .	19
19	RS485 and RS232 Pinout . . . . .	20
20	Resetting the Router . . . . .	22

# List of Tables

1	Router Hardware Overview: Front View . . . . .	6
2	Router Hardware Overview: Rear View . . . . .	7
3	Order Codes Overview . . . . .	8
4	HW Revisions History . . . . .	8
5	Contents of Package . . . . .	9
6	Ethernet Connector Pinout Description . . . . .	17
7	Power Supply Pinout . . . . .	18
8	I/O Ports Pinout . . . . .	19
9	Connection of RS485 . . . . .	20
10	Connection of RS232 . . . . .	20
11	LED Status Indication . . . . .	21
12	Basic Parameters . . . . .	24
13	Standards and Regulations . . . . .	25
14	Type Tests and Environmental Conditions . . . . .	26
15	Technical Parameters of Cellular Module . . . . .	27
16	Electrical Characteristics of Digital Input . . . . .	28
17	Parameters of Serial Interfaces . . . . .	28
18	System Configuration . . . . .	29

# 1. Product Overview

## 1.1 Product Introduction

Industrial cellular router ICR-2412 is designed for wireless communication in mobile networks that use traditional cellular technologies.

Industrial cellular router ICR-2412 is designed for wireless communication in the LPWA mobile networks LTE **Cat-M/Cat-NB** with fallback to the traditional 2G GPRS/EDGE network. GPRS/EDGE 2G standard allows deployment at places where LTE Cat-M/Cat-NB signal coverage is still under development.

ICR-2412 is the ideal gateway for global IoT applications because of the large number of cellular frequency bands supported. Among others, the router supports also the **European LTE 450 MHz** spectrum (bands B31 and B72) that is a key frequency for wireless communication in critical infrastructure e.g. in Energy distribution.

The router is equipped with two independently configurable **Ethernet ports**, **RS232** and **RS485** serial ports and with one **digital input** together with one **digital output**.

Router configuration is accessible through a **secure web interface**, offering detailed insights into the entire configuration, statuses, signal strength, and logs.

Basic features include **two-factor authentication**, **IPv6 Dual Stack**, **DHCP**, **NAT**, **NAT-T**, **DynDNS**, **DNS proxy**, **VLAN**, **QoS**, **NTP**, **VRRP**, **SMS control**, **port forwarding**, and **connection backup**, among others. The router supports various VPN protocols, including **IPSec**, **OpenVPN**, **GRE**, **L2TP**, and **PPTP**, ensuring secure communication.

The router allows for the insertion of **Linux scripts** for automated tasks. It supports the definition of up to **four distinct profiles**, switchable via the web interface, SMS, or digital input.

**Router Apps** enhance router functionality through custom software programs. For Advantech routers, a diverse array of Router Apps is offered, encompassing categories such as connectivity, routing, services, among others, freely accessible on the Advantech [Router Apps](#) webpage. Additionally, directly from the router web interface, you can use an **Advantech public server** for the Router App or router firmware installation/update.

Compatibility with Advantech's **remote device management** platforms, [WebAccess/DMP](#) and [WebAccess/VPN](#), offers extensive device management and monitoring, ensuring that devices remain up-to-date and secure.

## 1.2 Usage Examples

### Cellular Internet Access

- This example demonstrates a common scenario where the cellular router facilitates access from a local LAN to the Internet via the cellular network.
- This functionality is not available on LAN routers lacking a cellular interface.

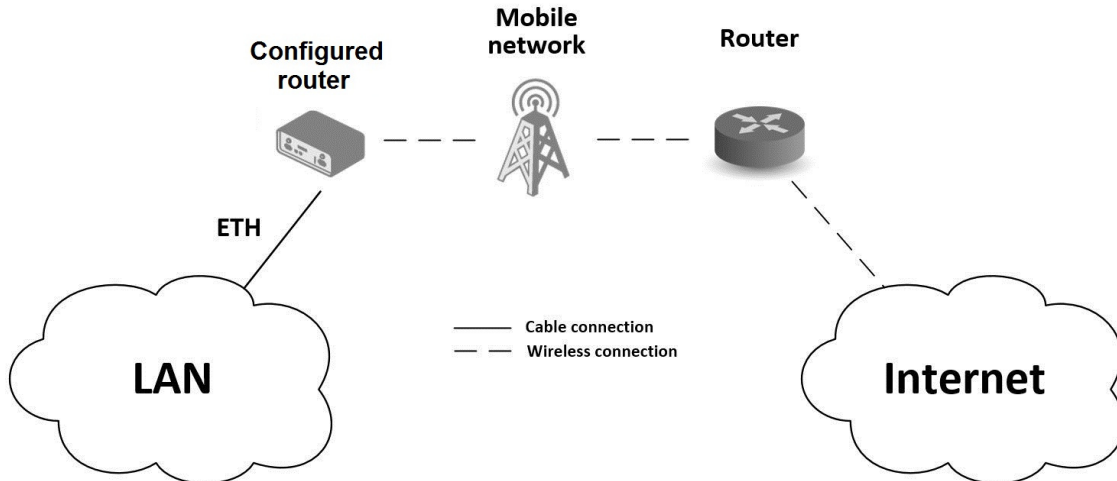

Figure 1: Cellular Internet Access



### Backup for Internet Access

- This example showcases how a cellular router's Internet access can be backed up.
- Backup options include PPPoE connections or Ethernet wired connections.

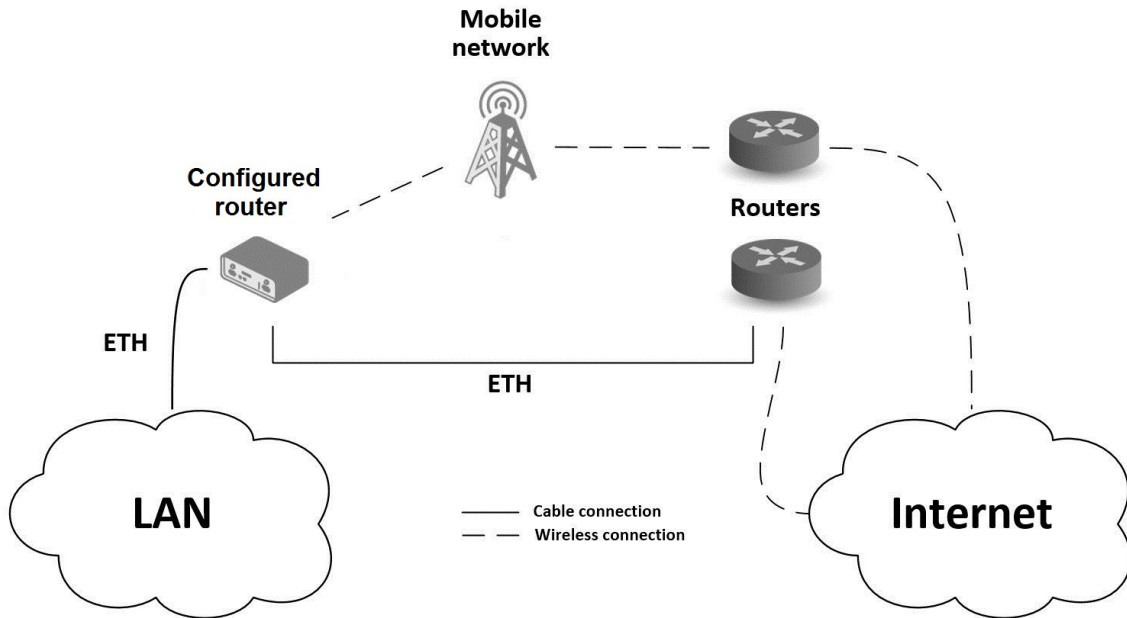

Figure 2: Backup for Internet Access

### VPN Networks Interconnection

- This example highlights the establishment of a secure VPN tunnel for interconnecting the configured Advantech router with a router in a remote network, facilitated via the Internet.
- The configured router connects to the Internet using the cellular network.

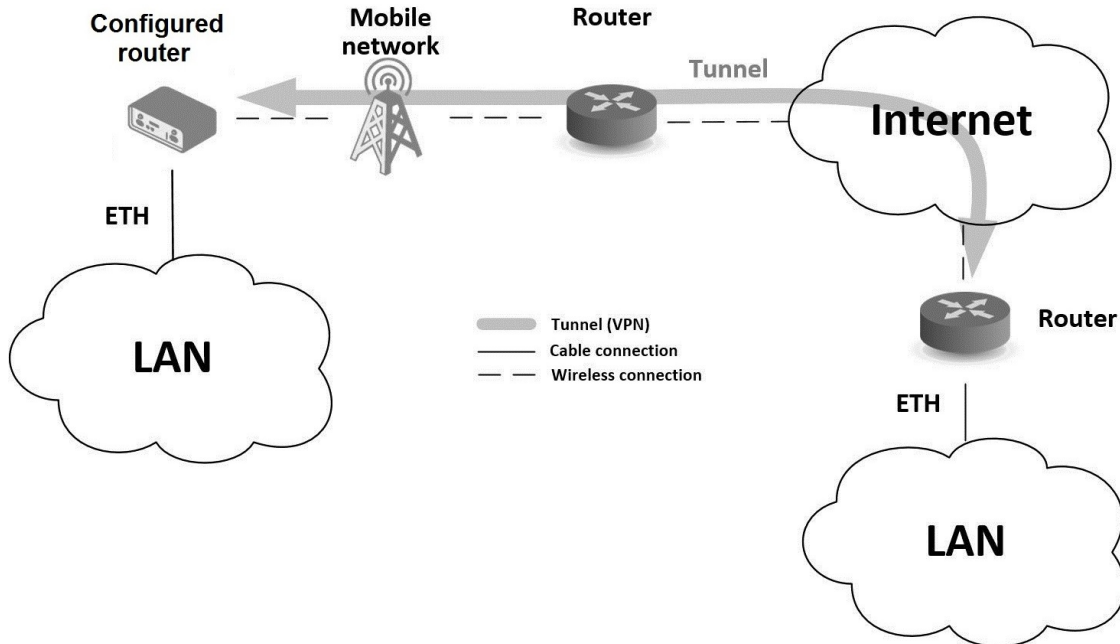

Figure 3: VPN Networks Interconnection

### Serial Gateway

- This example depicts a scenario where the configured Advantech router grants access to a PLC device interfaced serially with the router.
- The PLC device, accessible over the entire Internet network, can be controlled from a remote local network, such as one running a SCADA system.
- This functionality is exclusive to routers equipped with a serial interface.

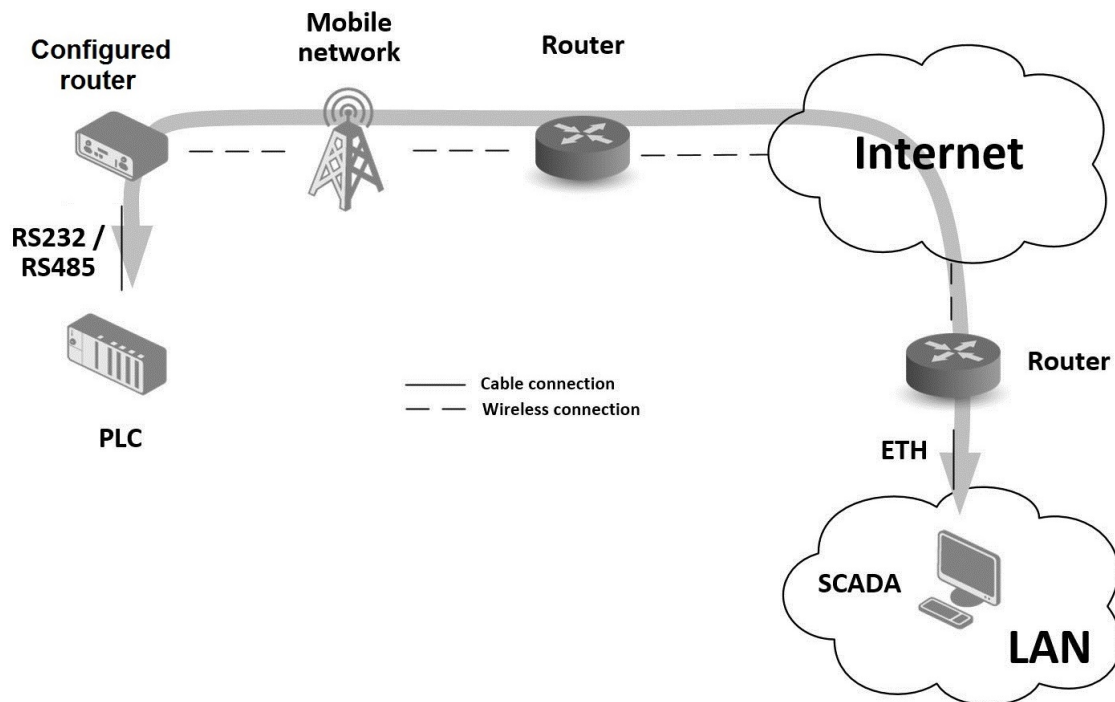

Figure 4: Serial Gateway

### 1.3 Hardware Overview

In this chapter, all components of the router case are described, including links to chapters that provide more details.

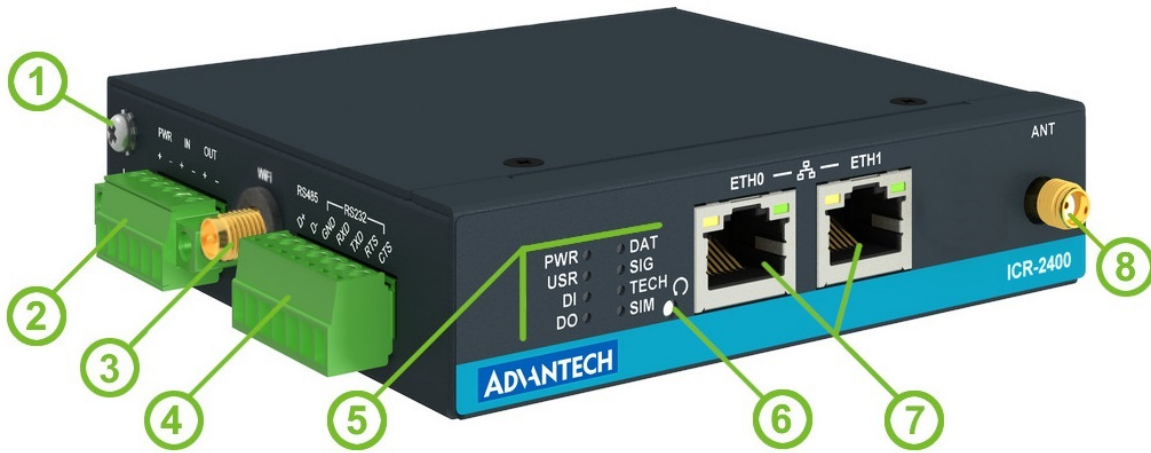

Figure 5: Router Hardware Overview: Front View

#	Item/Caption	Type	Description
1	Grounding screw	M3	Pay attention to proper grounding; see Chapter 2.4.
2	PWR IN/OUT	6-pin terminal	Power supply, digital input, and digital output interfaces. See Chapter 2.4, Chapter 2.5, Chapter 2.6 for more information, Chapter 4.5 for I/O parameters, and Chapter 4.6 for serial interface parameters .
3	RS485/RS232	7-pin terminal	RS232 & RS485 serial interfaces; see Chapter 2.6.
4	LEDs	-	Status LED indication; see Chapter 2.7.
5	RST	-	Button to reboot the router or to restore the default configuration; see Chapter 2.8.
6	ETH0 ETH1	RJ45 RJ45	100 MB Ethernet connections for the first and second LAN; see Chapter 2.3.
7	ANT	SMA female	Connector for the main antenna of the cellular module; see Chapter 2.2.

Table 1: Router Hardware Overview: Front View



Figure 6: Router Hardware Overview: Rear View

#	Item/Caption	Type	Description
8	SIM slots	Micro SIM	Two SIM card slots; see Chapter 2.1.
9	DIN clip	-	DIN rail clip, <b>not included</b> as standard accessories; see Chapter 1.10.
10	Wall clip	-	Wall mounting clip, included as standard accessories; see Chapter 1.9.

Table 2: Router Hardware Overview: Rear View

## 1.4 Order Codes

Order codes overview is shown in the table below.

Order code	Features – interfaces
ICR-2412	LTE Cat-M/Cat-NB with 3G/2G fallback cellular module, 64 MB NOR Flash, 2x ETH, 1x RS232, 1x RS485, 1x Digital Input, 1x Digital Output, 2x SIM reader

Table 3: Order Codes Overview

## 1.5 Product Revisions

For the product revision history of the entire product platform, refer to the table below. Please note that some revisions may not be available for certain order codes. The revision number is printed on both the packaging and product labels.

The router GUI can also display the product revision under *Status* → *General* → *System Information* → *Product Revision*. Please note that the default revision (Rev.1.0) is unavailable here.

Rev.#	Description
1.0	Initial version (revision number not printed on the labels).
2.0	New design of the mainboard; refer to <a href="#">PCN-2023-05</a> for details.
2.1	Changed the WiFi label on the chassis to "AUX"; refer to <a href="#">PCN-2024-05</a> for details.

Table 4: HW Revisions History

## 1.6 Package Contents

The standard set of router includes items listed in the following table:





Item#	Description	Figure	Q'ty
1	Router		1 pcs
2	Wall mounting clip with screws		1 set
3	6-pin terminal block for power supply, digital input and digital output (deployed on the router)		1 pcs
4	7-pin terminal block for RS485 and RS232 (deployed on the router)		1 pcs
5	Printed <i>Quick Start Guide Leaflet</i>		1 pcs

Table 5: Contents of Package

### 1.7 Product Dimensions

For the dimensions of the product see the figures below. Note that all sizes are measured in millimeters.

#### Variant with Wall Mounting Clip

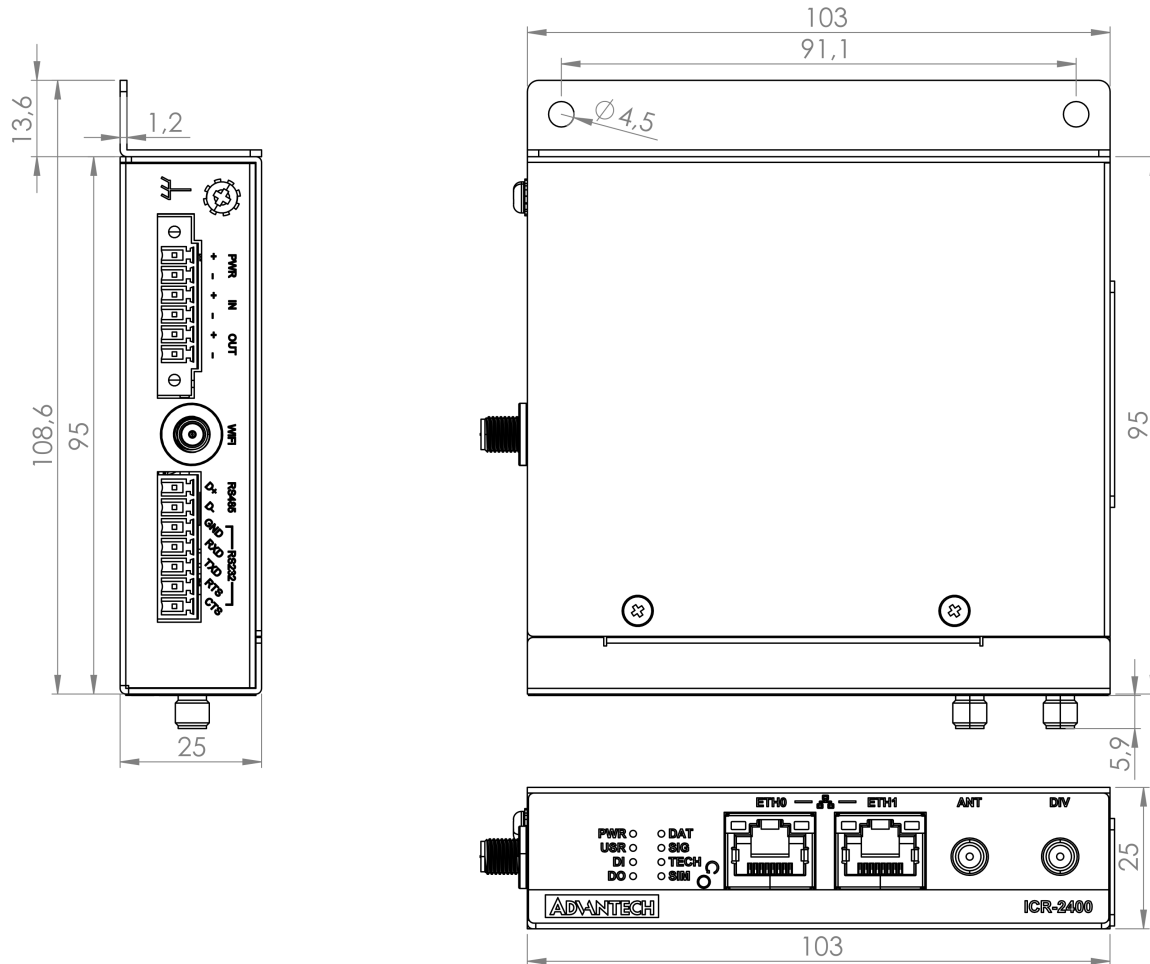

Figure 7: Router Dimensions – Top, Side and Front View with Wall Mount Clip



### Variant with DIN Rail Clip

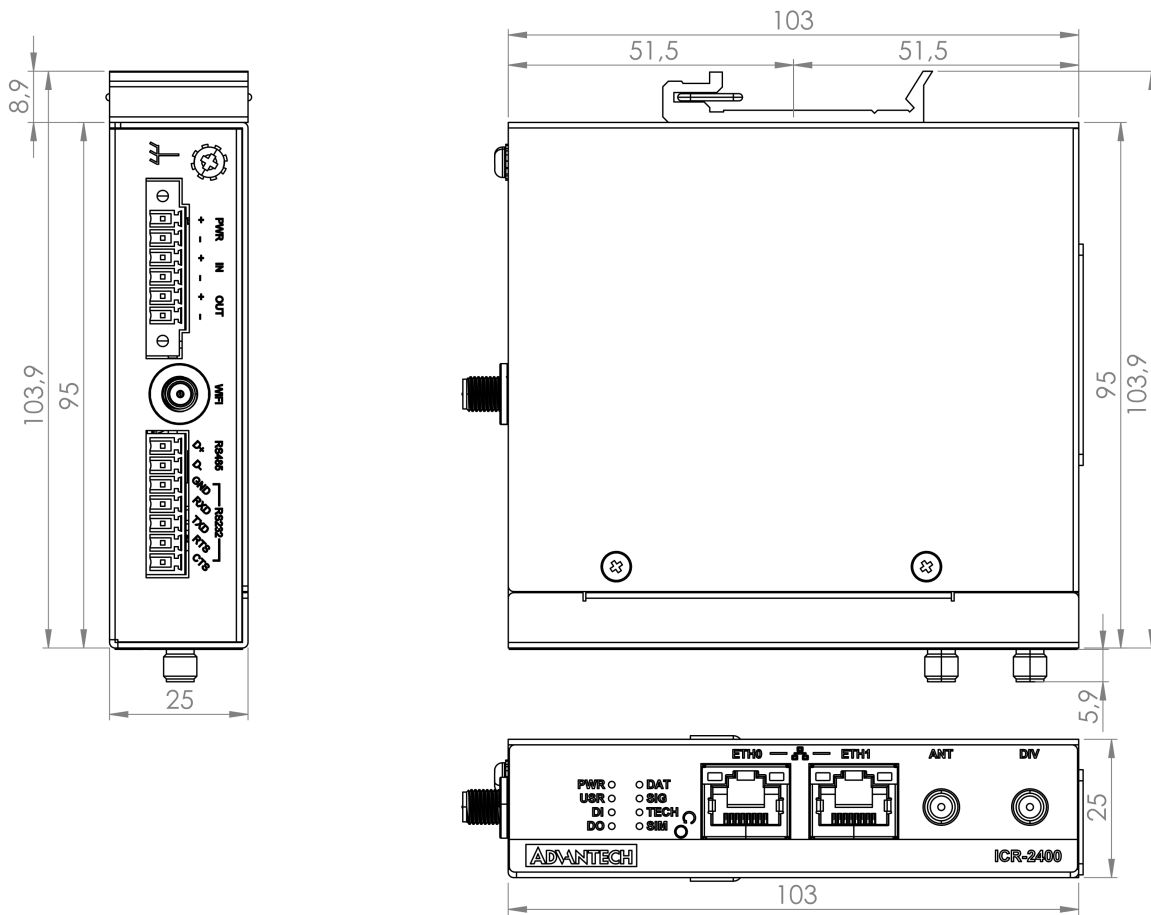

Figure 8: Router Dimensions – Top, Side and Front View with DIN Rail Clip

## 1.8 Mounting Recommendations

The router can be placed:

- on a flat surface,
- on a wall using the wall mounting clip (see Chapter 1.9),
- on a DIN rail EN 60715 with the metal DIN rail clip (see Chapter 1.10)

For most applications with a built-in router within a switchboard, it is possible to recognize two kinds of environments:

- A non-public, industry environment of low voltage with high interference,
- a public environment of low voltage and without high interference.

For both of these environments, it is possible to mount the router to a switchboard, after which there is no need to have examination immunity or issues in connection with EMC according to EN 61439-1:2011.



In compliance with the EN 61439-1:2011 specification, it is necessary to observe the following assembly instructions for a router attached to a switchboard:

- For whip antennas it is recommended to observe a minimum distance of 6 cm from cables and metal surfaces on every side in order to avoid interference. When using an external antenna separate from the switchboard it is necessary to fit a lightning conductor.
- When mounting a router on sheet-steel we recommend using a cable antenna.
- For all cables, we recommend to bind the bunch, and for this we recommend:
  - The length of the bunch (the combination of power supply and data cables) should be a maximum 1.5 m. If the length of data cables exceeds 1.5 m or if the cable is leading towards the switchboard, we recommend installing surge protectors.
  - Data cables must not have a reticular tension of  $\sim 230$  V/50 Hz or  $\sim 120$  V/60 Hz.
- Sufficient space must be left between each connector for the handling of cables,
- To ensure the correct functioning of the router we recommend the use of an earth-bonding distribution frame for the grounding of the grounding screw, see Chapter 2.4.

## 1.9 Wall Mounting

 The wall mounting clip is supplied with the router as standard accessories.

The router can be screwed to a wall (or another surface) using the wall mounting clip. There are two holes on the clip with a diameter of 4 millimeters. For detailed information about the mounting dimensions see Figure 7 in Chapter 1.7.

 When mounting the wall mounting clip, tighten the screws with max. torque of 0.4 Nm.

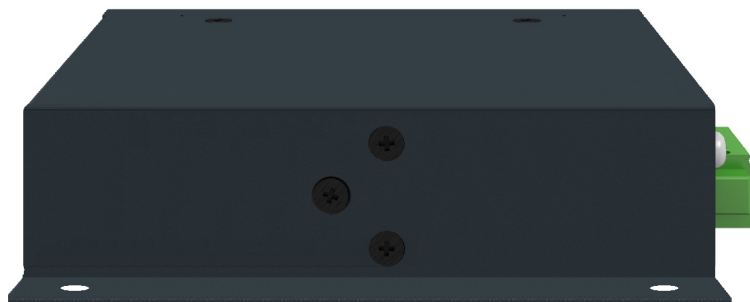

Figure 9: Screwed Wall Mounting Clip

## 1.10 DIN Rail Mounting



The DIN rail clip is not supplied with the router as standard accessories, but it can be ordered by the order code *BB-DIN-ICR32*.

The DIN rail clip is suitable for a DIN rail according to EN 60715 standard only. The default position of the clip is shown in Figure 10.



When mounting the DIN rail clip, tighten the screws with max. torque of 0.4 Nm.



Figure 10: Position of the DIN Rail Clip

To remove the router from the DIN rail it is necessary to lightly push down the router so that the bottom part of the DIN rail clip hitched to the DIN rail get out of this rail and then fold out the bottom part of the router away from the DIN rail, see Figure 11.

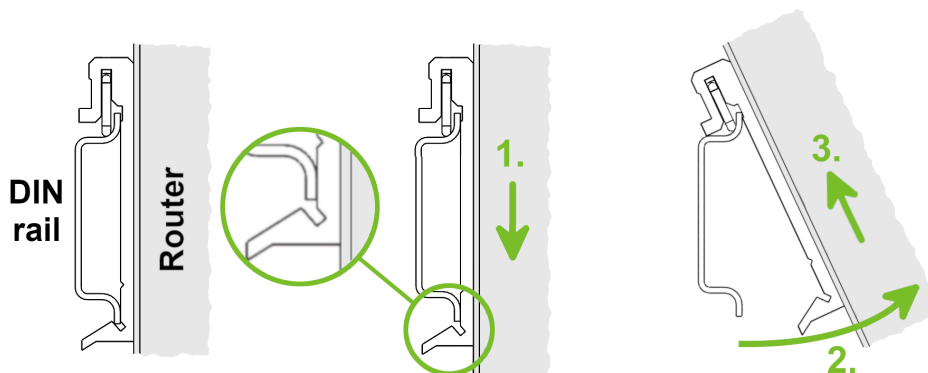

Figure 11: Removing Router from the DIN Rail

### 1.11 Product Label

The figure below shows an example of the product labels with all the information printed on them.

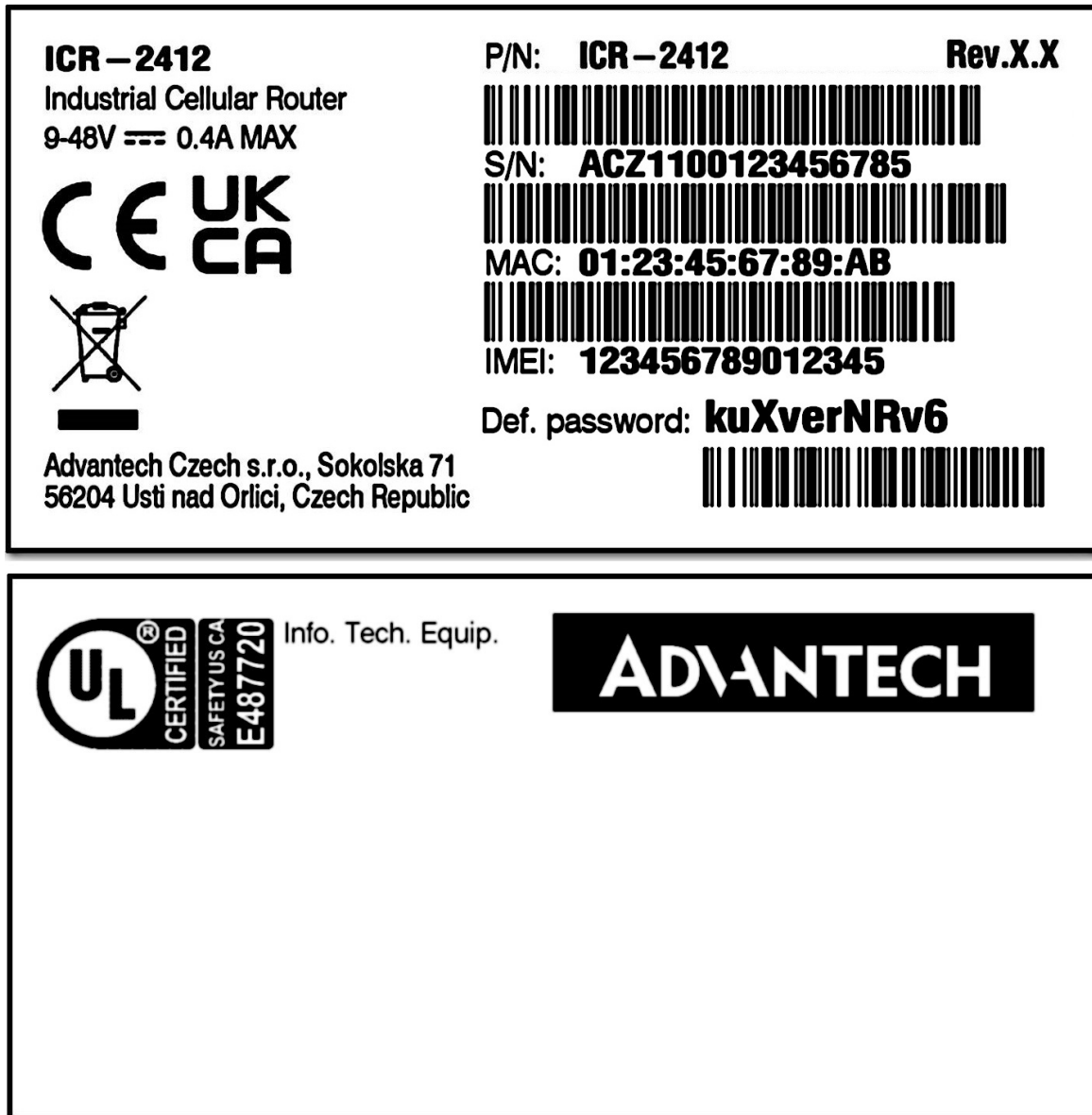

Figure 12: Product Label

## 2. Hardware Functionality

See Chapter 1.3 for an overview of the product's hardware, along with links to chapters offering detailed explanations.

### 2.1 SIM Card Slots

Slots for two SIM cards are located on the router beneath a metal cover. If you plan to use this device for cellular network communication, insert an activated data-provisioned SIM card into the SIM card slot.

You have the option to install two SIM cards simultaneously for utilizing the switching feature. The SIM cards can have different Access Point Names (APNs) configured. The procedure for changing SIM cards is outlined below. If the SIM requires a PIN, input it in the router's web interface (*Administration* → *Unlock SIM Card*).

 Type of SIM card: Micro SIM (3FF) 15.0 × 12.0 × 0.76 mm.

#### Inserting the SIM card:

- Always disconnect the router from the power supply before handling the SIM card.
- Unscrew the two screws on the SIM card cover and remove the cover.
- To remove an inserted SIM card, use the flat end of a spudger or your fingernail to press the SIM card slightly into its slot until you hear a click. Upon hearing the click, release the card, and it will pop out of its slot.
- To insert a SIM card, push the card into the slot until it clicks into place.
- Put the cover back and secure it with the two screws.

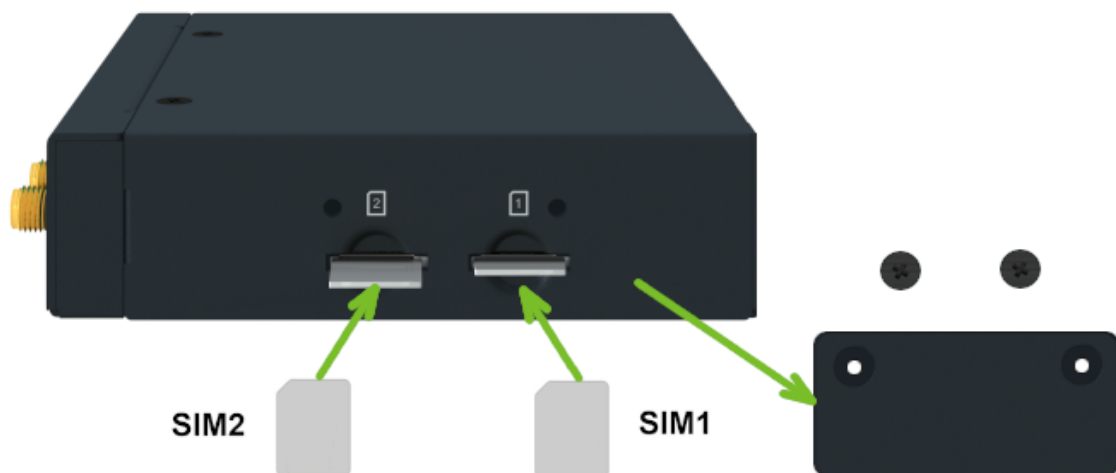

Figure 13: SIM Cards Insertion

## 2.2 Antennas

Connect cellular antenna to the router to main (ANT) SMA female connector.



Only run the router with a cellular antenna connected to the main antenna connector, as the energy from the transmission is effectively reflected by the open end and can damage the equipment.



The thread of the SMA connector for the WiFi antenna is connected to the internal ground, see Figure 18.



Recommended tightening moment for screwing the antenna to the SMA female connectors is 0.9 Nm.

## 2.3 Ethernet Interfaces

The panel socket of RJ45 is used for Ethernet interface. The pinout of the socket is shown in Figure 14 and described in Table 6.

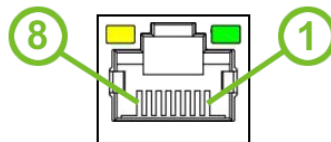

Figure 14: Ethernet Connector Pinout

Pin	Signal mark	Description
1	Tx+	Transmit Data+ (positive pole)
2	Tx-	Transmit Data- (negative pole)
3	Rx+	Receive Data+ (positive pole)
4	—	—
5	—	—
6	Rx-	Receive Data- (negative pole)
7	—	—
8	—	—

Table 6: Ethernet Connector Pinout Description



The isolation barrier of the Ethernet ports against the ground is 1500 V.

## 2.4 Power Supply

The power supply pins are physically connected to the 6-pin terminal block panel socket located on the left panel. The connection of the power supply is illustrated in Figure 15 and described in Table 7.

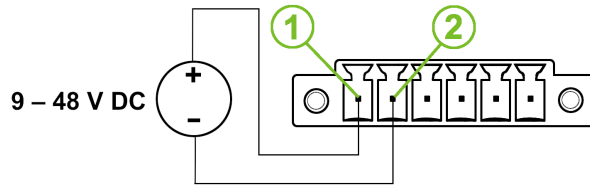

Figure 15: Connection of Power Supply

Pin	Signal mark	Description
1	PWR(+)	Positive pole of DC supply voltage (+9 to +48 V DC)
2	PWR(-)	Negative pole of DC supply voltage

Table 7: Power Supply Pinout

The required power supply voltage for the router ranges between +9 V and +48 V DC. Refer to the connection scheme in Figure 15 for proper setup. The router is equipped with built-in protection against reversed polarity, functioning without signaling. To guarantee correct operation, the power source must be capable of providing a sufficient amount of energy, as detailed in the consumption section of Chapter 4.1.



Unit has to be supplied by a power supply specified as a Limited Power Source (LPS) or CEC/NEC Class 2 source of supply.



The power supply (common pole) is not connected to the metal case of the router nor to the internal ground, see Figure 18.

If recommended for the installation environment, it is advised to protect the router by properly grounding it using the grounding screw, as illustrated in Figure 16.



Figure 16: Position of the Grounding Screw



## 2.5 I/O Port Interfaces

The pins of I/O interface are physically connected to the 6-pin terminal block panel socket located on the left panel. The pinout of one digital input and one digital output is shown in Figure 17 and described in Table 8.

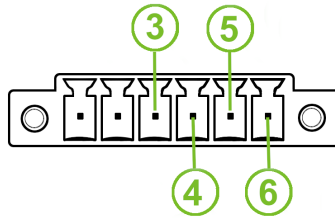

Figure 17: I/O Connector Pinout

Pin	Signal mark	Description
3	IN(+)	The digital input (positive pole)
4	IN(-)	The digital input (negative pole)
5	OUT(+)	The digital output (positive pole)
6	OUT(-)	The digital output (negative pole)

Table 8: I/O Ports Pinout

The I/O user interface is designed for digital input processing and digital output control. For detailed electrical parameters see Chapter 4.5. The functional scheme of connection for the digital input and digital output is in Figure 18.

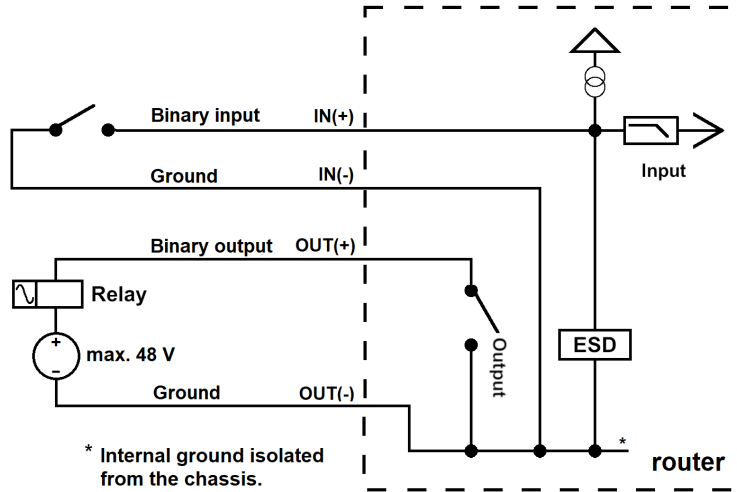

Figure 18: Functional Scheme of the Digital Interface

## 2.6 Serial Interfaces

The pins of RS232 and RS485 serial interfaces are physically connected to the 7-pin terminal block panel socket located on the left panel. The pinout of this connector is described in Figure 19 and in Table 9, resp. Table 10.

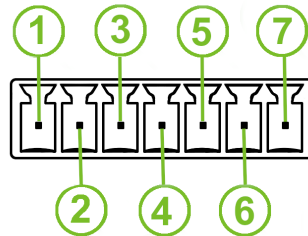

Figure 19: RS485 and RS232 Pinout

Pin	Signal mark	Description
1	D (+)	In/Out
2	D (-)	In/Out
3	GND	Ground (common with RS232)

Table 9: Connection of RS485

Pin	Signal mark	Description
3	GND	Ground (common with RS485)
4	RXD	Received Data
5	TXD	Transmit Data
6	RTS	Request to Send
7	CTS	Clear to Send

Table 10: Connection of RS232



The serial interfaces are not electrically isolated from the router. The ground is connected to the internal ground, see Figure 18.

## 2.7 LED Status Indication

There are LED indicators on the front panel of the router to provide router status information. Moreover, ETH connector, has two additional LEDs providing information about the port status.

Caption	Color	State	Description
PWR	Green	On	The router is booting up.
	Green	Blinking	The router booted up and is ready.
	Green	Fast blinking	The router firmware is being updated.
USR	Green	—	The function of this LED is user-defined.
DI	Green	On	The digital input is active.
DO	Green	On	The digital output is active.
DAT	Green	Blinking	Cellular communication is in progress.
SIG	Green	On	Good cellular signal.
		Blinking	Fair cellular signal.
		Fast blinking	Poor cellular signal.
TECH	Green	On	The active SIM uses 4G technology.
		Blinking	The active SIM uses 3G technology.
		Fast blinking	The active SIM uses 2G technology.
SIM	Green	On	SIM1 is active for the cellular connection.
		Blinking	SIM2 is active for the cellular connection.
		Fast blinking	A SIM issue (missing card or PIN not entered).
ETH0	Green	On	Selected 100 Mbps bit rate.
ETH1	Green	Off	Selected 10 Mbps bit rate.
ETH0 ETH1	Orange	On	The network cable is connected.
		Blinking	Data transmission.
		Off	The network cable is not connected.

Table 11: LED Status Indication

## 2.8 Reset Functions

The RST button has multiple functions depending on the firmware platform. For more information, see the configuration manual [1], chapter *Manual Introduction* → *Device* → *Reset*.

 Use a narrow screwdriver or any small tool to press the *RST* button.

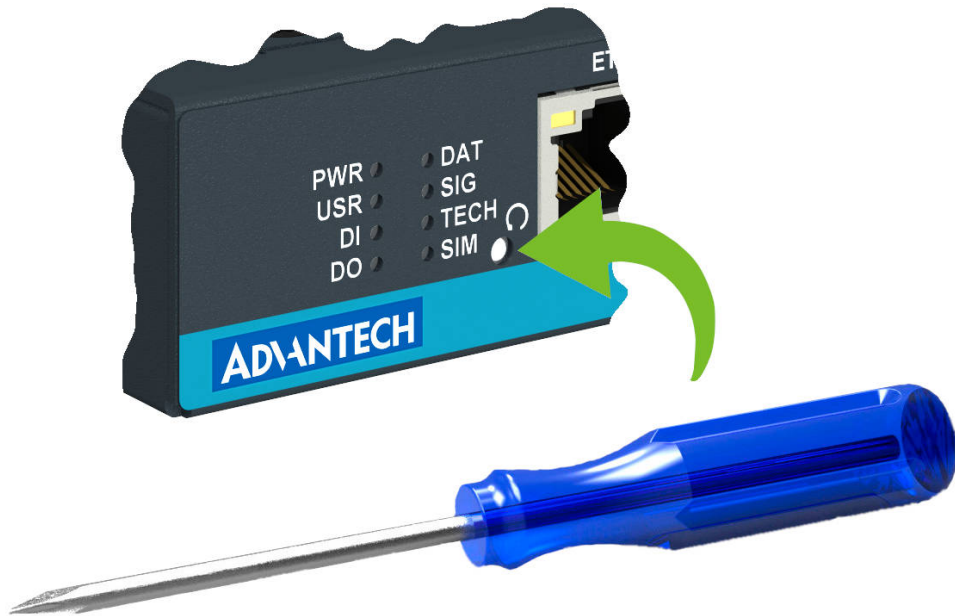

Figure 20: Resetting the Router

# 3. First Use

## 3.1 Accessories Connection

Before putting the router into operation, make sure to connect all the components required for running your applications. Refer to Chapter 1.3 for an overview of the hardware. Also, remember to insert a SIM card for the cellular connection as explained in Chapter 2.1.



Ensure you do not operate the router without an antenna connected to the main antenna connector. Transmitting energy is effectively reflected by the open end, which could potentially damage the equipment.

## 3.2 Router Configuration

You can perform the initial configuration of the router using a web browser on your PC. This interface allows for router monitoring, configuration, and administration.

Begin by connecting the power supply to the router (refer to Chapter 2.4). The router will initiate its boot process. By default, the router will automatically establish a connection to the default Access Point Name (APN) of the inserted SIM card. Ensure your PC is configured to obtain IP settings automatically from the network. Connect your PC's network card to the default LAN interface of the router, Ethernet port ETH0. The DHCP server will assign an IP address to your PC.

To access the router's web interface, enter the following address in your web browser: <https://192.168.1.1>.

1.1. Please note that using the HTTPS protocol for secure communication over the network is mandatory. The default user is `root`. Check the **product label** on the router for the **default password**. The user will be prompted to **change their password** when logging into the new router for the **first time**.



Consult the router **Configuration Manual [1]** for detailed descriptions and examples of router configuration.



For security reasons, we recommend regularly updating the router's firmware to the latest version. Downgrading the firmware to an older version than the production version or uploading firmware intended for a different device may cause the device to malfunction.



All routers have the *WebAccess/DMP* client pre-installed by default. The activated client periodically uploads router identifiers and configuration to the *WebAccess/DMP* server. See the configuration manual [1], chapter *Basic Information* → *WebAccess/DMP Configuration*, for more information.

# 4. Technical Specifications

## 4.1 Basic Parameters

Parameter		Description
Temperature range	Operating	-40 °C to +75 °C (-40 °F to +167 °F)
	Storage	-40 °C to +85 °C (-40 °F to +185 °F)
Humidity	Operating	5 to 95 % relative humidity non condensing
	Storage	5 to 95 % relative humidity non condensing
Altitude	Operating	2000 m / 70 kPa
Degree of protection		IP30
Supply voltage		9 to 48 V DC
Battery for RTC		CR2032 / CR1225 <sup>1</sup>
Consumption	Idle	2.0 W
	Average	2.4 W
	Maximum	2.9 W
Dimensions of device w/o clip		103 × 95 × 25 mm (4.06" × 3.74" × 0.98")
DIN rail clip (optional part) specification		DIN 35 mm, EN 60715
Weight	Box w/o clip	345 g (0.76 lbs) / 355 g (0.78 lbs)

Table 12: Basic Parameters

<sup>1</sup>For product revision 2.0 and higher.

## 4.2 Standards and Regulations

The router complies with the following standards and regulations:

Parameter	Description
Radio	EN 301 893, EN 300 328, EN 301 511, EN 301 908-1 , EN 301 908-13
EMC	EN 301 489-1, EN 301 489-17, EN 301 489-52, EN 61000-4-2, EN 61000-4-3, EN 61000-4-4, EN 61000-4-5, EN 61000-4-6, IEC 61000-6-2, IEC 61000-6-3, EN 55032
Safety	EN IEC 62368-1, EN IEC 62311, UL E487720, IEEE 802.3
National	CE, UKCA compliant
Environmental	REACH, RoHS3 and WEEE compliant

Table 13: Standards and Regulations

### 4.3 Type Tests and Environmental Conditions

Phenomena	Test	Description	Test levels
ESD	EN 61000-4-2	Enclosure	CD $\pm$ 6 kV, L3
RF field AM modulated	EN 61000-4-3	Enclosure	20 V/m, 80 MHz-1 GHz, LX 10 V/m, 1 GHz-6 GHz, L3
Fast transient	EN 61000-4-4	DC port ETH - FTP Digital input Digital output RS232 RS485	$\pm$ 1 kV, 5/50 Tr/Th ns, 100 kHz, L2 $\pm$ 1 kV, 5/50 Tr/Th ns, 100 kHz, L3 $\pm$ 1 kV, 5/50 Tr/Th ns, 100 kHz, L3 $\pm$ 1 kV, 5/50 Tr/Th ns, 100 kHz, L3 $\pm$ 1 kV, 5/50 Tr/Th ns, 100 kHz, L3 $\pm$ 1 kV, 5/50 Tr/Th ns, 100 kHz, L3
Surge	EN 61000-4-5	ETH RS485	$\pm$ 1 kV, 1.2/50(8/20) Tr/Th us, L2 $\pm$ 1 kV, 1.2/50(8/20) Tr/Th us, L2
RF conducted	EN 61000-4-6	DC port ETH I/O ports RS232 RS485	10 V, 0.15-80 MHz, 80%AM(1kHz), L3 10 V, 0.15-80 MHz, 80%AM(1kHz), L3 10 V, 0.15-80 MHz, 80%AM(1kHz), L3 10 V, 0.15-80 MHz, 80%AM(1kHz), L3 10 V, 0.15-80 MHz, 80%AM(1kHz), L3
Radiated emission	EN 55032	Enclosure	Class B, 30 MHz-1 GHz, 1 GHz-6 GHz
Conducted emission	EN 55032	DC power port Ethernet ports Serial ports RS232 RS485	Class B, 150 kHz-30 MHz Class B, 150 kHz-30 MHz Class B, 150 kHz-30 MHz Class B, 150 kHz-30 MHz Class B, 150 kHz-30 MHz
Dry heat	EN 60068-2-2	Operating Storage	Test Bb, storage +75 °C Test Bd, operation +85 °C
Cold	EN 60068-2-1	Operating Storage	Test Ab, storage -40 °C Test Ad, operation -40 °C
Variation of temperature	EN 60068-2-14	Test Nb, -40 °C / +75 °C, 3h/3h, 2 cycles, 3 K/min	
Dry heat, cyclic	EN 60068-2-30	+55 °C / +25 °C, rel. humidity 95 %, 6 h-6 h	

Table 14: Type Tests and Environmental Conditions



## 4.4 Parameters of Cellular Module

Parameter	Description
Antenna	Connector type: SMA Impedance: 50 $\Omega$
Cat-M/NB parameters	Cat-M frequencies: B31 & B72 (450 MHz), B12 & B13 & B14 & B28 & B85 (700 MHz), B20 & B27 (800 MHz), B5 & B18 & B19 & B26 (850 MHz), B8 (900 MHz), B4 & B66 (1700 MHz), B3 (1800 MHz), B2 & B25 (1900 MHz), B1 (2100 MHz) Cat-M bit rates: up to 589 Kbps (DL), 1119 Kbps (UL) Cat-NB frequencies: B31 (450 MHz), B12 & B13 & B28 & B85 (700 MHz), B20 (800 MHz), B5 & B18 & B19 & B26 (850 MHz), B8 (900 MHz), B4 & B66 (1700 MHz), B3 (1800 MHz), B2 & B25 (1900 MHz), B1 (2100 MHz) Cat-NB bit rates: up to 127 Kbps (DL), 158.5 Kbps (UL)
EDGE/GPRS parameters	Supported frequencies: B5 (850 MHz), B8 (900 MHz), B3 (1800 MHz), B2 (1900 MHz) Bit rates: up to 296 kbps (DL) / 236.8 kbps (UL)

Table 15: Technical Parameters of Cellular Module

## 4.5 Parameters of I/O Ports

Electrical characteristics of the digital input are in Table 16. Status of the digital input is reported in the GUI on *General Status* page or can be retrieved in the Shell via `io get bin0` command.

get command output	Voltage	Web interface status
0	$\leq 0.8\text{ V}$ (0.5 mA))	On
1	$\geq 2\text{ V}$	Off

Table 16: Electrical Characteristics of Digital Input

The maximum digital output load is **100 mA** at **9 – 48 V**.

## 4.6 Parameters of Serial Interfaces

Supported parameters of the RS232 and RS485 interfaces, which can be configured in *Expansion Port 1* resp. *Expansion Port 2* menu items, are in Table 17.

Parameter	Description
Baudrate	300, 600, 1200, 2400, 4800, 9600, 19200, 38400, 57600, 115200, 230400.
Data Bits	5, 6, 7, 8.
Parity	none, even, odd.
Stop Bits	1, 2.
Flow Control	none, hardware.

Table 17: Parameters of Serial Interfaces

## 4.7 System Configuration

The main parameters of the system are listed in Table 18.

Parameter	Description
CPU architecture	ARM926EJ-S
CPU frequency	600 MHz
CPU power	4,72 DMIPS/MHz
Flash memory	64 MB NOR Flash <ul style="list-style-type: none"><li>• 12 MB for Router Apps</li><li>• 2 MB for customer data</li></ul>
RAM size	128 MB
Watchdog	HW Watchdog
RTC	Battery Backup RTC

Table 18: System Configuration

# Appendix A: Troubleshooting

If you cannot connect to the router from your PC, your network card may be configured in such a way that it is not possible to connect to the router. Take one or more of the following steps in order to solve the problem:

- Make sure your PC's network card is configured to obtain the IP address from the DHCP server (by default the DHCP server is running in the router).
- Connect the router to the PC via Switch.
- Connect the router to the PC, start the router first and then start the PC after the router's initialization.

## Ethernet connection fails or is not establishing.

- It is possible to turn auto negotiation off and set a rate and duplex manually on the Ethernet interface of the router. Available on "LAN Configuration" page in the router.

## Mobile WAN connection fails.

- Check the signal power ("Mobile WAN status" page). If the signal power is weak, you will have to use a better antenna. If the neighbouring cells have a similar signal strength, you will need to use a directional antenna. For proper operation, the signal levels have to be good.
- Try to enable automatic ping from the router, which will check the connection when there are no data running and in the case of a failed ping, restart the connection. This can be done on the "Mobile WAN Configuration" page in the router in the "Check connection" section. "Enable + bind" option is to ensure the ping goes always through Mobile WAN network interface.

## Mobile WAN connection cannot be established.

- Check the "Mobile WAN Configuration" – APN, name, password and IP address (all can be blank).
- Try to enter the SIM card PIN – verify that the SIM card has the PIN code entered. Available on "Unlock SIM Card" page in the "Administration" section.
- In a private APN it is not recommended to get the DNS settings from operator (on "Mobile WAN" page)
- Go to "System Log" page in "Status" section and observe where the error occurs.

## I cannot connect from the Internet to the device behind the router. I have NAT enabled.

- The device's gateway has to be configured so it points to the router.

## I can't access my Web server placed behind the router over NAT.

- The remote HTTP access to the router has to be disabled on "NAT Configuration" page in the router. Also enable "Send all remaining incoming packets to default server" feature and fill in the IP address of your Web server. On the Web server, the default gateway has to be the IP address of the router.

## DynDNS doesn't work.

- With private APN this will not work.

- If the same IP address is recorded in your canonic name as a dynamically assigned address, it means that the operator is using NAT or a firewall.
- You can verify NAT using ping to your server with static address and then compare with router's IP address.
- You can verify a Firewall by accessing remotely to the router's Web interface.
- The operator may not provide the address of DNS server and without DNS server's address it is impossible to connect to the dyndns.org server. The following messages will be shown in the System Log:
  - DynDNS daemon started
  - Error resolving hostname: no such file or directory
  - Connect to DynDNS server failed

 **L2TP or IPSec isn't establishing.**

- Check the "System Log" page for error messages.

 **IPSec tunnel establishes but the communication does not run.**

- Probably there are bad routing rules defined in the connected devices, or the default gateway.

 **I switched the router to offline mode by SMS message, but the router is in online mode after reboot.**

- SMS messages do not change the router configuration. They remain in effect only until the router is rebooted.

### **Serial communication is not working.**

- Verify that the router model supports serial communications. Also verify the serial communication settings. To do so, open the router's configuration menu via the web browser, select the appropriate "Expansion Port" from "Configuration" part of the menu and verify the settings.

### **Is the router Cisco compatible? Can I use the Cisco configuration?**

- No, the Firmware in the router (ICR-OS) is based on Linux with BusyBox. Thus the Cisco configuration cannot be used. But network connections are defined by standards so connecting the router to the Cisco or other networking devices is possible and will be compatible.

### **FTP or SFTP does not work**

- FTP will work on v2 routers only. You can use SFTP on all routers to transfer files to/from the router. If having troubles with FTP on v2 routers, make sure you have FTP enabled: "Configuration" section, "Services", "FTP". Then you can connect with any client on port 21 with name and password same as for the Web interface. If having troubles with SFTP, make sure you have SSH enabled: "Configuration" section, "Services", "SSH". Then you can connect with any client on port 22 with name and password same as for the Web interface.

### **How can I connect to the router's command line? (SSH, Telnet)**

- You can use SSH on all routers or Telnet on v2 routers only. SSH is enabled by default, but you can verify in Web interface in "Configuration" section, "Services", "SSH". Then connect with any SSH client on port 22 of the router. User and password is the same as for the Web interface. Telnet on v2 routers can be enabled here: "Configuration" section, "Services", "Telnet".

# Appendix B: Customer Support

## Customer Support for Europe

### Advantech Czech s.r.o.

Sokolska 71  
562 04, Usti nad Orlici  
Czech Republic

Phone: +353 91 792444  
Fax: +353 91 792445  
E-mail: [iiotcustomerservice@advantech.eu](mailto:iiotcustomerservice@advantech.eu)  
Web: [www.advantech.com](http://www.advantech.com)

## Customer Support for NAM

### Advantech B+B SmartWorx

707 Dayton Road  
Ottawa, IL 61350 USA

Phone: +1-800-346-3119 (Monday – Friday, 7 a.m. to 5:30 p.m. CST)  
Fax: +1-815-433-5109  
E-mail: [support.iiot.ana@advantech.com](mailto:support.iiot.ana@advantech.com)  
Web: [www.advantech.com](http://www.advantech.com)

## Customer Support for Asia

Phone: +886-2-2792-7818 #1299 (Monday – Friday, 9 a.m. to 5:30 p.m. UTC+8)  
Fax: +886-2-2794-7327  
E-mail: [icg.support@advantech.com.tw](mailto:icg.support@advantech.com.tw)  
Web: [www.advantech.com](http://www.advantech.com)

# Appendix C: Regulatory & Safety Information

## Safety Notices



Please, observe the following instructions:

- The router must adhere to all relevant international and national laws, including any specific restrictions governing its use in designated applications and environments.
- To prevent potential injury and appliance damage, ensure compliance with regulations by using only authorized accessories. Unauthorized modifications or use of unapproved accessories could damage the router, violate regulations, and void the warranty.
- Do not attempt to open the router.
- Before handling the SIM card, turn off the router and disconnect it from the power supply.
- **Caution!** This equipment is not suitable for use in areas with children. Small children could swallow the SIM card.
- Ensure the power supply does not exceed 48 V DC maximum.
- Avoid exposing the router to extreme ambient conditions. Safeguard it against dust, moisture, and high temperatures.
- Only deploy routers with appropriate certification and labeling in environments containing flammable or explosive materials, such as gas stations, chemical plants, or areas involving explosives. Users must observe restrictions pertaining to radio device usage in such settings.
- When traveling by plane, switch off the router. Using it onboard could jeopardize flight operations, disrupt mobile networks, and potentially violate regulations. Non-compliance may result in telephone service suspension, cancellation, or legal repercussions.
- Exercise heightened caution when operating the router near personal medical devices like cardiac pacemakers or hearing aids.
- The router may cause interference when operated in close proximity to TV sets, radio receivers, or personal computers.
- It's advisable to create a suitable backup of all critical settings stored in the device's memory.



## Product Disposal Instructions

The WEEE (Waste Electrical and Electronic Equipment: 2012/19/EU) directive was introduced to ensure that electrical/electronic products are recycled using the best available recovery techniques to minimize the environmental impact. This product contains high quality materials and components which can be recycled. At the end of its life this product **MUST NOT** be mixed with other commercial waste for disposal. The device contains a battery. Remove the battery from the device before disposal. The battery in the device needs to be disposed of apart accordingly. Check the terms and conditions of your supplier for disposal information.



# Appendix D: Related Documents

[1] [ICR-2\[0456\]00 Configuration Manual](#)



[EP] Product-related documents and applications can be obtained on **Engineering Portal** at <https://icr.advantech.com/download> address.



We, Advantech Czech s.r.o., declare that the radio equipment narrated in this user's manual complies with Directive **2014/53/EU**.



We, Advantech Czech s.r.o., declare that the radio equipment narrated in this user's manual complies with Radio Equipment Regulations 2017 (**S.I. 2017 No. 1206**).

The full text of the EU Declaration of Conformity is available at the following internet address:  
[icr.advantech.com/eudoc](http://icr.advantech.com/eudoc)