

## Hardware Manual

### 5G Industrial Router

### ICR-4453

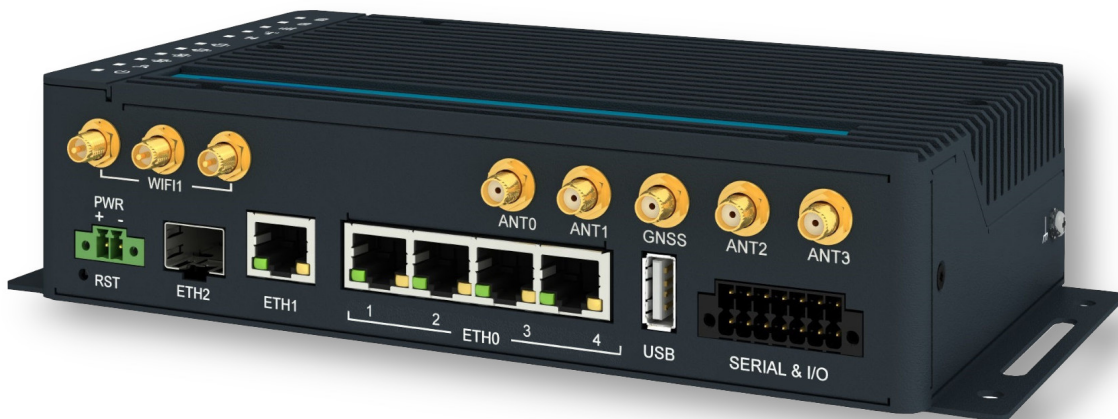

© 2025 Advantech Czech s.r.o. No part of this publication may be reproduced or transmitted in any form or by any means, electronic or mechanical, including photography, recording, or any information storage and retrieval system without written consent. Information in this manual is subject to change without notice, and it does not represent a commitment on the part of Advantech.

Advantech Czech s.r.o. shall not be liable for incidental or consequential damages resulting from the furnishing, performance, or use of this manual.

All brand names used in this manual are the registered trademarks of their respective owners. The use of trademarks or other designations in this publication is for reference purposes only and does not constitute an endorsement by the trademark holder.

# Used symbols



Danger – Information regarding user safety or potential damage to the router.



Attention – Problems that can arise in specific situations.



Information – Useful tips or information of special interest.



# Contents

<b>1. Product Overview</b>	<b>1</b>
1.1 Product Introduction	1
1.2 Hardware Overview	2
1.3 Order Codes	4
1.4 Product Revisions	4
1.5 Package Contents	5
1.6 Product Dimensions	6
1.7 Mounting Recommendations	8
1.8 Wall Mounting	9
1.9 DIN Rail Mounting	10
1.10 Product Label	11
1.11 First Use	12
<b>2. Hardware Functionality</b>	<b>13</b>
2.1 SIM Card Slots	13
2.2 Antennas Interfaces	14
2.3 Ethernet Interfaces	14
2.4 Power over Ethernet (PoE) PSE	15
2.5 SFP Cage	17
2.6 Power Supply	18
2.7 Low Power Mode	19
2.8 I/O Port Interfaces	20
2.9 Serial Interfaces	21
2.10 USB Port	22
2.11 MicroSD Card Reader	23
2.12 LED Status Indication	24
2.13 Reset Functions	25
<b>3. Technical Parameters</b>	<b>26</b>
3.1 Basic Parameters	26
3.2 Standards and Regulations	27
3.3 Type Tests and Environmental Conditions	28
3.4 Parameters of Cellular Module	29
3.4.1 Module Antenna Mapping	31
3.5 Parameters of GNSS	32
3.6 Parameters of WiFi	33
3.7 Parameters of I/O Ports	34
3.8 Parameters of Serial Interfaces	34
3.9 Parameters of PoE	35
3.10 System Configuration	35
<b>Appendix A: Troubleshooting</b>	<b>36</b>
<b>Appendix B: Customer Support</b>	<b>39</b>

**Appendix C: Regulatory & Safety Information**

**40**

**Appendix D: Related Documents**

**41**

# List of Figures

1	Router Hardware Overview – Front View . . . . .	2
2	Router Hardware Overview – Rear View . . . . .	3
3	Router Dimensions – Front, Top and Right view with Wall Mounting holder . . . . .	6
4	Router Dimensions – Front, Top and Right view with DIN holder . . . . .	7
5	Rotated Wall Mounting Clips . . . . .	9
6	Default Position of the DIN Rail Clips . . . . .	10
7	Removing Router from the DIN Rail . . . . .	10
8	Product Label . . . . .	11
9	SIM Cards Insertion . . . . .	13
10	Ethernet Connector Pinout of RJ45 Socket . . . . .	14
11	PoE PSE Funcional Scheme . . . . .	15
12	SFP Module Installation . . . . .	17
13	Power Connector Pinout . . . . .	18
14	Position of the Grounding Screw . . . . .	18
15	I/O Connector Pinout . . . . .	20
16	Functional Scheme of the Digital Interface . . . . .	20
17	Serial Connector Pinout . . . . .	21
18	USB Connector Pinout . . . . .	22
19	MicroSD Card Insertion . . . . .	23
20	Resetting the Router . . . . .	25

# List of Tables

1	Router Hardware Overview – Front View . . . . .	2
2	Router Hardware Overview – Rear View . . . . .	3
3	Order Codes Overview . . . . .	4
4	HW Revisions History . . . . .	4
5	Contents of Package . . . . .	5
6	Ethernet Connector Pinout Description of RJ45 Socket . . . . .	14
7	PoE PSE Parameters . . . . .	16
8	Tested SFP Modules . . . . .	17
9	Power connector pinout . . . . .	18
10	Connection of I/O Ports . . . . .	20
11	Connection of RS232 . . . . .	21
12	Connection of CAN Bus . . . . .	21
13	Connection of RS485 . . . . .	21
14	USB Connector Pinout . . . . .	22
15	Technical Specifications of MicroSD Card . . . . .	23
16	LED Status Indication . . . . .	24
17	Basic Parameters . . . . .	26
18	Standards and Regulations . . . . .	27
19	Type Tests and Environmental Conditions . . . . .	28
20	Technical Parameters of Cellular Module . . . . .	30
21	Cellular Module Antenna Mapping . . . . .	31
22	Technical Parameters of GNSS . . . . .	32
23	Technical Parameters of WiFi . . . . .	33
24	Electrical Characteristics of Digital Input . . . . .	34
25	Parameters of Serial Interfaces . . . . .	34
26	System Configuration . . . . .	35

# 1. Product Overview

## 1.1 Product Introduction

The ICR-4453 is an Ultra-high-speed **5G NR** (New Radio) Router and **Powerful Edge Computing Gateway** focused on the global market.

Thanks to its ultra high-speed data transfer capabilities, offering up to **2.5 Gbps for downloads** and **650 Mbps for uploads**, this router is an ideal solution for demanding IoT applications, including industrial routers and gateways, digital signage, industrial computers, and tablets, among others.

The router, enclosed in a robust metal chassis, is equipped with five **1Gb Ethernet ports**, one **SFP cage**, along with interfaces for **RS232**, **RS485**, and **CAN bus**. It also offers two **digital inputs** and two **digital outputs**.

For maximal performance on the cellular network, the router utilizes **4x4 MIMO** technology. An antenna for **GNSS** can be connected to the router.

The ICR-4453 is positioned as a **LTE Advanced Cat 12** router and a powerful edge computing gateway, tailored for the global market.

Featuring high-speed data transfer rates of up to **600 Mbps for downloads** and **150 Mbps for uploads**, this router is perfectly suited for demanding IoT applications in various industries, including industrial routers and gateways, digital signage, and industrial PCs and tablets.

Two antennas, the primary **ANT** and the diversity **DIV**, are designated for cellular network connectivity. Additionally, an antenna for **GNSS** can be connected to the router. Models equipped with WiFi offer **WiFi** functionality, utilizing **3x3 MIMO** antennas for enhanced wireless performance.

Housed within a robust metal enclosure, the router features two **SIM card slots** for cellular connection redundancy. It is also outfitted with five **1Gb Ethernet ports** and an **SFP cage**, plus interfaces for **RS232**, **RS485**, and **CAN bus**. Furthermore, it provides two **digital inputs** and two **digital outputs** for comprehensive connectivity and control options. A **microSD card** slot is included to enhance storage options.

Housed within a robust metal enclosure, the router is equipped with two **SIM card slots** to ensure cellular connection redundancy. It also boasts two **1Gb Ethernet ports**, a **USB 3.0** socket, dual switchable **RS232/RS485** interfaces, four **digital inputs**, and two **digital outputs** for comprehensive connectivity and control options. Additionally, a **microSD card** slot is available to expand storage capabilities.

The router features a **Low Power Mode** and a **hardware watchdog** for automated status monitoring and system restarts, supplemented by additional diagnostic functionalities to bolster overall reliability.

Router configuration is accessible through a **secure web interface**, offering detailed insights into the entire configuration, statuses, signal strength, and logs.

Basic features include **two-factor authentication**, **IPv6 Dual Stack**, **DHCP**, **NAT**, **NAT-T**, **DynDNS**, **DNS proxy**, **VLAN**, **QoS**, **NTP**, **VRRP**, **SMS control**, **port forwarding**, and **connection backup**, among others. The router supports various VPN protocols, including **IPSec**, **OpenVPN**, **GRE**, **L2TP**, and **PPTP**, ensuring secure communication.

The router allows for the insertion of **Linux scripts** for automated tasks. It supports the definition of up to **four distinct profiles**, switchable via the web interface, SMS, or digital input.

**Router Apps** enhance router functionality through custom software programs. For Advantech routers, a diverse array of Router Apps is offered, encompassing categories such as connectivity, routing, services, among others, freely accessible on the Advantech [Router Apps](#) webpage. Additionally, directly from the router web interface, you can use an **Advantech public server** for the Router App or router firmware installation/update.

Compatibility with Advantech's **remote device management** platform, [WebAccess/DMP](#), offers extensive device management and monitoring, ensuring that devices remain up-to-date and secure.



## 1.2 Hardware Overview

In this chapter, all components of the router case are described, including links to chapters that provide more details.

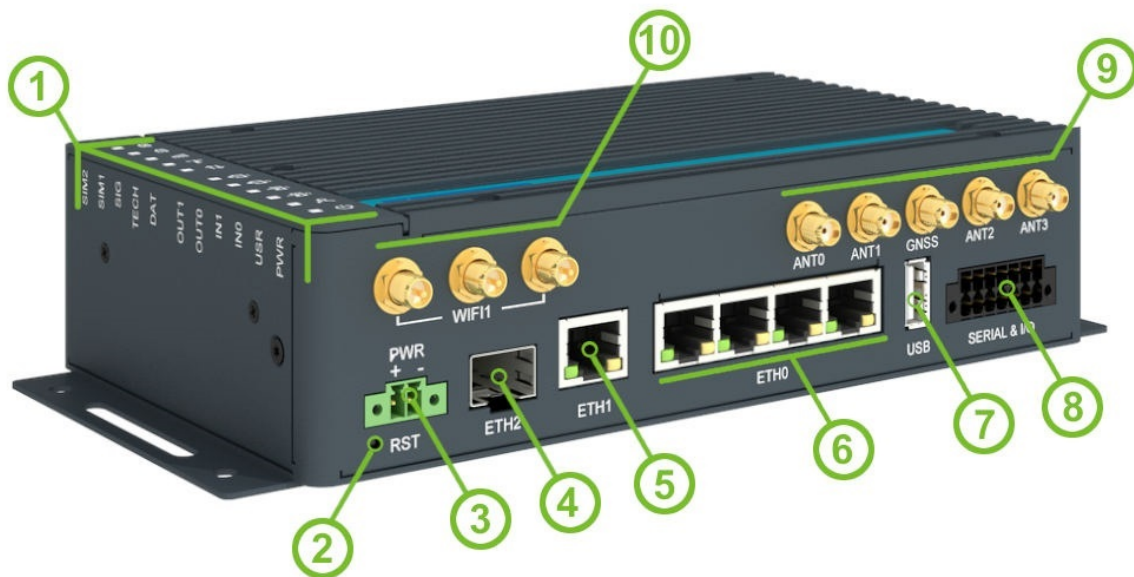

Figure 1: Router Hardware Overview – Front View

#	Item/Caption	Type	Description
1	LEDs	—	Status LED indication; see Chapter 2.12.
2	RST	—	Button to reboot the router or to restore the default configuration; see Chapter 2.13.
3	PWR	2-p term.	Power supply socket; see Chapter 2.6.
4	ETH2	SFP cage	SFP cage socket see Chapter 2.5.
5	ETH1	RJ45	1 Gb Ethernet for the second LAN; see Chapter 2.3.
6	ETH0	RJ45	1 Gb Ethernet switched connection (with four ports) for the first LAN; see Chapter 2.3.
7	USB	USB-A	USB 2.0 host port; see Chapter 2.10.
8	SERIAL & I/O	14-pin terminal	RS232, RS485, CAN bus, digital input, and digital output interfaces. See Chapter 2.8 for more information, Chapter 3.7 for I/O parameters, and Chapter 3.8 for serial interface parameters.
9	ANT0, ANT1, GNSS, ANT2, ANT3	SMA female	Cellular module and GNSS antenna connectors. See Chapter 2.2 for more information, Chapter 3.4 for cellular module parameters, Table 21 for module antenna mapping and Chapter 3.5 for GNSS parameters.
10	WIFI1	RP-SMA female	Connectors for the WiFi antennas. See Chapter 2.2 for more information and Chapter 3.6 for WiFi parameters.

Table 1: Router Hardware Overview – Front View



Figure 2: Router Hardware Overview – Rear View

#	Item/Caption	Type	Description
11	Grounding screw	M3	Pay attention to proper grounding; see Chapter 2.6.
12	SIM slots microSD slot	Mini SIM microSD	Two Mini SIM card slots; see Chapter 2.1 for more information and Chapter 3.4 for cellular module parameters. MicroSD card slot; see Chapter 2.11.
13	Wall clips	—	Wall mounting clips, included as standard accessories; see Chapter 1.8.

Table 2: Router Hardware Overview – Rear View

## 1.3 Order Codes

Order codes overview is shown in the table below.

Order code	Configuration
ICR-4453	5G NR cellular module, Gb ETH SWITCH, GNSS, SFP cage, USB, microSD card slot, RS232, RS485, CAN bus, two digital inputs, two digital outputs, two SIM readers
ICR-4453S	5G NR cellular module, Gb ETH SWITCH, GNSS, SFP cage, <b>PoE PSE</b> , USB, microSD card slot, RS232, RS485, CAN bus, two digital inputs, two digital outputs, two SIM readers
ICR-4453W	5G NR cellular module, Gb ETH SWITCH, GNSS, SFP cage, <b>dual-band WiFi</b> , USB, microSD card slot, RS232, RS485, CAN bus, two digital inputs, two digital outputs, two SIM readers
ICR-4453WS	5G NR cellular module, Gb ETH SWITCH, GNSS, SFP cage, <b>PoE PSE</b> , <b>dual-band WiFi</b> , USB, microSD card slot, RS232, RS485, CAN bus, two digital inputs, two digital outputs, two SIM readers
ICR-4453W1 <sup>1</sup>	5G NR cellular module, Gb ETH SWITCH, GNSS, SFP cage, <b>dual-band WiFi</b> , USB, microSD card slot, RS232, RS485, CAN bus, two digital inputs, two digital outputs, two SIM readers
ICR-4453W1S <sup>1</sup>	5G NR cellular module, Gb ETH SWITCH, GNSS, SFP cage, <b>PoE PSE</b> , <b>dual-band WiFi</b> , USB, microSD card slot, RS232, RS485, CAN bus, two digital inputs, two digital outputs, two SIM readers

Table 3: Order Codes Overview

## 1.4 Product Revisions

For the product revision history of the entire product platform, refer to the table below. Please note that some revisions may not be available for certain order codes. The revision number is printed on both the packaging and product labels.

The router GUI can also display the product revision under *Status* → *General* → *System Information* → *Product Revision*. Please note that the default revision (Rev. 1.0) may not be available here.

Rev.#	Description
1.0	Initial version (revision number not printed on the labels).
2.0	New design of the mainboard and PoE board; see <a href="#">PCN-2023-03</a> for details.

Table 4: HW Revisions History

<sup>1</sup>This product has no E8 certification and has a limited operating temperature range of -40 °C to +60 °C.

## 1.5 Package Contents

The standard set of router includes items listed in the following table:





Item#	Description	Figure	Q'ty
1	Router		1 pcs
2	Wall clips for wall mounting (screwed on the router)		2 pcs
3	2-pin terminal block for power supply (deployed on the router)		1 pcs
4	14-pin terminal block for RS232, RS485, CAN BUS, and I/O (deployed on the router)		1 pcs
5	Printed <i>Quick Start Guide Leaflet</i>		1 pcs

Table 5: Contents of Package

### 1.6 Product Dimensions

For the dimensions of the router see the figures below. Note that all sizes are measured in millimeters.

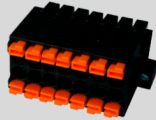
#### Variant with Wall Mounting Clip

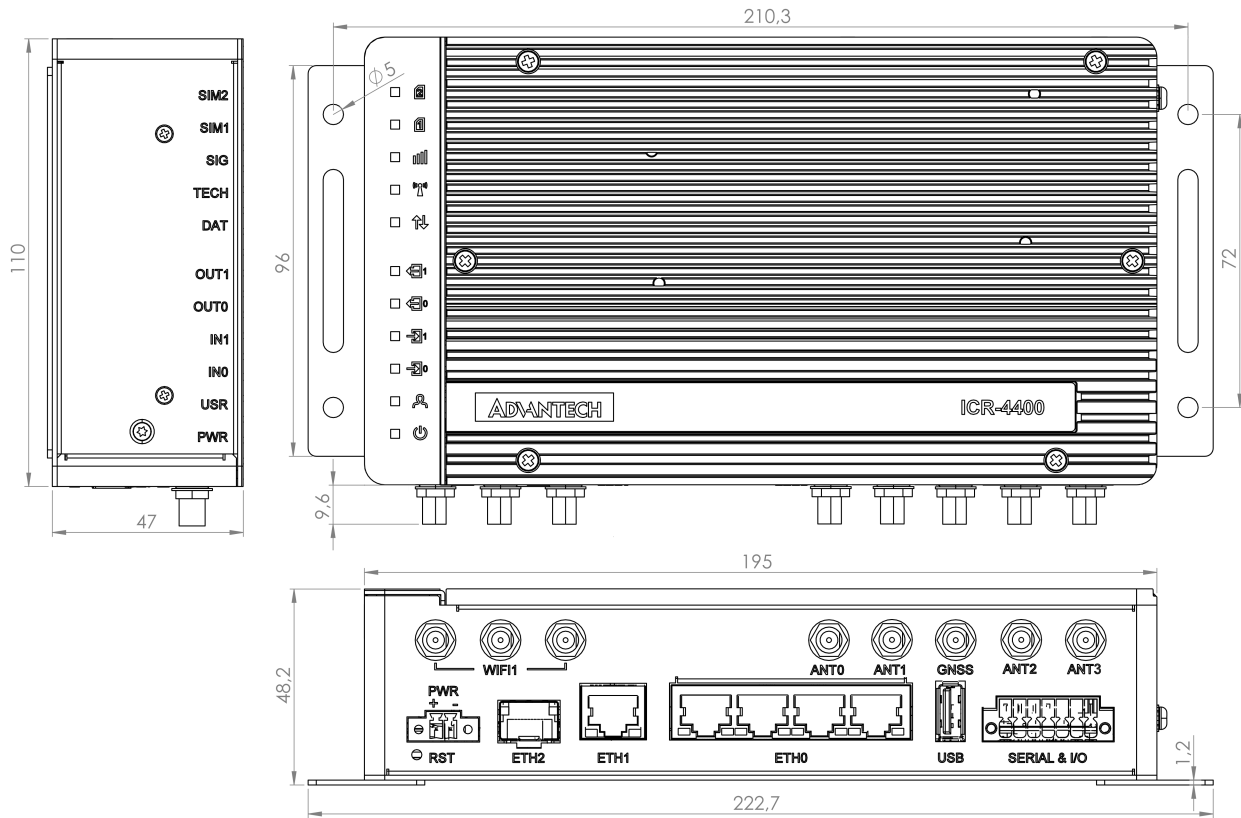

Figure 3: Router Dimensions – Front, Top and Right view with Wall Mounting holder

### Variant with DIN Rail Clip

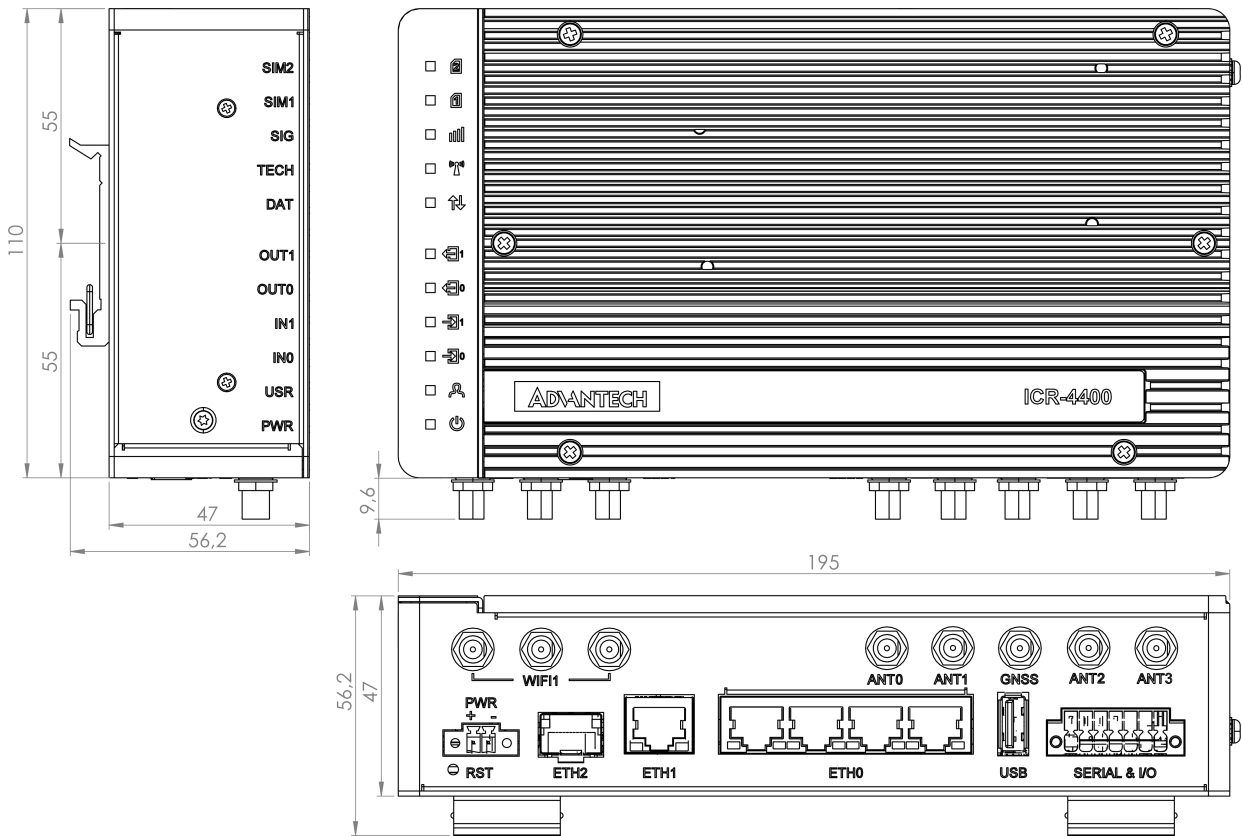

Figure 4: Router Dimensions – Front, Top and Right view with DIN holder

## 1.7 Mounting Recommendations

The router can be placed in the following ways:

- On a flat surface.
- On a wall using the wall mounting clip (refer to Chapter 1.8).
- On a DIN rail EN 60715 with the metal DIN rail clip (refer to Chapter 1.9).

For most applications involving a built-in router within a switchboard, two types of environments are typically encountered:

- A non-public industrial environment with low voltage but high interference.
- A public environment with low voltage and without high interference.

For both of these environments, it's feasible to mount the router to a switchboard, eliminating the need for immunity examination or EMC-related issues as per EN 61439-1:2011 standards.



To comply with the EN 61439-1:2011 specification, follow these assembly instructions when attaching a router to a switchboard:

- When using whip antennas, maintain a minimum distance of 6 cm from cables and metal surfaces on all sides to avoid interference. If an external antenna is used apart from the switchboard, a lightning conductor is necessary.
- When mounting a router on sheet steel, consider using a cable antenna.

For all cables, it's recommended to bundle them, following these guidelines:

- The combined length of the cable bundle (power supply and data cables) should not exceed 1.5 m. If data cable length surpasses 1.5 m or if the cable runs toward the switchboard, installing surge protectors is advisable.
- Data cables must not be bundled with mains voltage cables (230 V/50 Hz or 120 V/60 Hz).
- Ensure sufficient space is left between each connector for cable handling.
- For proper router functionality, use an earth-bonding distribution frame to ground the grounding screw (refer to Chapter 2.6).

## 1.8 Wall Mounting

**i** The wall mounting clip is included as a standard accessory with the router.

The router can be affixed to a wall or another surface using the wall mounting clips. Two wall mounting clips are pre-assembled to the router during production and need to be rotated as shown in Figure 5.

Each clip features two holes with a diameter of 5 millimeters for screw placement. For precise mounting dimensions, refer to Figure 3 in Chapter 1.6.

**!** When attaching the wall mounting clip, tighten the screws with a maximum torque of 0.4 Nm.

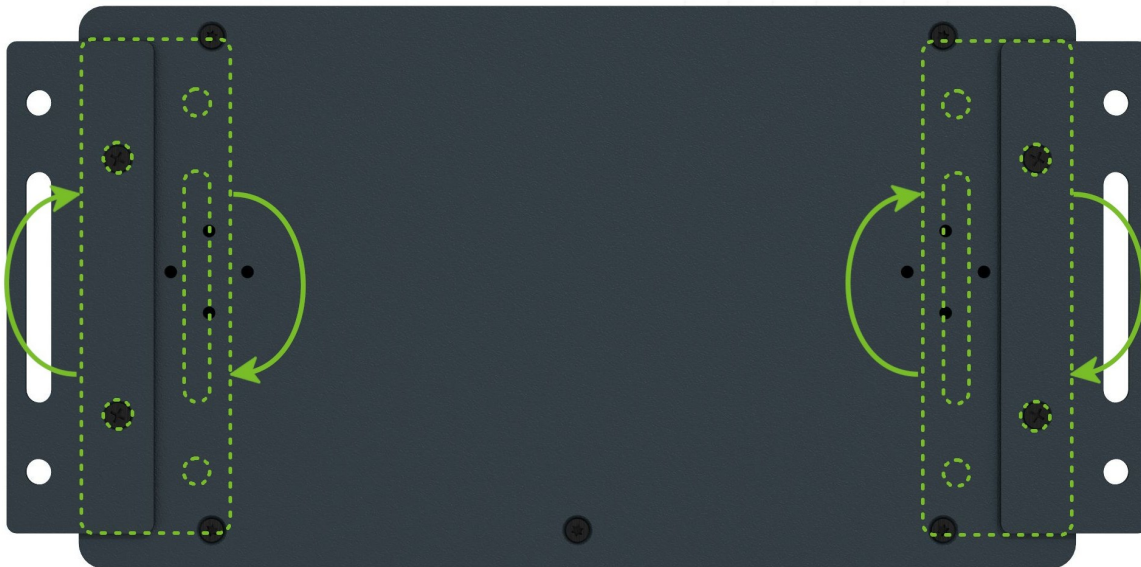

Figure 5: Rotated Wall Mounting Clips



## 1.9 DIN Rail Mounting

**i** The DIN rail clips are not included as standard accessories with the router. However, they can be ordered using the order code *BB-DIN-ICR32* (two pieces for one router).

You can attach two DIN rail clips to the router for mounting it onto a DIN rail that complies with the 60715 standards. The default position of the clips is depicted in Figure 6. If necessary, the clips can also be rotated vertically.

**!** When attaching the clips, tighten the screws with a maximum torque of 0.4 Nm.



Figure 6: Default Position of the DIN Rail Clips

To remove the router from the DIN rail, lightly push down on the router to disengage the bottom part of the DIN rail clip from the rail. Then, pivot the bottom part of the router away from the DIN rail, as demonstrated in Figure 7.

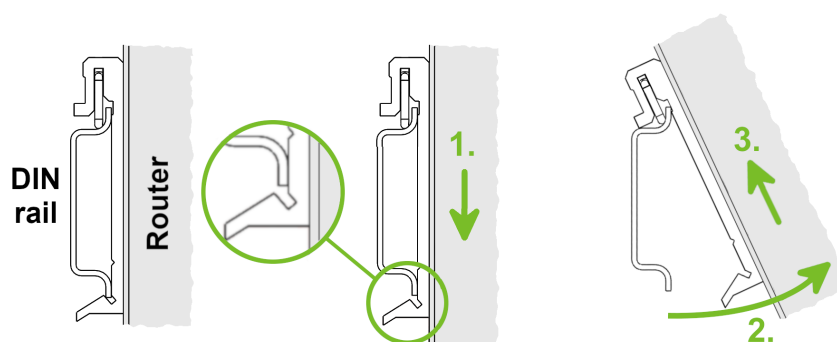

Figure 7: Removing Router from the DIN Rail

### 1.10 Product Label

The figure below shows an example of the product labels with all the information printed on them.

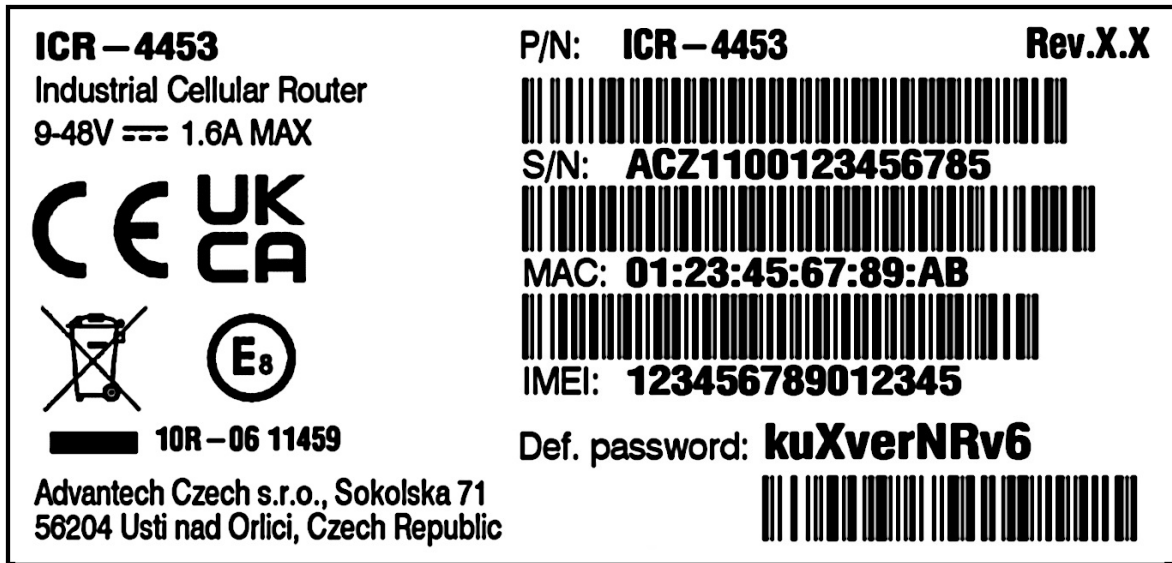



Figure 8: Product Label

## 1.11 First Use

You can perform the initial configuration of the router using a web browser on your PC. This interface enables router monitoring, configuration, and administration.

- 
- Before putting the router into operation, ensure that all components required for running your applications are connected. Refer to Chapter [1.2 Hardware Overview](#) for an overview of the hardware.
  - Do not operate the router without an antenna connected to the main antenna connector. Transmitted energy will be reflected by an open connector, which could potentially damage the equipment.

The procedure for connecting to a new router is described in the *Configuration Manual* [1], Chapter *Introduction* → *Configuration Environments* → *Initial Web Configuration GUI Access*. This manual also provides detailed descriptions and examples of router configuration using the web interface.

# 2. Hardware Functionality

See Chapter 1.2 for an overview of the product's hardware, along with links to chapters offering detailed explanations.

## 2.1 SIM Card Slots

Slots for two SIM cards are located on the router beneath a metal cover. If you plan to use this device for cellular network communication, insert an activated data-provisioned SIM card into the SIM card slot.

You have the option to install two SIM cards simultaneously for utilizing the switching feature. The SIM cards can have different Access Point Names (APNs) configured. The procedure for changing SIM cards is outlined below. If the SIM requires a PIN, input it in the router's web interface (*Administration* → *Unlock SIM Card*).

 Type of SIM card: Mini SIM (2FF) 25.0 × 15.0 × 0.76 mm.

### Inserting the SIM card:

- Always disconnect the router from the power supply before handling the SIM card.
- Unscrew the two screws on the SIM card cover and remove the cover.
- To remove an inserted SIM card, use the flat end of a spudger or your fingernail to press the SIM card slightly into its slot until you hear a click. Upon hearing the click, release the card, and it will pop out of its slot.
- To insert a SIM card, push the card into the slot until it clicks into place.
- Put the cover back and secure it with the two screws.

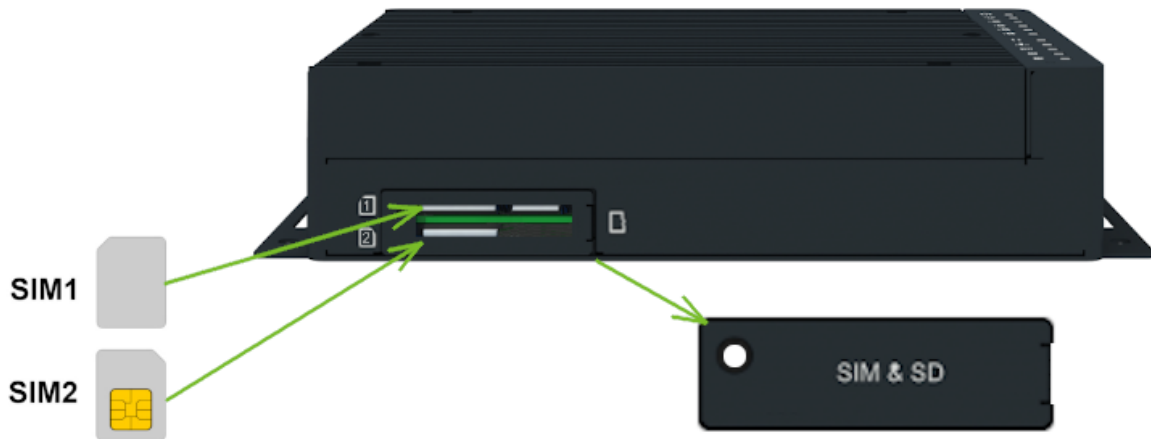

Figure 9: SIM Cards Insertion

## 2.2 Antennas Interfaces

SMA female connectors (*ANT0*, *ANT1*, *ANT2*, and *ANT3*) are intended for connecting cellular antennas to the router. See Table 21 for module antenna mapping. The GNSS antennas can be connected to the *GNSS*. In addition, RP-SMA female connectors *WiFi1* are available for the connecting the WiFi antennas.

**!** Do not run the router without connected cellular antennas as the energy from the transmission is effectively reflected by the open end and can damage the equipment.

**i** Recommended tightening moment for screwing the antenna to the SMA connector is 0.9 Nm.

## 2.3 Ethernet Interfaces

The RJ45 panel socket is used for four ETH0 (switched) and one ETH1 Ethernet interfaces. The pinout of the socket is shown in Figure 12 and described in Table 6.

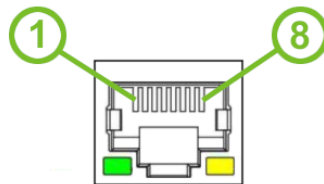

Figure 10: Ethernet Connector Pinout of RJ45 Socket



Pin	10base-T & 100base-T	1000base-T	PoE PSE (Mode B)
1	Tx+ (Transmit Data+)	BI_DA+ (BiDirectional pair A+)	—
2	Tx- (Transmit Data-)	BI_DA- (BiDirectional pair A-)	—
3	Rx+ (Receive Data+)	BI_DB+ (BiDirectional pair B+)	—
4	—	BI_DC+ (BiDirectional pair C+)	PoE PSE+ (positive pole)
5	—	BI_DC- (BiDirectional pair C-)	PoE PSE+ (positive pole)
6	Rx- (Receive Data-)	BI_DB- (BiDirectional pair B-)	—
7	—	BI_DD+ (BiDirectional pair D+)	PoE PSE- (negative pole)
8	—	BI_DD- (BiDirectional pair D-)	PoE PSE- (negative pole)

Table 6: Ethernet Connector Pinout Description of RJ45 Socket

**i** All four ETH0 ports can be used for **PoE PSE** if the router is equipped with this feature. For more information about the PoE, see Chapter 2.4; for technical parameters, see Chapter 3.9.

**i** The isolation barrier of the Ethernet ports against the ground is 1500 V.

## 2.4 Power over Ethernet (PoE) PSE

-  Available only for models with the PoE PSE feature; see Chapter 1.3 for the order codes.
-  The router supports the *IEEE 802.3af/PoE* (Type 1) and *IEEE 802.3at/PoE+* (Type 2) standards and is Mode B compliant.
-  To control the PoE functionality, you can use the `pse` command. For detailed information, please refer to the *Command Line Interface* application note.



Please note that the router's power supply must be 48 V DC to operate as the PoE PSE device.

The PoE PSE feature enables the router to provide power to other devices over the Ethernet socket. You can refer to the functional scheme in Figure 11.

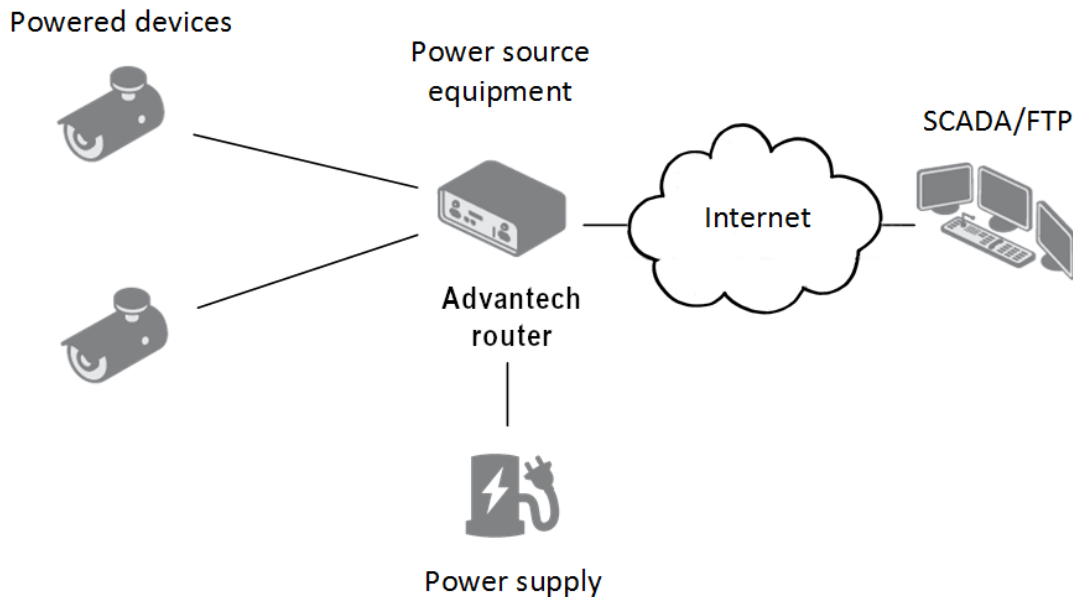

Figure 11: PoE PSE Funcional Scheme

The PoE PSE feature is supported by all four ETH0 network sockets and can be individually enabled in the *Ethernet* configuration pages. Detailed instructions can be found in the router configuration manual [1], specifically in Chapter *Configuration* → *Ethernet Configuration*. For information about the Ethernet socket pinout, please refer to Chapter 2.3.

To monitor the current PoE state, navigate to the *General* status page in the GUI. When PoE is enabled and an external device is being powered, you can access information about current, voltage, power, and power class here.

The following table summarizes the PoE parameters.

PoE PSE parameters	
Required power supply parameters	48 V / up to 135 W
Power available to a PoE device	12.95 W / per port
Required power supply wattage for a PoE device	15.40 W / per port
Power available to a PoE(+) device	25.50 W / per port
Required power supply wattage for a PoE(+) device	30.0 W / per port

Table 7: PoE PSE Parameters

## PoE Power Budget Examples

### Example #1

This example is for the Advantech [RPS-ICR4-WR2-PSE](#) power supply, which can supply a power of **65 W**. We will use 15 W as the maximum router power consumption; see Chapter [efchap:BasicParams](#). You can use this power supply to power:

- up to **three PoE devices** ( $3 \times 15.4 \text{ W} + 15 \text{ W} = 61.2 \text{ W} < 65 \text{ W}$ ),
- just **one PoE+ device** ( $1 \times 30 \text{ W} + 15 \text{ W} = 45 \text{ W} < 65 \text{ W}$ ).

### Example #2

To power four PoE+ devices, you should use a power supply with a minimum rating of 135 W. You can calculate this as follows:

- Required power supply wattage =  $4 \times 30 \text{ W} + 15 \text{ W} = 135 \text{ W}$ .



Ensure that the power supply you use can provide enough power to cover the required power consumption of all connected PoE devices, including the router itself. We recommend using a power supply with some power reserve.

## 2.5 SFP Cage

A hot-pluggable (SFP) network interface module with a speed of up to 10 Gbps can be settled into the ETH2 SFP cage.

### Installing an SFP Module

To install an SFP module, please refer to Figure 12 and follow these steps:

- If the SFP module is equipped with a bale clasp, ensure it is closed before inserting the SFP module.
- Hold the SFP module with the hardware label facing up.
- Gently insert the SFP module into the ETH2 slot and push it until it securely snaps into place.



Figure 12: SFP Module Installation

See Table 8 for a list of successfully tested SFP modules on the product.

Model	Manufacturer
<a href="#">SFP-GSM-20K</a>	Advantech
ML-S+31Dout-10	MaxLink
S-3553LC20D	MikroTik
SFP-PLUS-LR10-HPE	Hewlett Packard
SFP-TXCIS	OEM
TXM431-LR(UN)	TP-Link
UF-RJ45-1G	Ubiquiti

Table 8: Tested SFP Modules



## 2.6 Power Supply

A two-pin terminal connector (pitch 3.5 mm) is utilized to power the router. The corresponding connector is included as a standard accessory with the router.

Pin	Signal mark	Description
1	VCC(+)	Positive pole of DC supply voltage (+9 to +48 V DC)
2	GND(-)	Negative pole of DC supply voltage

Table 9: Power connector pinout

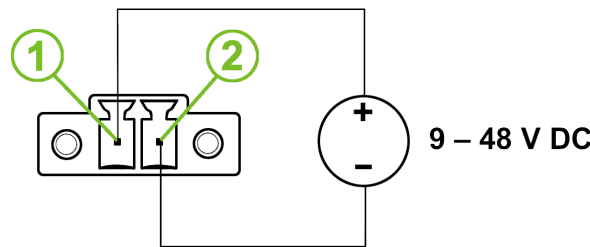

Figure 13: Power Connector Pinout

The required power supply voltage for the router ranges between +9 V and +48 V DC. Refer to the connection scheme in Figure 13 for proper setup. The router is equipped with built-in protection against reversed polarity, functioning without signaling. To guarantee correct operation, the power source must be capable of providing a sufficient amount of energy, as detailed in the consumption section of Chapter 3.1.



Grounding the router using the grounding screw eliminates the protection against reversed polarity. Ensure the negative pole of the DC power supply shares the same voltage reference as the grounding screw. A voltage difference between these points may damage the router, necessitating repairs exclusively by an authorized service center.



The power voltage for the PoE router version must be 48 V DC for it to function as a PoE PSE device.

All metal parts, including the box, are interconnected with the negative pole of the power supply (common pole). If recommended for the installation environment, protect the router by properly grounding it using the grounding screw, as depicted in Figure 14. The maximum tightening torque for the grounding screw is 1 Nm.



Figure 14: Position of the Grounding Screw

## 2.7 Low Power Mode



In applications requiring low power consumption, such as solar power (not 24/7 mode), it is strongly recommended to use the Low Power Mode (LPM) before shutting down the entire router.

LPM (Low Power Mode) is a router mode in which the router enters a sleep state with minimal power consumption; you can find details about LPM power consumption in Chapter [efchap:BasicParams](#). The router can be awakened from this mode either by applying a signal to the BIN1 input or after a predefined period of time. To put the router into LPM mode, you can use the `lpm` command; for more information, refer to the [Command Line Interface](#) application note.

## 2.8 I/O Port Interfaces

The I/O user interface is designed for digital input processing and digital output control. The pinout of the I/O interface is described in Figure 15 and Table 10. For detailed electrical parameters see Chapter 3.7. The functional scheme of connection for the digital input and digital output is in Figure 16.

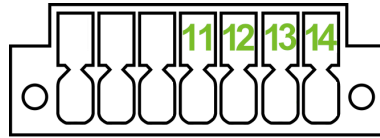

Figure 15: I/O Connector Pinout

Pin	Signal mark	Description
11	BIN0	The first digital input
12	BOUT0	The first digital output
13	BIN1	The second digital input
14	BOUT1	The second digital output

Table 10: Connection of I/O Ports

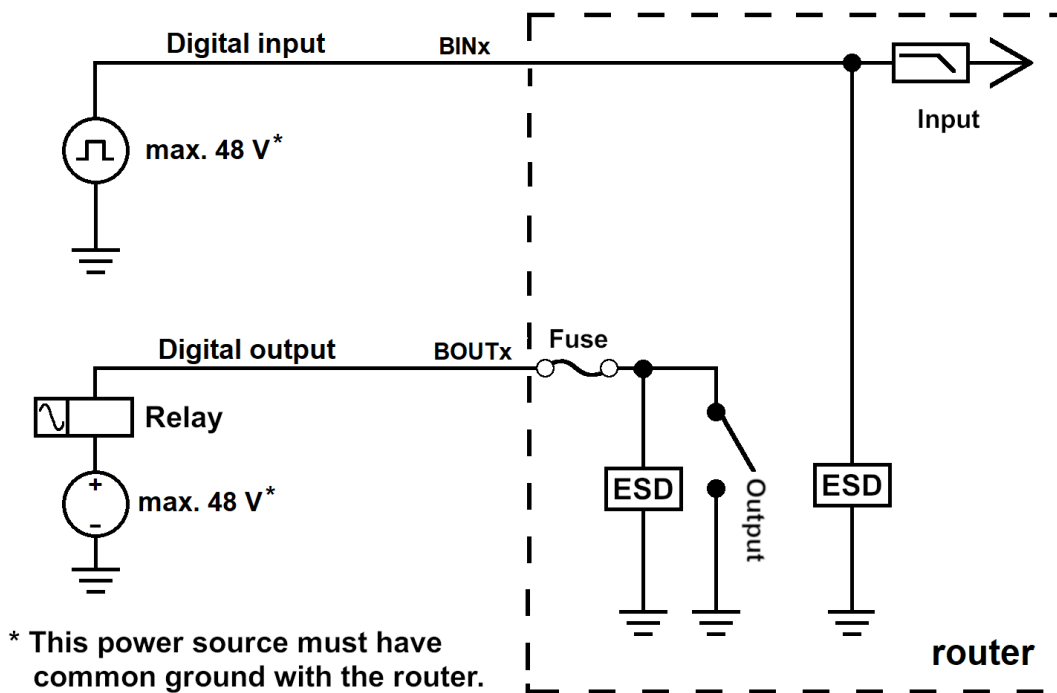

Figure 16: Functional Scheme of the Digital Interface

## 2.9 Serial Interfaces

The RS232, RS485 CAN serial interfaces together with the two I/O interfaces are physically connected to the 14-pin terminal block panel socket. All these interfaces are not isolated from the router. The pinout of this connector is described in Figure 17 and the tables below.

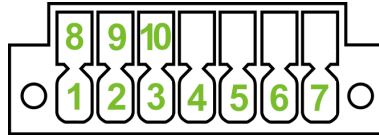

Figure 17: Serial Connector Pinout

Pin	Signal mark	Description
1	RXD	Received Data
2	CTS	Clear to Send
3	GND	Ground
4	RTS	Request to Send
5	TXD	Transmit Data

Table 11: Connection of RS232

Pin	Signal mark	Description
6	CAN_H	CAN High
7	CAN_L	CAN Low

Table 12: Connection of CAN Bus

Pin	Signal mark	Description
8	B (+)	In/Out
9	A (-)	In/Out
10	GND	Ground

Table 13: Connection of RS485

## 2.10 USB Port

The router is equipped with a single USB 2.0 host port featuring a USB-A type socket. The pinout details of the USB socket are illustrated in Figure 18 and further described in Table 14.

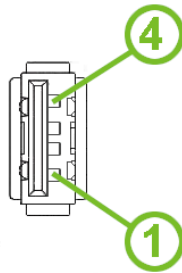

Figure 18: USB Connector Pinout

Pin	Signal Mark	Description	Data Flow Direction
1	+5 V	Positive pole of 5 V DC supply voltage, 0.5 A	
2	USB Data -	USB data signal (negative pole)	Input/Output
3	USB Data +	USB data signal (positive pole)	Input/Output
4	GND	Negative pole of DC supply voltage	

Table 14: USB Connector Pinout

For detailed USB port configuration options, refer to the configuration manual [1], Chapter *Configuration* → *USB Port*.

## 2.11 MicroSD Card Reader

The microSD card reader is located under the SIM cover on the router. This card reader enables the router to utilize microSD memory cards. The technical specifications are presented in Table 15.

Technical specifications of microSD card		
Supported technologies	SD, SDHC, SDXC	
Supported capacity	SDHC SDXC	up to 32 GB from 32 GB to 512 GB
Supported microSD card filesystems	vfat, ext2, ext3, ext4	

Table 15: Technical Specifications of MicroSD Card

### Inserting the microSD card:

- To remove an inserted microSD card, use the flat end of a spudger, or your fingernail, and press the card slightly into its slot until you hear a click. Release the card, and it will pop out of its slot.
- To insert a microSD card, push the card into the slot with the correct orientation as shown in the picture until it clicks into place.

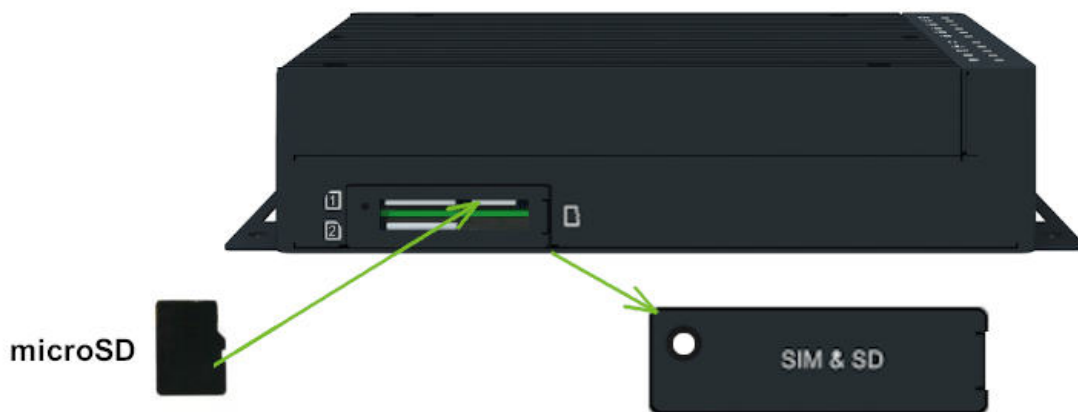

Figure 19: MicroSD Card Insertion

### Mounting microSD Card to the System

To access the microSD card within the router's system, it must be mounted. Follow these steps to mount the card:

- Use the `dmesg` command to view the list of recently connected devices.
- Identify the entry for the microSD card in the command's output, for example:  
`mmcblk0: p1`
- To mount the card to the `mnt` directory, use the `mount` command:  
`mount /dev/mmcblk0p1 /mnt`



For more information about the commands for creating, mounting, checking, and unmounting a file system on a microSD card, refer to the application note for the [Ext4 Filesystem Utilities](#) router app.

## 2.12 LED Status Indication

There are status LEDs on the top side of the router to provide router status information. Moreover, ETH0 and ETH1 connectors, located on the front panel, have two additional LEDs providing information about the port status.













	Caption	Color	State	Description
	PWR	Green Green Green	On Blinking Fast blinking	The router is booting up. The router booted up and is ready. The router firmware is being updated.
	USR	Green	—	The function of this LED is user-defined.
	IN0	Green	On	The first digital input is active.
	IN1	Green	On	The second digital input is active.
	OUT0	Green	On	The first digital output is active.
	OUT1	Green	On	The second digital output is active.
	DAT	Green	Blinking	Cellular communication is in progress.
	SIG	Green Orange Red	On On On	Good cellular signal. Fair cellular signal. Poor cellular signal.
	TECH	Green Orange Red	On On On	The active SIM uses 5G technology. The active SIM uses 4G technology. The active SIM uses 3G technology.
	SIM1	Green Red	On Fast blinking	SIM1 is active for the cellular connection. A SIM1 issue (missing card or PIN not entered).
	SIM2	Green Red	On Fast blinking	SIM2 is active for the cellular connection. A SIM2 issue (missing card or PIN not entered).
	ETH0 ETH1	Green Green	On Off	Selected 1 Gbps bit rate. Selected 100/10 Mbps bit rate.
	ETH0 ETH1	Yellow Yellow Yellow	On Brief off blinks Off	The network cable is connected. Data transmission. The network cable is not connected.

Table 16: LED Status Indication

## 2.13 Reset Functions

The *RST* button has multiple functions. For more details, refer to the configuration manual [1], Chapter *Introduction* → *Device* → *Reset*.

-  Use a narrow screwdriver or a small tool to press the *RST* button.



Figure 20: Resetting the Router



# 3. Technical Parameters

## 3.1 Basic Parameters

Parameter		Description
Temperature range	Operating Storage	-40 °C to +75 °C (-40 °F to +167 °F) <sup>1</sup> -40 °C to +85 °C (-40 °F to +185 °F)
Humidity	Operating Storage	5 to 95 % relative humidity non condensing 5 to 95 % relative humidity non condensing
Altitude	Operating	2000 m / 70 kPa
Degree of protection		IP30
Supply voltage		9 – 48 V DC
Battery for RTC		CR1225
Consumption for non-WiFi / WiFi version	Idle Average Maximum LPM mode	5.9 W / 6.8 W 6.7 W / 8.8 W 11.3 W / 16.0 W (142 W) <sup>2</sup> 3 mW (170 mW) <sup>3</sup>
Dimensions of device (w/o clips)		195 × 110 × 47 mm (7.68" × 4.33" × 1.85")
DIN rail clip specification		2 pcs of DIN 35 mm, EN 60715
Total weight		1275 g (2.81 lbs)

Table 17: Basic Parameters

<sup>1</sup>Models having ICR-4453W1x order codes have an operating temperature range of -40 °C to +60 °C.

<sup>2</sup>Maximal power consumption for model with the PoE PSE (for maximal power load on all ETH0 ports).

<sup>3</sup>For device equipped with the PoE PSE.

## 3.2 Standards and Regulations

Parameter	Description
Radio	EN 301 908-1, EN 301 908-2, EN 301 908-13, EN 301 908-25, EN 303 413, EN 301 893, EN 300 328
EMC	EN 301 489-1, EN 301 489-17, EN 301 489-19, EN 301 489-52, EN 61000-4-2, EN 61000-4-3, EN 61000-4-4, EN 61000-4-5, EN 61000-4-6, EN 61000-6-2, EN 55032
Safety	EN 62368-1, IEEE 802.3, EN IEC 62311
Mechanical	EN 60068-2-27, EN 60068-2-64, EN 60529
Climatic	EN 60068-2-2, EN 60068-2-1, EN 60068-2-14, EN 60068-2-30
Transportation	E-Mark (E8), homologation number: 10R - 06 11459 <sup>1</sup>
National	CE, UKCA compliant
Environmental	REACH, RoHS3 and WEEE compliant

Table 18: Standards and Regulations

<sup>1</sup>Models having ICR-4453W1x order codes have no E8 certification.

### 3.3 Type Tests and Environmental Conditions

Phenomena	Test	Description	Test levels
ESD	EN 61000-4-2	Enclosure contact	± 6 kV (crit. A)
RF field AM modulated	EN 61000-4-3	Enclosure	20 V/m (crit. A) (80 – 1000 MHz) 10 V/m (crit. A) (1 – 6 GHz)
Fast transient	EN 61000-4-4	Signal ports Power ports Ethernet ports	± 1 kV (crit. A) ± 2 kV (crit. A) ± 1 kV (crit. A)
Surge	EN 61000-4-5	Ethernet ports Power ports	± 1 kV (crit. A), shielded cab. ± 1 kV (crit. A)
RF conducted	EN 61000-4-6	All ports	10 V/m (crit. A) (0.15 – 80 MHz)
Radiated emission	EN 55032	Enclosure	Class B
Conducted emission	EN 55032	Signal ports Power ports Ethernet ports	Class B Class B Class B
Dry heat	EN 60068-2-2	Test Bb, storage +85 °C, operation +75 °C	
Cold	EN 60068-2-1	Test Ab, storage -40 °C, operation -40 °C	
Damp heat	EN 60068-2-78	95 % rel. humidity (+40 °C)	
Dry heat, cyclic	EN 60068-2-30	+55 °C / +25 °C, rel. humidity 95 %, 6 h - 6 h	
Dry heat	EN 60068-2-2	Test Bb, storage +85 °C, operation +75 °C	
Thermal shock/ temp. variation	EN 60068-2-14	Test Nb, -40 °C/+75 °C, 3h/3h, 2 cycles, 3 K/min	
Degrees of protection provided by enclosures	EN 60529	IP30	
Vibration, broadband random	EN 60068-2-64	Spectrum A.3 cat 1, breakpoints A.6 cat 1	
Shock	EN 60068-2-27	50 m/s <sup>2</sup> , 11 ms, half sine, 10 in each dir.	

Table 19: Type Tests and Environmental Conditions

### 3.4 Parameters of Cellular Module

Parameter	Description
Antenna	<ul style="list-style-type: none"> <li>• Impedance: 50 <math>\Omega</math></li> <li>• Connector type: SMA (4 pcs)</li> </ul>
5G NR parameters	<ul style="list-style-type: none"> <li>• 3GPP Rel-15 support</li> <li>• Supported modulations: <math>\pi/2</math>-BPSK, QPSK, 16QAM, 64QAM and 256QAM modulation for uplink; QPSK, 16QAM, 64QAM and 256QAM for downlink</li> <li>• 2 x 2 MIMO<sup>1</sup> uplink support for n41</li> <li>• 4 x 4 MIMO downlink for n1, n2, n3, n7, n25, n38, n40, n41, n48, n66, n77, n78, n79</li> <li>• Supporting SCS 15 kHz<sup>2</sup> and 30 kHz<sup>2</sup></li> <li>• SA<sup>3</sup> and NSA<sup>3</sup> operation modes on all the 5G bands</li> <li>• Option 3x, 3a, and Option 2</li> <li>• Supported bands: n71 (600 MHz), n12 &amp; n28 (700 MHz), n20 (EU800 800 MHz), n5 (850 MHz), n8 (900 MHz), n66 (Extended AWS 1700 MHz), n3 (1800 MHz), n2 (1900 MHz), n25 (Extended PCS 1900 MHz), n1 (2100 MHz), n40 (S-Band 2300 MHz), n41 (2500 MHz), n7 &amp; n38 (2600 MHz), n48 &amp; n78 (3500 MHz), n77 (3700 MHz), n79 (4700 MHz)</li> <li>• NSA TDD: max. 2.5 Gbps(DL), max. 650 Mbps (UL)</li> <li>• SA TDD: max. 2.1 Gbps(DL), max. 450 Mbps (UL)</li> <li>• Max. output power: 26 dBm +2/-3 dB (Class 2)</li> </ul>

Continued on next page

<sup>1</sup>Uplink 2 x 2 MIMO is only supported in 5G SA mode.

<sup>2</sup>5G NR FDD bands only support 15 kHz SCS, and NR TDD bands only support 30 kHz SCS.

<sup>3</sup>Supported bandwidth in the NSA and SA modes may differ for each frequency band.

Continued from previous page

Parameter	Description
LTE parameters	<ul style="list-style-type: none"> <li>• 3GPP Rel-15 support (DL Cat 16 / UL Cat 18)</li> <li>• Supported modulations: QPSK, 16QAM, 64QAM and 256QAM (uplink/downlink)</li> <li>• 4 x 4 MIMO downlink for B1, B2, B3, B4, B7, B25, B30, B38, B39, B40, B41, B42, B43, B48, B66</li> <li>• Supported FDD bands: B71 (600 MHz), B12 &amp; B13 &amp; B14 &amp; B17 &amp; B28 &amp; B29 (700 MHz), B20 (EU800 800 MHz), B5 &amp; B18 &amp; B19 &amp; B26 (850 MHz), B8 (900 MHz), B32 (L-band EU 1500 MHz), B4 (AWS-1 1700 MHz), B66 (1700 MHz), B3 (1800 MHz), B2 (1900 MHz), B25 (Extended PCS 1900 MHz), B1 (2100 MHz), B30 (WCS 2300 MHz), B7 (2600 MHz)</li> <li>• Supported TDD bands: B39 (1900 MHz), B34 (2000 MHz), B40 (2300 MHz), B41 (2500 MHz), B38 (2600 MHz), B42 &amp; B48 (3500 MHz), B43 (3700 MHz), B46 (LAA 5200 MHz)</li> <li>• Bandwidth: 1.4, 3, 5, 10, 15 and 20 MHz RF bandwidth</li> <li>• Bit rates: max. 1.0 Gbps (DL), max. 200 Mbps (UL)</li> <li>• Max. output power: 26 dBm <math>\pm</math>2 dB (Class 2)</li> </ul>
UMTS parameters	<ul style="list-style-type: none"> <li>• 3GPP Rel-9 DC-HSDPA, HSPA+, HSDPA, HSUPA and WCDMA</li> <li>• Supported modulations: QPSK, 16QAM and 64QAM</li> <li>• Supported bands: B6 &amp; B19 (800 MHz), B5 (850 MHz), B8 (900 MHz), B4 (AWS A-F 1700 MHz), B3 (1800 MHz), B2 (PCS A-F 1900 MHz), B1 (2100 MHz)</li> <li>• DC-HSDPA: max. 42 Mbps (DL)</li> <li>• HSUPA: max. 5.76 Mbps (DL)</li> <li>• WCDMA: 384 kbps (DL) / 384 kbps (UL)</li> <li>• Max. output power: 24 dBm +1/-3 dB (Class 3)</li> </ul>

Table 20: Technical Parameters of Cellular Module

### 3.4.1 Module Antenna Mapping

SMA	WCDMA	LTE	5G NR			LB (MHz)	MHB (MHz)	n77/n78 (MHz)	n79 (MHz)
			Refarmed	n41	n77/n78/n79				
ANT0	MHB_TRX	MHB_TRX, UHB_PRX <sup>1</sup> MIMO	MHB_TRX, UHB_PRX <sup>1</sup> MIMO	TRX1 <sup>2</sup>	PRX MIMO	-	1452-2690	3300-4200	4400-5000
ANT1	LB_TRX	LB_TRX, MHB_DRX MIMO, UHB_PRX <sup>1</sup> MIMO, LAA PRX	LB_TRX, MHB_DRX MIMO, UHB_DRX <sup>1</sup> MIMO	DRX1 <sup>2</sup>	DRX MIMO	617-960	1452-2690	3300-4200	4400-6000
ANT2	LB_DRX	LB_DRX, MHB_PRX MIMO, UHB_TRX <sup>1</sup>	LB_DRX, MHB_PRX MIMO, UHB_TRX <sup>1</sup>	TRX0 <sup>2</sup>	TRX	617-960	1452-2690	3300-4200	4400-5000
ANT3	MHB_DRX	MHB_DRX, UHB_DRX <sup>1</sup> , LAA_DRX	MHB_DRX, UHB_DRX <sup>1</sup>	DRX0 <sup>2</sup>	DRX	-	1452-2690	3300-4200	4400-6000

Table 21: Cellular Module Antenna Mapping

<sup>1</sup>UHB frequency range: 3400-3800 MHz.

<sup>2</sup>NR TRX1 = TX MIMO + PRX MIMO; NR DRX1 = DRX MIMO

### 3.5 Parameters of GNSS

Parameter	Description
GNSS Systems	GPS, GLONASS, QZSS, BeiDou/COMPASS, Galileo
Antenna	Input impedance: 50 $\Omega$ Connector type: SMA Power mode: active antenna support
Features	Protocol: NMEA 0183 Data update rate: 1 Hz
Frequency	GPS/Galileo/QZSS (GPS L1): 1575.42 $\pm$ 1.023 MHz GPS/Galileo/QZSS (GPS L5): 1176.45 $\pm$ 10.23 MHz Galileo (E1): 1575.42 $\pm$ 2.046 MHz QZSS (L1): 1575.42 MHz GLONASS: 1597.5–1605.8 MHz BeiDou/COMPASS 1561.098 $\pm$ 2.046 MHz
Sensitivity (autonomous)	Cold Start: -142 dBm Reacquisition: -154 dBm Tracking: -154 dBm
TTFF (autonomous)	Cold start: 36.26 s Warm start: 34.05 s Hot start: 1.22 s
Accuracy (CEP-50) (autonomous)	1.9 m (at open sky)

Table 22: Technical Parameters of GNSS

### 3.6 Parameters of WiFi

Parameter	Description
Short Module Description	Dual Band 2.4/5GHz 3x3 WiFi 5 (802.11ac Wave 1)
Supported Standards	IEEE: 802.11ac compliant & compatible with 802.11a/b/g/n
Antenna Connectors	3x3 MIMO RP-SMA Input impedance: 50 $\Omega$
Data Rate (3x3 MIMO OFDM)	Up to 600 Mbps @ 2.4 GHz Up to 1300 Mbps @ 5 GHz
Frequency Ranges	2.412 – 2.472 GHz 4.920 – 5.825 GHz
Spectrum Widths	20/40MHz @ 2.4GHz 20/40/80MHz @ 5GHz
Modulation Techniques	OFDM: BPSK, QPSK, DBPSK, DQPSK, 16-QAM, 64-QAM, 256-QAM
2.4 GHz supported channels	1, 2, 3, 4, 5, 6, 7, 8, 9, 10, 11, 12, 13
5 GHz supported channels	36, 38, 40, 42, 44, 46, 48, 52, 56, 60, 64, 100, 104, 108, 112, 116, 120, 124, 128, 132, 136, 140, 149, 153, 157, 161, 165
Type of device	Access point (AP) Station (STA) Multi-role (AP & STA)
Key Features	Spatial Multiplexing, Cyclic-Delay Diversity (CDD), Low-Density Parity Check (LDPC) Codes, Maximal Ratio Combining (MRC), Space Time Block Code (STBC), Dynamic Frequency Selection (DFS), IEEE 802.11d, e, h, i, j, k, r, v time stamp, and w standards
Security – Standards	WPA, WPA2, WPA3, 802.1X
Security – Encryption	WEP, TKIP, AES
Security – EAP Types	EAP-FAST, EAP-TLS, EAP-TTLS, PEAP-GTC, PEAP-MSCHAPv2, PEAP-TLS, LEAP
TX Power (per chain)	Max. 21 dBm @ 2.4 GHz Max. 18 dBm @ 5 GHz

Table 23: Technical Parameters of WiFi



### 3.7 Parameters of I/O Ports

Electrical characteristics of the digital input are in Table 24. Status of the digital input can be retrieved in the router's web interface (on the *General Status* page) or by the `status ports` and `io get` commands, see *Command Line Interface* application note.

Logical <sup>1</sup>	Voltage	Current	Status <sup>2</sup>
1	3 V	0.5 mA	Off
0	5 V	0.8 mA	On
0	12 V	1.6 mA	On
0	48 V	3.4 mA	On

Table 24: Electrical Characteristics of Digital Input

The maximum digital output load is **500 mA** at **48 V**.

### 3.8 Parameters of Serial Interfaces

Supported parameters of the RS232 and RS485 interfaces, which can be configured in *Expansion Port 1* resp. *Expansion Port 2* menu items, are in Table 25.

Parameter	Description
Baudrate	300, 600, 1200, 2400, 4800, 9600, 19200, 38400, 57600, 115200, 230400.
Data Bits	5, 6, 7, 8.
Parity	none, even, odd.
Stop Bits	1, 2.
Flow Control	none, hardware.

Table 25: Parameters of Serial Interfaces

<sup>1</sup>The digital status returned by the `io get` shell command.

<sup>2</sup>The digital status returned by the `status ports` shell command and displayed on the *General Status* page.

## 3.9 Parameters of PoE

For more information about the PoE PSE feature, including the parameters, see Chapter 2.4.

## 3.10 System Configuration

The main parameters of the system are listed in Table 26.

Parameter	Description
CPU architecture	Quad-Core ARMv8-A (core Cortex-A72)
CPU frequency	1200 MHz
CPU power	4.72 DMIPS/MHz
Flash memory	4 MB of NOR 4 096 MB of eMMC <ul style="list-style-type: none"> <li>• 838 MB for Router Apps</li> <li>• 512 MB for customer data</li> <li>• The remaining space is reserved for the system.</li> </ul>
RAM size	1 024 MB
Watchdog	HW watchdog
RTC	Battery backup RTC
TPM	Trusted Platform Module (TPM) 2.0
SIM Slots	2× SIM (Mini SIM – 2FF) 1× Chip SIM (MFF2) <sup>1</sup>

Table 26: System Configuration

<sup>1</sup>Not assembled by default, for dedicated customer orders only.

# Appendix A: Troubleshooting

If you cannot connect to the router from your PC, your network card may be configured in such a way that it is not possible to connect to the router. Take one or more of the following steps in order to solve the problem:

- Make sure your PC's network card is configured to obtain the IP address from the DHCP server (by default the DHCP server is running in the router).
- Connect the router to the PC via Switch.
- Connect the router to the PC, start the router first and then start the PC after the router's initialization.

## Ethernet connection fails or is not establishing.

- It is possible to turn auto negotiation off and set a rate and duplex manually on the Ethernet interface of the router. Available on "LAN Configuration" page in the router.

## Mobile WAN connection fails.

- Check the signal power ("Mobile WAN status" page). If the signal power is weak, you will have to use a better antenna. If the neighbouring cells have a similar signal strength, you will need to use a directional antenna. For proper operation, the signal levels have to be good.
- Try to enable automatic ping from the router, which will check the connection when there are no data running and in the case of a failed ping, restart the connection. This can be done on the "Mobile WAN Configuration" page in the router in the "Check connection" section. "Enable + bind" option is to ensure the ping goes always through Mobile WAN network interface.

## Mobile WAN connection cannot be established.

- Check the "Mobile WAN Configuration" – APN, name, password and IP address (all can be blank).
- Try to enter the SIM card PIN – verify that the SIM card has the PIN code entered. Available on "Unlock SIM Card" page in the "Administration" section.
- In a private APN it is not recommended to get the DNS settings from operator (on "Mobile WAN" page)
- Go to "System Log" page in "Status" section and observe where the error occurs.

## I cannot connect from the Internet to the device behind the router. I have NAT enabled.

- The device's gateway has to be configured so it points to the router.

## I can't access my Web server placed behind the router over NAT.

- The remote HTTP access to the router has to be disabled on "NAT Configuration" page in the router. Also enable "Send all remaining incoming packets to default server" feature and fill in the IP address of your Web server. On the Web server, the default gateway has to be the IP address of the router.

## DynDNS doesn't work.

- With private APN this will not work.

- If the same IP address is recorded in your canonic name as a dynamically assigned address, it means that the operator is using NAT or a firewall.
- You can verify NAT using ping to your server with static address and then compare with router's IP address.
- You can verify a Firewall by accessing remotely to the router's Web interface.
- The operator may not provide the address of DNS server and without DNS server's address it is impossible to connect to the dyndns.org server. The following messages will be shown in the System Log:
  - DynDNS daemon started
  - Error resolving hostname: no such file or directory
  - Connect to DynDNS server failed

 **L2TP or IPSec isn't establishing.**

- Check the "System Log" page for error messages.

 **IPSec tunnel establishes but the communication does not run.**

- Probably there are bad routing rules defined in the connected devices, or the default gateway.

 **I switched the router to offline mode by SMS message, but the router is in online mode after reboot.**

- SMS messages do not change the router configuration. They remain in effect only until the router is rebooted.

### **Serial communication is not working.**

- Verify that the router model supports serial communications. Also verify the serial communication settings. To do so, open the router's configuration menu via the web browser, select the appropriate "Expansion Port" from "Configuration" part of the menu and verify the settings.

### **Is the router Cisco compatible? Can I use the Cisco configuration?**

- No, the Firmware in the router (ICR-OS) is based on Linux with BusyBox. Thus the Cisco configuration cannot be used. But network connections are defined by standards so connecting the router to the Cisco or other networking devices is possible and will be compatible.

### **FTP or SFTP does not work**

- FTP will work on v2 routers only. You can use SFTP on all routers to transfer files to/from the router. If having troubles with FTP on v2 routers, make sure you have FTP enabled: "Configuration" section, "Services", "FTP". Then you can connect with any client on port 21 with name and password same as for the Web interface. If having troubles with SFTP, make sure you have SSH enabled: "Configuration" section, "Services", "SSH". Then you can connect with any client on port 22 with name and password same as for the Web interface.

### **How can I connect to the router's command line? (SSH, Telnet)**

- You can use SSH on all routers or Telnet on v2 routers only. SSH is enabled by default, but you can verify in Web interface in "Configuration" section, "Services", "SSH". Then connect with any SSH client on port 22 of the router. User and password is the same as for the Web interface. Telnet on v2 routers can be enabled here: "Configuration" section, "Services", "Telnet".

# Appendix B: Customer Support

## Customer Support for Europe

### Advantech Czech s.r.o.

Sokolska 71  
562 04, Usti nad Orlici  
Czech Republic

Phone: +353 91 792444  
Fax: +353 91 792445  
E-mail: [iiotcustomerservice@advantech.eu](mailto:iiotcustomerservice@advantech.eu)  
Web: [www.advantech.com](http://www.advantech.com)

## Customer Support for NAM

### Advantech B+B SmartWorx

707 Dayton Road  
Ottawa, IL 61350 USA

Phone: +1-800-346-3119 (Monday – Friday, 7 a.m. to 5:30 p.m. CST)  
Fax: +1-815-433-5109  
E-mail: [support.iiot.ana@advantech.com](mailto:support.iiot.ana@advantech.com)  
Web: [www.advantech.com](http://www.advantech.com)

## Customer Support for Asia

Phone: +886-2-2792-7818 #1299 (Monday – Friday, 9 a.m. to 5:30 p.m. UTC+8)  
Fax: +886-2-2794-7327  
E-mail: [icg.support@advantech.com.tw](mailto:icg.support@advantech.com.tw)  
Web: [www.advantech.com](http://www.advantech.com)

# Appendix C: Regulatory & Safety Information

## Safety Notices



Please, observe the following instructions:

- The router must adhere to all relevant international and national laws, including any specific restrictions governing its use in designated applications and environments.
- To prevent potential injury and appliance damage, ensure compliance with regulations by using only authorized accessories. Unauthorized modifications or use of unapproved accessories could damage the router, violate regulations, and void the warranty.
- Do not attempt to open the router.
- Before handling the SIM card, turn off the router and disconnect it from the power supply.
- **Caution!** This equipment is not suitable for use in areas with children. Small children could swallow the SIM card.
- Ensure the power supply does not exceed 48 V DC maximum.
- Avoid exposing the router to extreme ambient conditions. Safeguard it against dust, moisture, and high temperatures.
- Only deploy routers with appropriate certification and labeling in environments containing flammable or explosive materials, such as gas stations, chemical plants, or areas involving explosives. Users must observe restrictions pertaining to radio device usage in such settings.
- When traveling by plane, switch off the router. Using it onboard could jeopardize flight operations, disrupt mobile networks, and potentially violate regulations. Non-compliance may result in telephone service suspension, cancellation, or legal repercussions.
- Exercise heightened caution when operating the router near personal medical devices like cardiac pacemakers or hearing aids.
- The router may cause interference when operated in close proximity to TV sets, radio receivers, or personal computers.
- It's advisable to create a suitable backup of all critical settings stored in the device's memory.



## Product Disposal Instructions

The WEEE (Waste Electrical and Electronic Equipment: 2012/19/EU) directive was introduced to ensure that electrical/electronic products are recycled using the best available recovery techniques to minimize the environmental impact. This product contains high quality materials and components which can be recycled. At the end of its life this product **MUST NOT** be mixed with other commercial waste for disposal. The device contains a battery. Remove the battery from the device before disposal. The battery in the device needs to be disposed of apart accordingly. Check the terms and conditions of your supplier for disposal information.

# Appendix D: Related Documents

[1] *ICR-4400 Configuration Manual* (see *Documents to download* → *Manuals* section)



[EP] Product-related documents and applications can be obtained on **Engineering Portal** at <https://icr.advantech.com/download> address.





We, Advantech Czech s.r.o., declare that the radio equipment narrated in this user's manual complies with Directive **2014/53/EU**.



We, Advantech Czech s.r.o., declare that the radio equipment narrated in this user's manual complies with Radio Equipment Regulations 2017 (**S.I. 2017 No. 1206**).

The full text of the EU Declaration of Conformity is available at the following internet address:  
[icr.advantech.com/doc](http://icr.advantech.com/doc)