

Hardware Manual

Industrial Cellular Router SmartFlex SR310

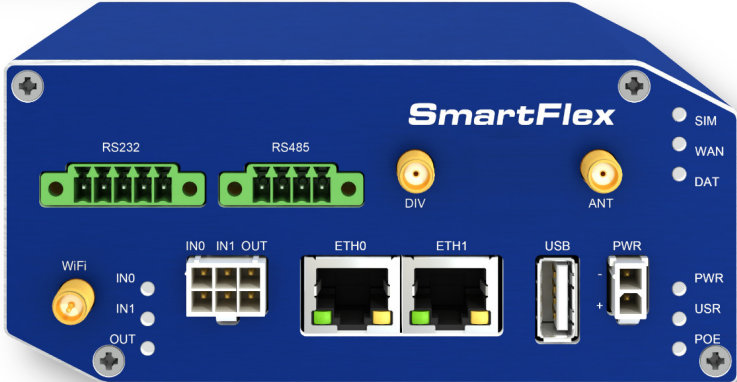
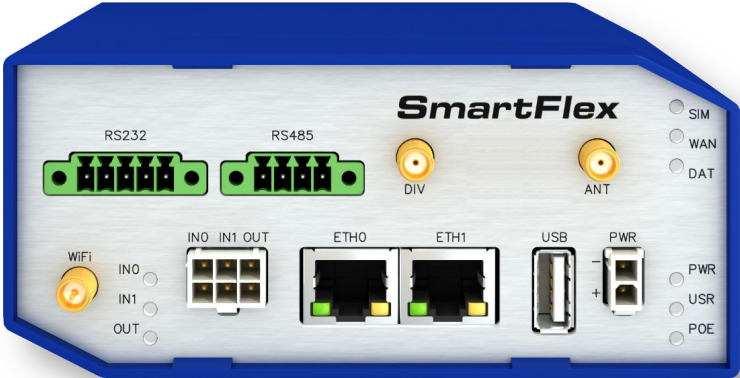

© 2025 Advantech Czech s.r.o. No part of this publication may be reproduced or transmitted in any form or by any means, electronic or mechanical, including photography, recording, or any information storage and retrieval system without written consent. Information in this manual is subject to change without notice, and it does not represent a commitment on the part of Advantech.

Advantech Czech s.r.o. shall not be liable for incidental or consequential damages resulting from the furnishing, performance, or use of this manual.

All brand names used in this manual are the registered trademarks of their respective owners. The use of trademarks or other designations in this publication is for reference purposes only and does not constitute an endorsement by the trademark holder.

Used symbols



Danger – Information regarding user safety or potential damage to the router.



Attention – Problems that can arise in specific situations.



Information – Useful tips or information of special interest.



Contents

1. Router Description	1
1.1 Usage of the Router	2
2. Contents of Package	5
3. Router Design	6
3.1 Router versions	6
3.2 Product Revisions	9
3.3 Delivery identification	9
3.4 Order codes	10
3.5 Basic dimensions of the router box	12
3.6 Mounting Recommendations	12
3.7 Removal from the DIN rail	13
3.8 Description of the rear panel	14
3.9 Description of the front panel	14
3.9.1 Status indication	15
3.9.2 Power connector PWR	16
3.9.3 Antenna connector ANT, DIV and WiFi	17
3.9.4 Japan Antenna Certification	18
3.9.5 Antenna List	18
3.9.6 SIM card slot	19
3.9.7 MicroSD card reader	20
3.9.8 Ethernet Ports (ETH0 and ETH1)	21
3.9.9 Power over Ethernet (PoE)	22
3.9.10 USB Port	24
3.9.11 I/O Port	25
3.9.12 Reset	27
3.10 Interfaces Description	28
3.10.1 SWITCH Interface	28
3.10.2 RS232-RS485/422 Interface	29
3.10.3 RS232-RS485-ETH Interface	32
4. First Use	35
4.1 Connecting the router before first use	35
4.2 Start	36
4.3 Configuration	36
4.3.1 Configuration by web browser	36
5. Technical Parameters	38
5.1 Basic parameters	38
5.2 Standards and regulations	39
5.3 Type tests and environmental conditions	40
5.4 Technical parameters of cellular module	41
5.5 Technical parameters of WiFi	42
5.6 Technical parameters of I/O port	42

5.7	Technical Parameters of Power over Ethernet (PoE)	43
5.8	Other Technical Parameters	43
Appendix A: Troubleshooting		44
Appendix B: Customer Support		47
Appendix C: Regulatory & Safety Information		48
Appendix D: Related Documents		49

List of Figures

1	Access to the Internet from LAN	2
2	Backed up access to the Internet	3
3	Using VPN tunnel	3
4	Serial Gateway	4
5	Contents of package	5
6	Basic version (plastic)	6
7	Basic version with WiFi (plastic)	6
8	Basic version (metal)	6
9	Basic version with WiFi (metal)	6
10	Version SWITCH (plastic)	7
11	Version SWITCH and WiFi (plastic)	7
12	Version RS232-RS485 (plastic)	7
13	Ver. RS232-RS485 & WiFi (plastic)	7
14	Version SWITCH (metal)	7
15	Version SWITCH and WiFi (metal)	7
16	Version RS232-RS485 (metal)	7
17	Version RS232-RS485 & WiFi (metal)	7
18	Version RS232-RS485-ETH (plastic)	8
19	RS232-RS485-ETH & WiFi (plastic)	8
20	Version RS232-RS485-ETH (metal)	8
21	RS232-RS485-ETH & WiFi (metal)	8
22	Label examples	9
23	Basic dimensions of the router box	12
24	Default position of plastic and metal DIN rail clip	13
25	Removal from the DIN rail	13
26	SmartFlex front panel	14
27	Power connector	16
28	Connection of power supply	16
29	Connecting of the antenna	17
30	Antenna Certification Mark for Quectel EG25-G	18
31	Antenna Certification Mark for Texas Instrument WL18MODGI	18
32	SIM cards	19
33	MicroSD card	20
34	Ethernet connector	21
35	Connection of Ethernet cable	21
36	PoE PD usage	22
37	PoE PSE usage	23
38	USB connector	24
39	I/O connector	25
40	Binary connection	26
41	Router reset	27
42	Version with SWITCH board	28
43	Version with RS232-RS485/422 interface	29
44	RS232 connector	29
45	RS485/422 connector	30
46	Version with RS232-RS485-ETH interface	32
47	Ethernet connector	32

48	RS485 connector	33
49	RS232 connector	33
50	Router connection	35
51	Entering the IP address of the router	36
52	Entering login information	36
53	Router web interface	37

List of Tables

1	Router versions	6
2	HW Revisions History	9
3	Delivery identification	9
4	Order codes overview	10
5	Power over Ethernet	10
6	Type of router box	10
7	Type of power supply plug	11
8	Examples of order code	11
9	Front panel description	14
10	LED status indication	15
11	Connection of power connector	16
12	Quectel EG25-G Antenna List	18
13	Texas Instrument WL18MODGI Antenna List	18
14	Technical specifications of microSD card	20
15	Ethernet connector pinout	21
16	Insulation strength of Ethernet ports	21
17	Connection of USB connector	24
18	Connection of I/O port	25
19	Characteristics of inputs	25
20	Description of router reset and restart	27
21	State indication of the SWITCH interface	28
22	SWITCH interface parameters	29
23	Connection of RS232 connector	29
24	Connection of RS485 connector	30
25	Connection of RS422 connector	30
26	Technical specification of RS232 and RS485	31
27	Connections of the Ethernet Connector	32
28	Connections of Terminal Block Connector RS485	33
29	Connections of Terminal Block Connector RS232	33
30	State indication of the RS232-RS485-ETH interface	34
31	Technical specification of RS232, RS485 and Ethernet	34
32	Basic parameters	38
33	Standards and regulations	39
34	Type tests and environmental conditions	40
35	Technical parameters of cellular module	41
36	Technical parameters of WiFi	42
37	Characteristics of inputs	42
38	PoE PSE parameters	43
39	Other technical parameters	43

1. Router Description

SmartFlex SR310 is an industrial cellular router intended for the global markets. This router is an ideal device for wireless communication in mobile networks that make use of LTE, UMTS, EDGE or GPRS technology. Due to the high speed of data transfer up to 130 Mbps (download) and up to 30 Mbps (upload) is this router an ideal solution for specialized M2M devices and IoT as well as for wireless connection of traffic and security camera systems, individual computers, LAN networks, automatic teller machines (ATM) and other self-service terminals.

The standard configuration includes two Ethernet 10/100 ports, one USB 2.0 Host port, two binary inputs and one output (I/O connector). The device also has two readers for 3 V and 1.8 V SIM cards, which are located on the rear panel of the router. The router also includes a microSD card port that supports up to 64 GB card storage (32 GB in the case of SDHC cards). The router can be equipped with a WiFi module, but this must be part of the initial configuration – it cannot be assembled to the router at some point in the future.

The router can be equipped with PoE PD (Power over Ethernet – Powered Device), which allows the router to be powered via Ethernet. It can also be equipped with PoE PSE (Power over Ethernet – Power Source Equipment), which lets the router to power other devices via Ethernet. The SmartFlex router can also be configured with a wide variety of port options. These can be SWITCH – three switched Ethernet ports; RS232-RS485/422 – combination of serial interfaces; RS232-RS485-ETH – combination of serial interfaces and Ethernet port with higher insulation. The router can be provided in either a plastic or metal casing, depending upon the customer's requirements.

Configuration of the router may be done via a password-protected Web interface. Web interface provides detailed statistics about the router's activities, signal strength, detailed system log etc. The router supports the creation of VPN tunnels using IPSec, OpenVPN and L2TP to ensure safe communication. DHCP, NAT, NAT-T, DynDNS, NTP, VRRP, control by SMS, backup primary connection and many other functions are supported.

The router provides diagnostic functions which include automatically monitoring the PPP connection, automatic restart in case of connection losses, and a hardware watchdog that monitors the router status. The user may insert Linux scripts which are started on various actions. It is possible to create up to four different configurations for the same router. These configurations can be switched whenever necessary via Web interface, SMS or binary input status. The router can automatically upgrade its configuration and firmware from your central server. This allows for mass reconfiguration of numerous routers at the same time.

The router supports automatic upgrades of both its configuration and firmware, leveraging updates from a central server. This feature ensures that the router remains up-to-date with the latest enhancements and security protocols.

This model is compatible with Advantech's remote device management platforms: [WebAccess/DMP](#) and [WebAccess/VPN](#). These platforms facilitate comprehensive management and monitoring of network devices.

i Examples of possible applications

- mobile office
- fleet management
- security system
- telematic
- telemetric
- remote monitoring
- vending and dispatcher machines

1.1 Usage of the Router

The router is primarily intended for these four basic situations:

I. Access to the Internet from LAN

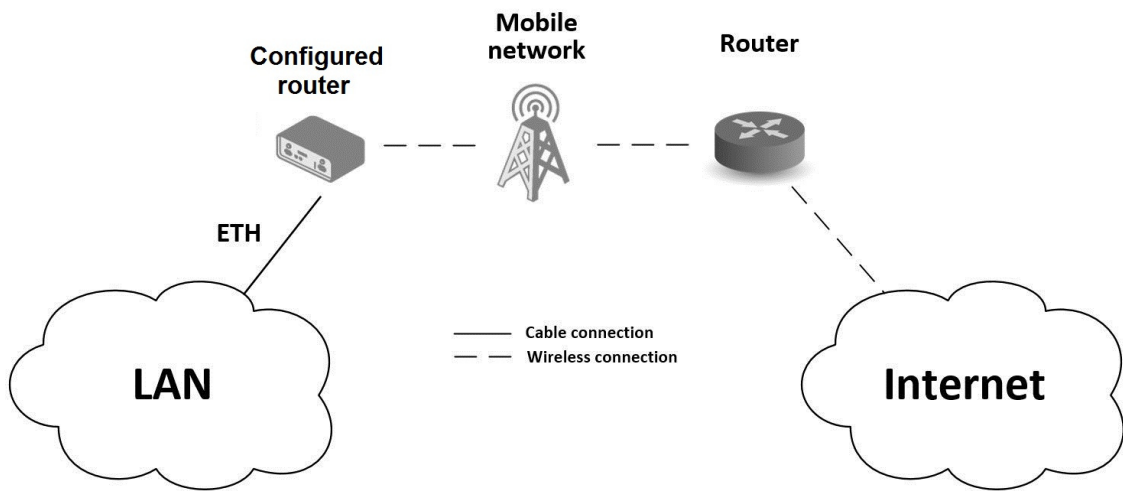

Figure 1: Access to the Internet from LAN

II. Backed up access to the Internet (from LAN)

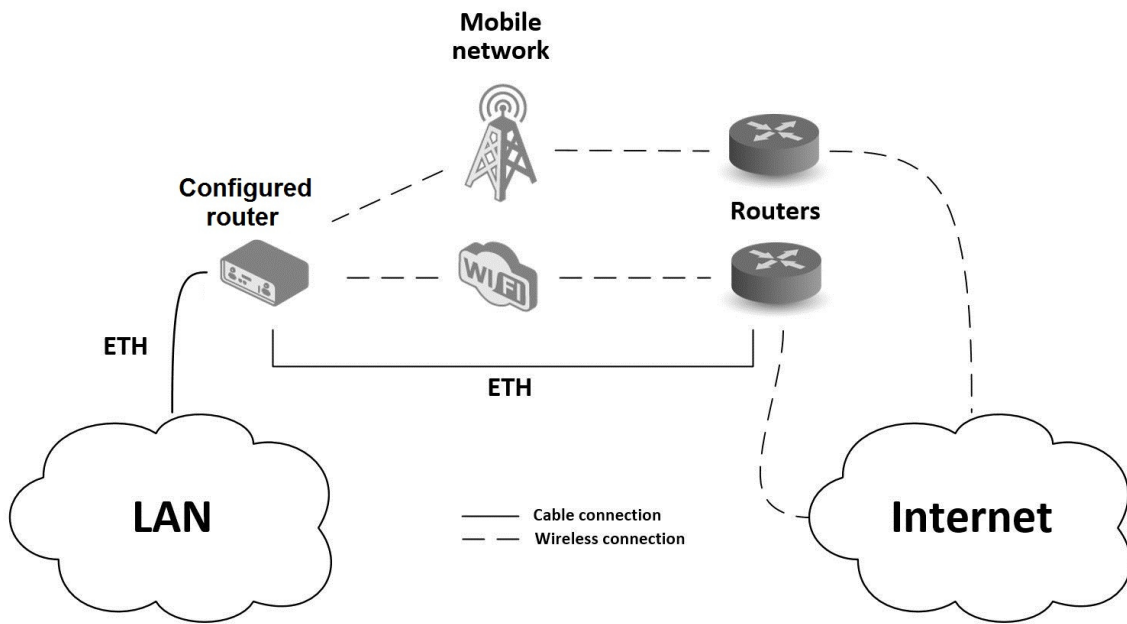

Figure 2: Backed up access to the Internet

III. Secure networks interconnection or using VPN

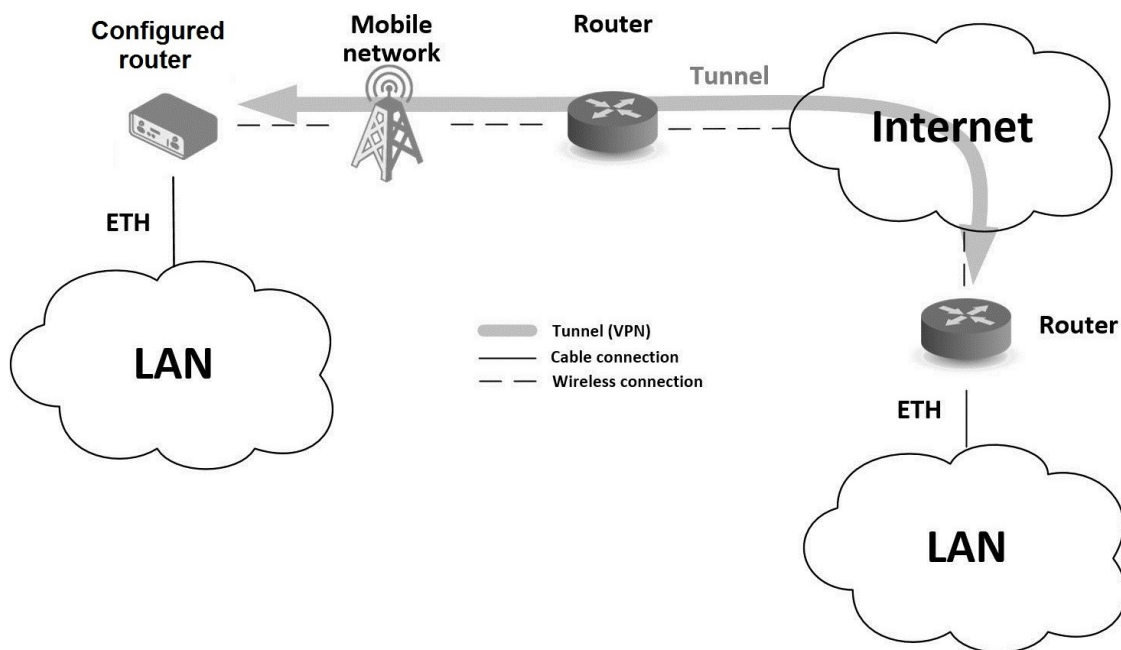

Figure 3: Using VPN tunnel

IV. Serial Gateway

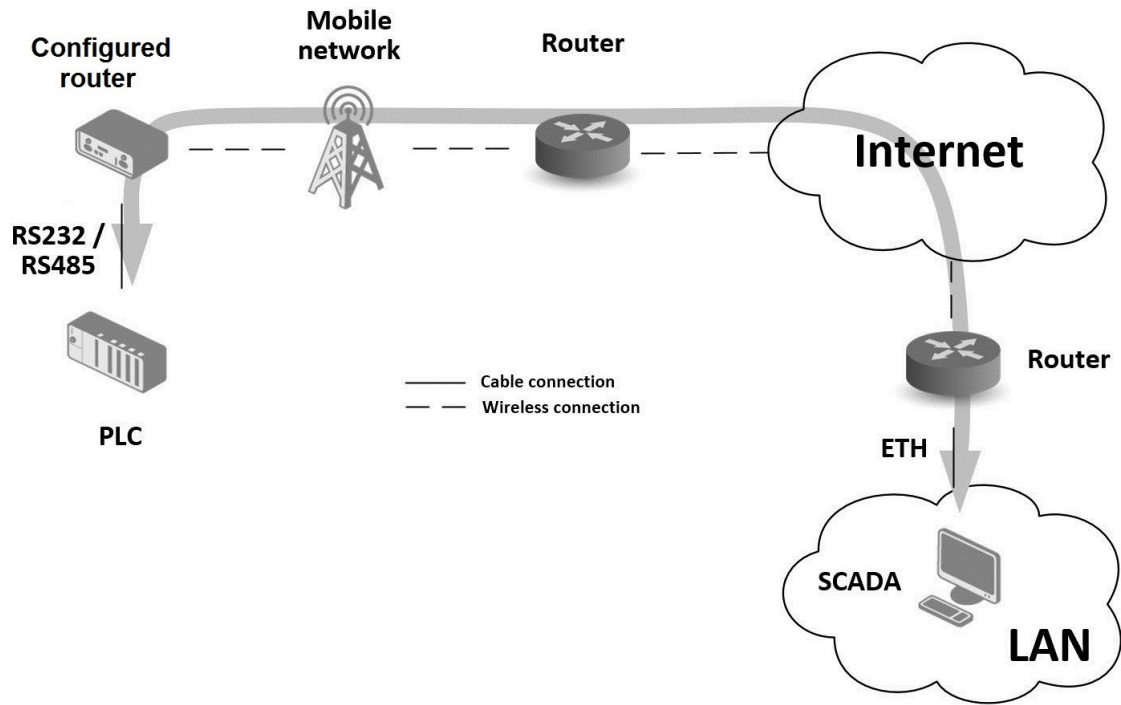

Figure 4: Serial Gateway

2. Contents of Package



Basic delivered set of router includes:

- router,
- power supply,
- crossover UTP cable,
- up to three external antennas,
- loose power and I/O connector (+8 pins¹),
- 4-pins and 5-pins terminal block for RS485 and RS232 (**only for version with interface RS232-RS485/422**),
- 2 pieces of 5-pins terminal block for RS485 (**only for version with interface RS485-RS485**),
- 3-pins and 4-pins terminal block for RS485 and RS232 (**only for version with interface RS232-RS485-ETH**),
- clip for the DIN rail,
- printed *Quick Start Guide Leaflet*.



Figure 5: Contents of package



Temperature range for power supply is reduced to 0 °C to +40 °C!

¹These pins are designed for cables with a diameter from 0.2 to 0.8 mm²

3. Router Design

3.1 Router versions



Check with your local Advantech sales representative for available options and HW configurations.

SmartFlex SR310 router is supplied in the following versions (see table below). All versions are available in plastic or metal box according to customer requirements. All versions are available with PoE PD (Power over Ethernet – powered device) so you can power the router from both ETH0 and ETH1 interfaces, or with PoE PSE (power source equipment) so you can power other devices by the router.

Router versions	SIM	BIN	BOUT	USB	SD	ETH	WiFi	232	485
Basic version	2 x	2 x	1 x	1 x	1 x	2 x			
Basic version with WiFi	2 x	2 x	1 x	1 x	1 x	2 x	1 x		
Version with SWITCH board	2 x	2 x	1 x	1 x	1 x	5 x			
Version with SWITCH board & WiFi	2 x	2 x	1 x	1 x	1 x	5 x	1 x		
Version with RS232-RS485/422 board	2 x	2 x	1 x	1 x	1 x	2 x		1 x	1 x
Version with RS232-RS485/422 & WiFi	2 x	2 x	1 x	1 x	1 x	2 x	1 x	1 x	1 x
Version with RS232-RS485-ETH board	2 x	2 x	1 x	1 x	1 x	3 x		1 x	1 x
Version with RS232-RS485-ETH & WiFi	2 x	2 x	1 x	1 x	1 x	3 x	1 x	1 x	1 x

Table 1: Router versions

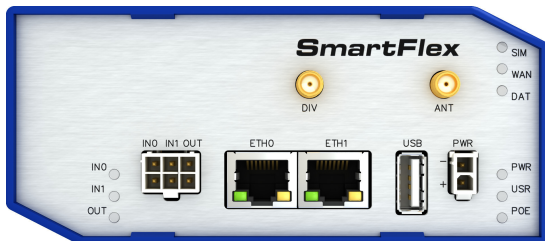

Figure 6: Basic version (plastic)

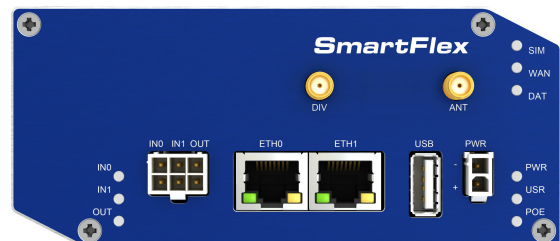

Figure 8: Basic version (metal)

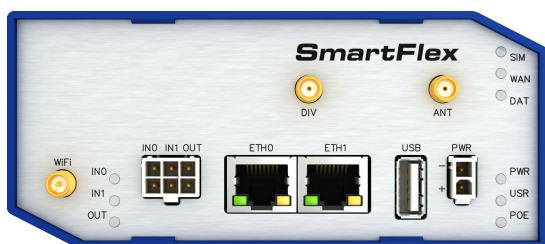

Figure 7: Basic version with WiFi (plastic)



Figure 9: Basic version with WiFi (metal)

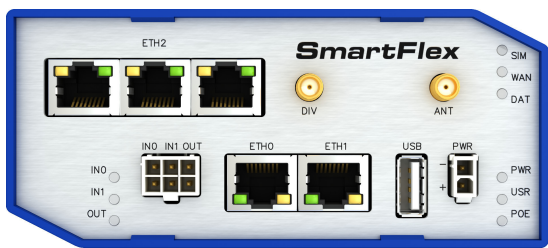

Figure 10: Version SWITCH (plastic)

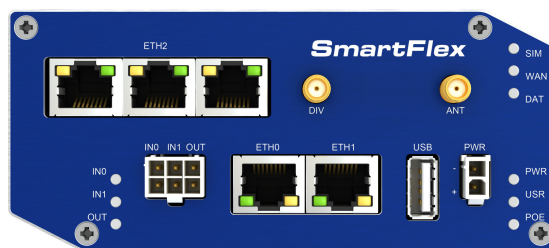

Figure 14: Version SWITCH (metal)

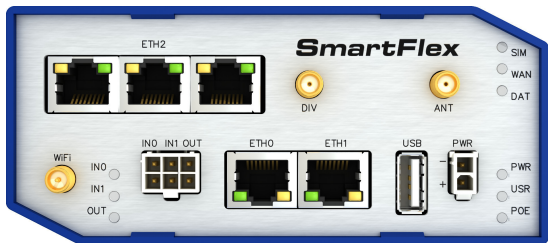

Figure 11: Version SWITCH and WiFi (plastic)

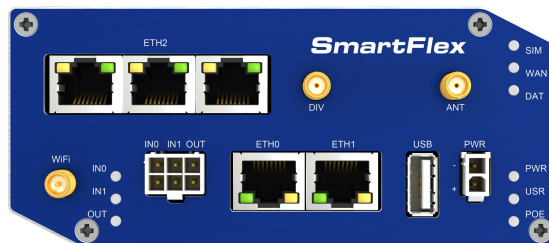

Figure 15: Version SWITCH and WiFi (metal)

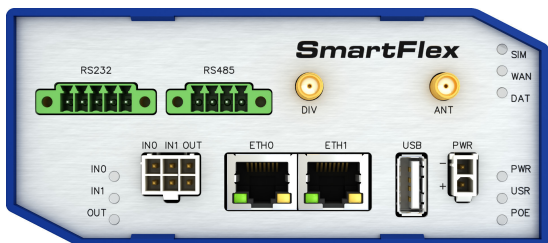

Figure 12: Version RS232-RS485 (plastic)

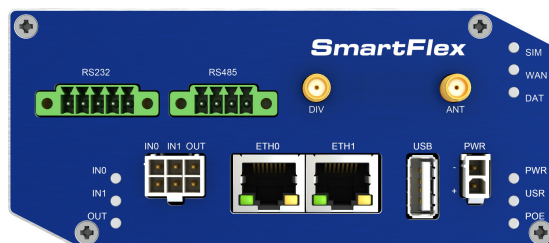

Figure 16: Version RS232-RS485 (metal)

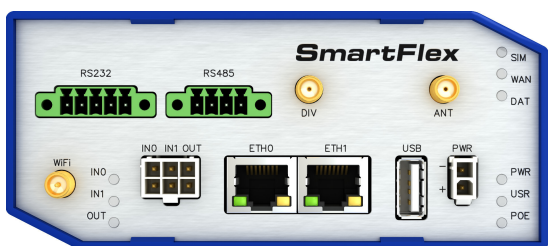

Figure 13: Ver. RS232-RS485 & WiFi (plastic)

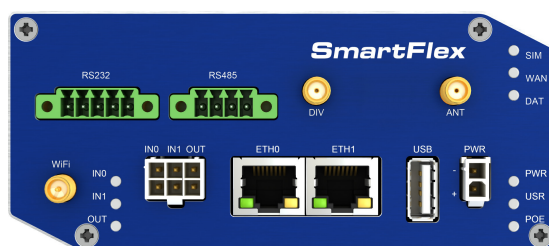

Figure 17: Version RS232-RS485 & WiFi (metal)

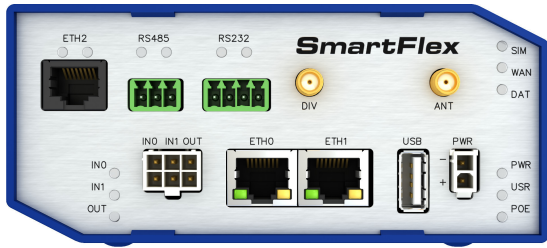

Figure 18: Version RS232-RS485-ETH (plastic)

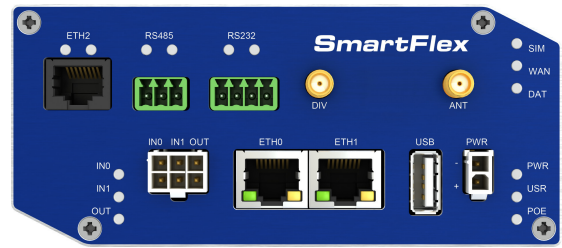

Figure 20: Version RS232-RS485-ETH (metal)

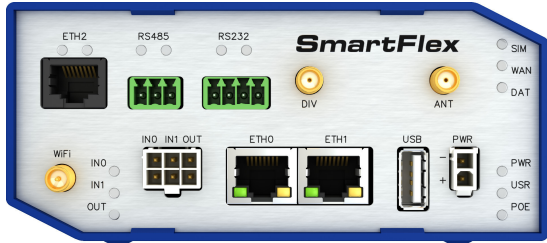

Figure 19: RS232-RS485-ETH & WiFi (plastic)

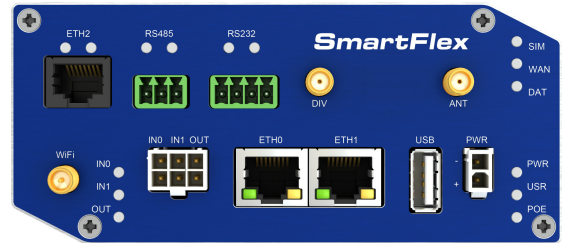

Figure 21: RS232-RS485-ETH & WiFi (metal)

3.2 Product Revisions

For the product revision history of the entire product platform, refer to the table below. Please note that some revisions may not be available for certain order codes. The revision number is printed on both the packaging and product labels.

The router GUI can also display the product revision under *Status* → *General* → *System Information* → *Product Revision*. Please note that the default revision (Rev. 1.0) may not be available here.

Rev.#	Description
1.0	Initial version (revision number not printed on the labels).
2.0	New SIM slot type; see PCN-2022-03 for details.

Table 2: HW Revisions History

3.3 Delivery identification

Trade name	Product name	Description
SmartFlex SR310	SmartFlex	Router in a plastic or metal box

Table 3: Delivery identification

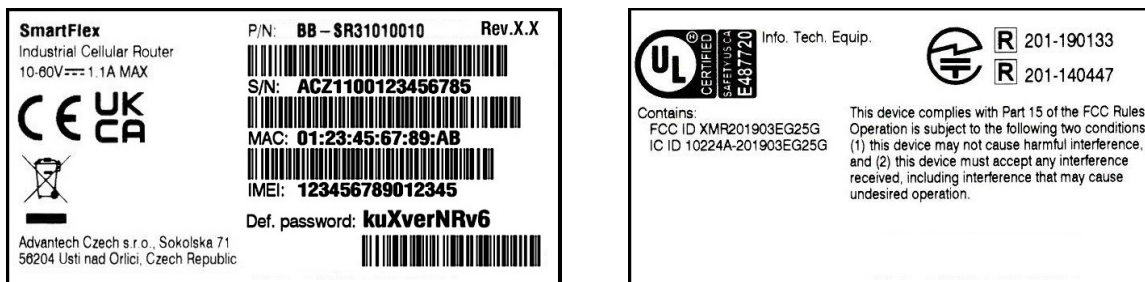

Figure 22: Label examples

3.4 Order codes

Order codes overview is shown in the table below.

Product Name	Order code	Features – interfaces
SR310	BB-SR3100x0yz*	LTE global module, 2x ETH, 1x USB, 2x BI, 1x BO, 1x microSD reader, 2x SIM reader
SR310	BB-SR3101x0yz*	LTE global module, 2x ETH, 1x USB, 2x BI, 1x BO, 1x microSD reader, 2x SIM reader, WiFi
SR310	BB-SR3100x1yz*	LTE global module, 5x ETH, 1x USB, 2x BI, 1x BO, 1x microSD reader, 2x SIM reader
SR310	BB-SR3101x1yz*	LTE global module, 5x ETH, 1x USB, 2x BI, 1x BO, 1x microSD reader, 2x SIM reader, WiFi
SR310	BB-SR3100x3yz*	LTE global module, 2x ETH, 1x USB, 2x BI, 1x BO, 1x microSD reader, 2x SIM reader, RS232, RS485
SR310	BB-SR3101x3yz*	LTE global module, 2x ETH, 1x USB, 2x BI, 1x BO, 1x microSD reader, 2x SIM reader, WiFi, RS232, RS485
SR310	BB-SR3100x4yz*	LTE global module, 3x ETH, 1x USB, 2x BI, 1x BO, 1x microSD reader, 2x SIM reader, RS232, RS485
SR310	BB-SR3101x4yz*	LTE global module, 3x ETH, 1x USB, 2x BI, 1x BO, 1x microSD reader, 2x SIM reader, WiFi, RS232, RS485

Table 4: Order codes overview



* Replace the letters "x", "y" and "z" with the values from the following tables:

Letter "x" – Power over Ethernet (PoE)

Power over Ethernet (PoE)	Number "x" in code
Version without PoE	0
PoE PSE – Power Source Equipment – powers other devices	8
PoE PD – Powered Device – can be powered via Ethernet	9

Table 5: Power over Ethernet

Letter "y" – type of the router box

Type of box	Number "y" in code
Plastic	1
Metal	2

Table 6: Type of router box

Letter "z" – type of power supply plug

Plug type	Number "z" in code
Without accessories	0
European	1
Interchangeable plug adapters (EU, US, UK, AUS)	5

Table 7: Type of power supply plug

Examples of complete order code:

Order code	Features – interfaces	Box	Plug type
BB-SR31000120	LTE global module, 5x ETH, 1x USB, 2x BI, 1x BO, 1x microSD reader, 2x SIM reader,	metal	–
BB-SR31008110	LTE global module, 5x ETH, 1x USB, 2x BI, 1x BO, 1x microSD reader, 2x SIM reader, PoE PSE	plastic	–
BB-SR31010015	LTE global module, 2x ETH, 1x USB, 2x BI, 1x BO, 1x microSD reader, 2x SIM reader, WiFi	plastic	universal
BB-SR31010425	LTE global module, 3x ETH, 1x USB, 2x BI, 1x BO, 1x microSD reader, 2x SIM reader, WiFi, RS232, RS485	metal	universal

Table 8: Examples of order code

3.5 Basic dimensions of the router box

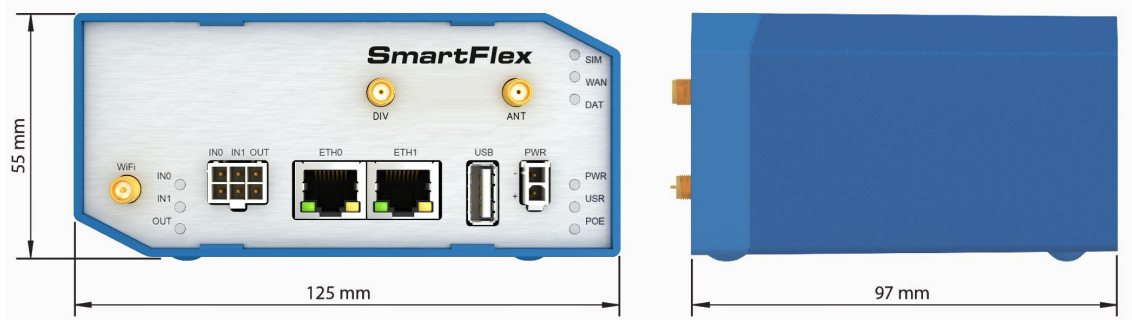

Figure 23: Basic dimensions of the router box

3.6 Mounting Recommendations

- It is possible to place the router on a flat surface,
- DIN rail EN 60715 with the included plastic or metal clip.

For most applications with a built-in router within a switchboard, it is possible to recognize two kinds of environments:

- A non-public, industry environment of low voltage with high interference,
- a public environment of low voltage and without high interference.

For both of these environments, it is possible to mount the router to a switchboard, after which there is no need to have examination immunity or issues in connection with EMC according to EN 61439-1:2011.



In compliance with the EN 61439-1:2011 specification, it is necessary to observe the following assembly instructions for a router attached to a switchboard:

- For whip antennas it is recommended to observe a minimum distance of 6 cm from cables and metal surfaces on every side in order to avoid interference. When using an external antenna separate from the switchboard it is necessary to fit a lightning conductor.
- When mounting a router on sheet-steel we recommend using a cable antenna.
- For all cables, we recommend to bind the bunch, and for this we recommend:
 - The length of the bunch (the combination of power supply and data cables) should be a maximum 1.5 m. If the length of data cables exceeds 1.5 m or if the cable is leading towards the switchboard, we recommend installing surge protectors.
 - Data cables must not have a reticular tension of ~ 230 V/50 Hz or ~ 120 V/60 Hz.
- Sufficient space must be left between each connector for the handling of cables,
- To ensure the correct functioning of the router we recommend the use of an earth-bonding distribution frame for the grounding of the power supply of the router, data cables and antenna within the switchboard.

3.7 Removal from the DIN rail



The DIN rail clip is suitable for a DIN rail according to EN 60715 standard only. The default position of plastic or metal rail clip, which is used for mounting the router on a DIN rail, is shown in the following figure. Its position can be changed on some models (back or bottom). When changing the position of the DIN rail clip, tighten the screws with max. 0.4 Nm torque.

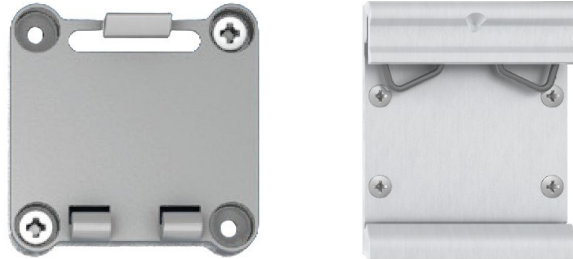

Figure 24: Default position of plastic and metal DIN rail clip

To remove the router from the DIN rail, push the router down lightly, so the bottom part of the DIN rail clip (hitched to the DIN rail) gets out of the rail and then pull out the bottom part of the router away from the DIN rail.

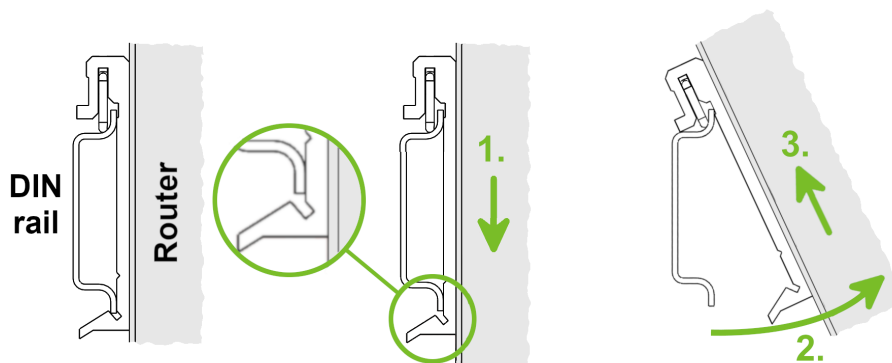

Figure 25: Removal from the DIN rail

3.8 Description of the rear panel

The rear panel contains two holders for SIM cards (*SIM1* and *SIM2*), a holder for microSD card (*SD*) and an *RST* button used to restore the default configuration and reboot the router.

3.9 Description of the front panel

On the front panel is the following:

Caption	Connector	Description
PWR	2-pin	Connector for the power supply
ETH0	RJ45	Connector for connection into the computer network, PoE (only for PoE PSE)
ETH1	RJ45	Connector for connection into the computer network, PoE (only for PoE PSE)
ANT	SMA	Connector for main antenna
DIV	SMA	Connector for diversity antenna
WiFi	R-SMA	Connector for WiFi antenna (only for versions with WiFi module!)
USB	USB-A 2.0 Host	Connector for connection of USB devices to the router. Supports devices with PL-2303 and FTDI USB/RS232 converters.
I/O	6-pin	Connector for connection of the binary inputs and output

Table 9: Front panel description

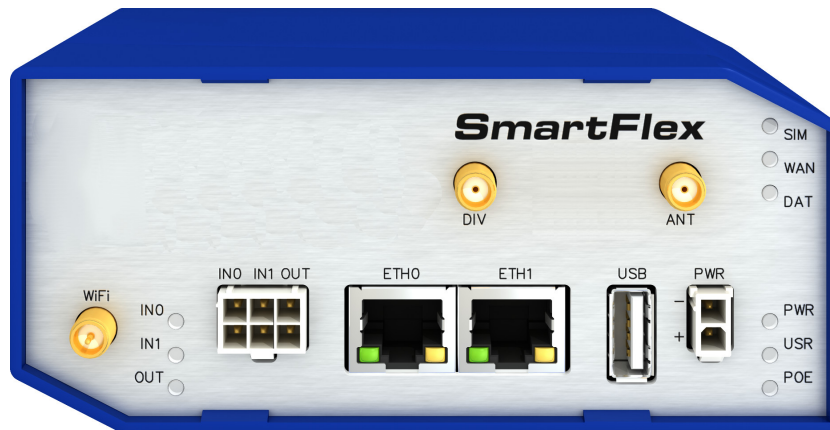

Figure 26: SmartFlex front panel

3.9.1 Status indication

There are status LEDs on the front panel to provide router status information. Each ETH port has two additional LEDs that provide information about the port status.

Caption	Color	State	Description
PWR	Green	Blinking On Fast blinking	The router is booting up. The router booted up and is ready. The router firmware is being updated.
USR	Yellow	—	The function of this LED is user-defined.
POE	Yellow	On Blinking	PSE: The insufficient voltage on the PWR connector. PSE: The powered device takes too much power. ¹
	Green	On	PD: The power supply is present on an ETH port. PSE: A correct power supply on the PWR connector.
		Blinking	PSE: A device is powered via one of the ETH ports.
		Off	PD: The power supply is not present on an ETH port. PSE: The PoE disabled in the Ethernet configuration.
SIM	Green	On (Green color)	The first SIM card is active.
	Yellow	On (Yellow color)	The second SIM card is active.
WAN	Yellow	Fades out 1x/5 s	Signal strength is good.
		Fades out 1x/2 s	Signal strength is fair ² .
		Fades out 1x/1 s	Signal strength is poor ³ .
			For value ranges of signal strength see <i>Configuration manual</i> , chapter <i>Mobile WAN Status</i> .
DAT	Red	Blinking	Cellular communication is in progress.
IN0	Green	On	The first binary input is active.
IN1	Green	On	The second binary input is active.
OUT	Yellow	On	The binary output is active.
ETH0 ETH1	Green	On	Selected 100 Mbps.
		Off	Selected 10 Mbps.
ETH0 ETH1	Yellow	On	The network cable is connected.
		Blinking	Data transmission.
		Off	The network cable is not connected.

Table 10: LED status indication



The status indication of the WAN LED is updated every 10 seconds.

¹Additionally it can indicate a device without PoE support connected on the other side of the cable. In this case the indication is caused by low impedance (lower than 500 Ω) of the device without PoE support. This can be solved by disabling the PoE PSE feature on the relevant ETH port in the router's Web interface, see *Configuration manual* [1].

²Or the difference between neighbouring cells is exactly 3 dBm.

³Or the difference between neighbouring cells is smaller than 3 dBm.

3.9.2 Power connector PWR

Panel socket 2-pin.

Pin number	Signal mark	Description
1	GND(-)	Negative pole of DC supply voltage
2	VCC(+)	Positive pole of DC supply voltage (+10 to +60 V DC)

Table 11: Connection of power connector

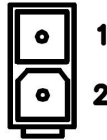

Figure 27: Power connector



Unit has to be supplied by a power supply specified as a Limited Power Source (LPS) according to Annex Q of IEC 62368-1. If the power supply/cable provided with device is not used, always use the cables with minimum wire size (nominal cross section) 0.5 square mm for power supply.

The power supply for the router must be between +10 V to +60 V DC supply. Protection against reversed polarity without signaling is built into the router. **Note:** The protection against reversed polarity is lost if the negative pole is grounded!



Circuit example:

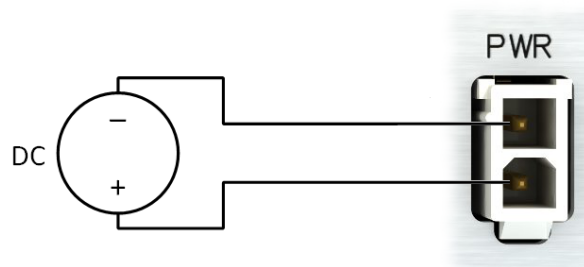

Figure 28: Connection of power supply



Note for PoE: See Chapter 3.9.9 for information on how PoE versions of the router impact the power supply usage. The power supply for a PoE router has to meet other specific requirements.



All metal parts are connected together with the negative pole of power supply (common pole).

Low Power Mode



In applications requiring low power consumption (such as solar power - not 7/24 mode) is strictly recommended to use LPM mode prior to powering down the entire router.

LPM (Low Power Mode) is a router mode where the router is in sleep mode with minimal power consumption. The router can be woken up from this mode by a signal applied to the BIN1 input or after a predetermined period of time. Putting the router into LPM mode can be done using the `lpm` command, see [Command Line Interface](#) application note for more details. Consumption in LPM mode may vary depending on the configuration of the router.

3.9.3 Antenna connector ANT, DIV and WiFi

Main and diversity antennas are connected to the router using the SMA connector on the front panel. There is also available R-SMA antenna connector through which the additional antenna can be connected, if the router is equipped with WiFi module.

ANT connector is used to connect the main antenna router. To connect the diversity antenna is used the second antenna connector *DIV*. R-SMA connector named *WiFi* is designed for connection of WiFi antenna (available only for versions with WiFi module).



The router can not operate without connected main antenna marked as *ANT*!



The *DIV* cellular antenna is required for the MIMO DL functionality.



For connection the antenna is used SMA connector. The antenna is connected by screwing this antenna to the SMA connector on the router's front panel (see the figure below).

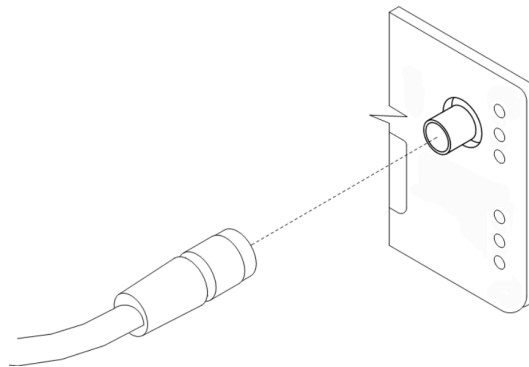

Figure 29: Connecting of the antenna



Diversity antenna improves radio features of the router at low signal strength.

3.9.4 Japan Antenna Certification

The internal wireless modules of this router have been certified by Japan Telec.

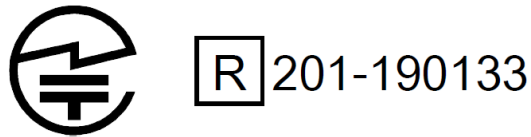

Figure 30: Antenna Certification Mark for Quectel EG25-G

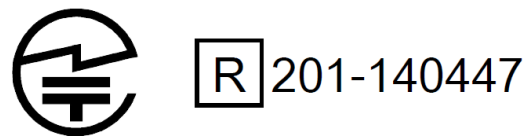

Figure 31: Antenna Certification Mark for Texas Instrument WL18MODGI

3.9.5 Antenna List

Quectel EG25-G

BB-2JW0124Z-C868B

BB-2J7041BGFA-300

MA931.A.LBICGH.001

Table 12: Quectel EG25-G Antenna List

Texas Instrument WL18MODGI

MA931.A.LBICGH.001

BB-AW-A2458G-FSRPK

Table 13: Texas Instrument WL18MODGI Antenna List

There is a maximum gain of 3 dBi in either LTE or WCDMA Band.



You can find more information about antennas on our website icr.advantech.com within *Certified Antennas.zip* file.

3.9.6 SIM card slot

Two SIM card slots for 3 V and 1.8 V SIM cards are located on the rear panel of the router. In order for the router to function, it is necessary to insert an activated SIM card with an unblocked PIN code. The SIM cards may have different APNs (Access Point Names) adjusted.

i Supported type of SIM cards: **Mini SIM** (2FF), dimensions 25.0 x 15.0 x 0.76 mm.

Changing the SIM card:

- Always disconnect the router from the power supply before handling the SIM card.
- To remove the SIM card, use the flat end of a spudger, or your fingernail, press the SIM card slightly into its slot until you hear a click.
- After hearing this click, release the card, and it will pop out of its slot.
- Remove the SIM card and push any other SIM card into the slot until it clicks into place.

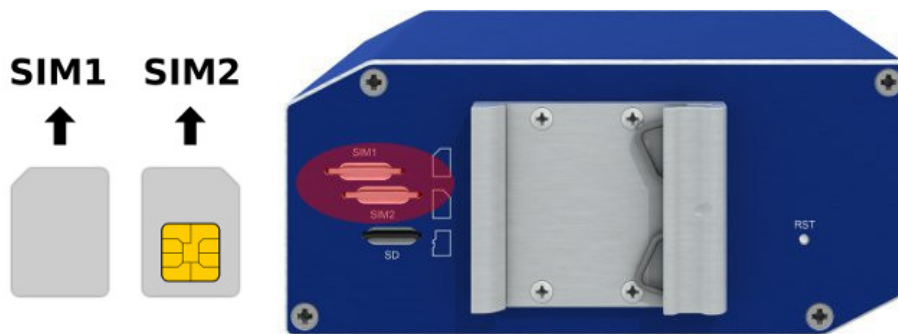

Figure 32: SIM cards

3.9.7 microSD card reader

The microSD card reader is located on the router's rear panel (the third slot). This card reader allows the router to operate with microSD memory cards. The technical specifications are stated in the table below. The microSD card changing procedure is described below.

Technical specifications of microSD card		
Supported technologies	SDHC, SDXC	
Supported capacity	SDHC SDXC	up to 32 GB from 32 GB to 64 GB
Supported microSD card filesystems	vfat, ext2, ext3, ext4	

Table 14: Technical specifications of microSD card

Changing the microSD card:

- To remove the microSD card, use the flat end of a spudger, or your fingernail, press the microSD card slightly into its slot until you hear a click.
- After hearing this click, release the card, and it will pop out of its slot.
- Remove the microSD card and push any other microSD card into the slot until it clicks into place.



Figure 33: MicroSD card

Mounting microSD Card to the System

It is necessary to mount the microSD card to be able to access it in the system of the router. Follow these steps to mount the card:

- Use the `dmesg` command to see the list of recently connected devices.
- In the output of the command find out the entry for the microSD card, for example:
`mmcblk0: p1`
- To mount the card to `/mnt` directory, use the `mount` command:
`mount /dev/mmcblk0p1 /mnt`



For more information about the commands for creating, mounting, checking and unmounting a file system on a microSD card, see the application note for [Ext4 Filesystem Utilities](#) router app.

3.9.8 Ethernet Ports (ETH0 and ETH1)

The panel socket RJ45 is used for this interface. The isolation barrier of the Ethernet signal ports against the ground is 1500 V.

Pin	10base-T & 100base-T	PoE (Mode B)
1	Tx+ (Transmit Data+)	—
2	Tx- (Transmit Data-)	—
3	Rx+ (Receive Data+)	—
4	—	PoE + (positive pole)
5	—	PoE + (positive pole)
6	Rx- (Receive Data-)	—
7	—	PoE - (negative pole)
8	—	PoE - (negative pole)

Table 15: Ethernet connector pinout

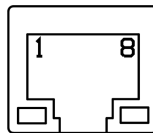

Figure 34: Ethernet connector

The crossover UTP cable (Ethernet cable) plugs into the RJ45 connector labeled as ETH0 or ETH1 (see the figure below).

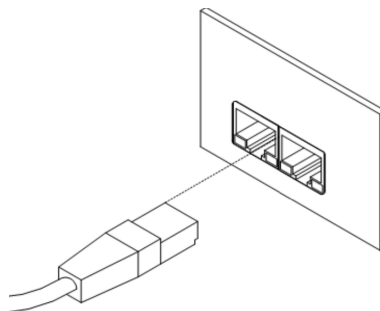

Figure 35: Connection of Ethernet cable







The insulation strength of Ethernet ports from each other and from the rest of the router (grounding) is dependent on the router version:

Router Version	Insul. Strength from Router	Insul. Strength between Ports
Without PoE	1.5 kV	1.5 kV
PoE PSE	none	none

Table 16: Insulation strength of Ethernet ports

3.9.9 Power over Ethernet (PoE)

-  Available only for models with PoE feature; see Chapter 3.4 for the order codes.
-  You can not power the router via the ETH2 ports on the SWITCH router version. The PoE PD is available on the ETH0 and ETH1 ports only.
-  The *IEEE 802.3af/PoE* (Type 1) and *IEEE 802.3at/PoE+* (Type 2) standards are supported. The device is Mode B compliant.
-  You can use the `pse` command to control the PoE functionality; see the [Commands and Scripts](#) application note.

Based on the model configuration, the PoE PSE or PoE PD feature can be supported for both Ethernet ports (ETH0 and ETH1).

The PoE PSE version allows the router to power other devices over the Ethernet. The PoE PD version enables the router to be powered by another PoE PSE device over the Ethernet.

PoE PD

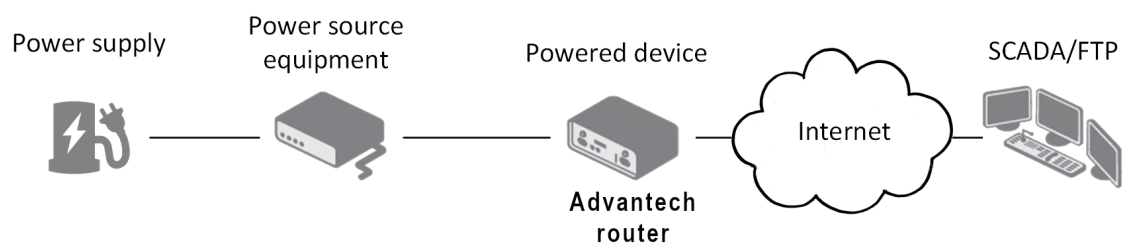

Figure 36: PoE PD usage

The PoE PD parameters can be found in Chapter 5.7. The POE LED on the front panel of the router lights up green when voltage is present on an Ethernet port, so the user knows the router can be PoE powered. You can still power the router with this connector even if the router is powered with PoE (in PoE PD version), but the input voltage must be higher than 15 V DC. If the input voltage is lower than 15 V DC and the PoE voltage is present (POE LED green on), the router will still be powered from the Ethernet connector via PoE.

PoE PSE

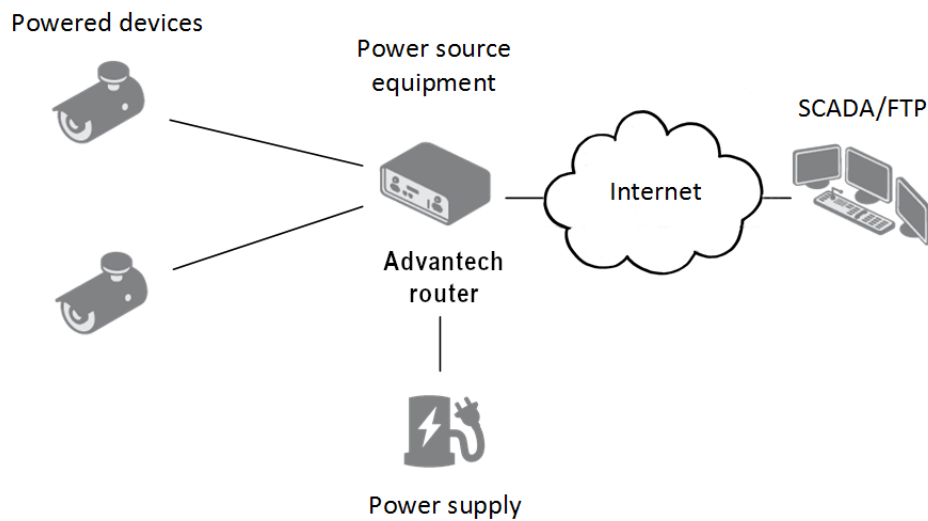

Figure 37: PoE PSE usage

! The power supply used with the PoE PSE router has to provide voltage from 44 to 57 V DC and the output power has to be at least 65 W for full PoE+ use (Class 4) in both Ethernet ports (ETH0 and ETH1).

The PoE PSE parameters can be found in Chapter 5.7. The PoE state is indicated by the POE LED on the front panel of the router, see Chap. 3.9.1. When sufficient voltage (44 to 57 V) and power is available is indicated by the green light. A yellow POE LED indicates insufficient power or voltage through the PWR connector. When a device is being powered from the router, the POE LED will be blinking green. Yellow blinking is shown for an overload (the powered device is using too much power) or a short circuit (incorrect wiring of the cable or of the device without PoE support).

You can enable or disable the PoE PSE feature separately on the ETH0 and ETH1 ports via the Web interface of the router. This can be found in the LAN configuration pages (*Primary* for ETH0, *Secondary* for ETH1). When PoE PSE is enabled, you can find the current, voltage, power and power class information on the *General* page of the router's Web interface; see the *Configuration manual* [1].

3.9.10 USB Port

Panel socket USB-A.

Pin	Signal mark	Description	Data flow direction
1	+5 V	Positive pole of 5 V DC supply voltage, 0.5 A	
2	USB data -	USB data signal – negative pole	Input/Output
3	USB data +	USB data signal – positive pole	Input/Output
4	GND	Negative pole of DC supply voltage	

Table 17: Connection of USB connector



Figure 38: USB connector



The USB port is disabled on overload to prevent its damage (connected device is trying to get too high current). The port is enabled again after the reboot of the router.

Mounting USB Flash Drive to the System

It is necessary to mount the USB flash drive to be able to access it in the system of the router. Follow these steps to mount the drive:

- Use the `dmesg` command to see the list of recently connected devices.
- In the output of the command find out the entry for the microSD card, for example:

```
sda: sda1
```
- To mount the card to to `mnt` directory, use the `mount` command:

```
mount /dev/sda1 /mnt
```



For more information about the commands for creating, mounting, checking and unmounting a file system on a USB Flash Drive, see the application note for [Ext4 Filesystem Utilities](#) router app.

3.9.11 I/O Port

Panel socket 6-pin.

Pin	Signal mark	Description
1	IN0	Binary input 0
2	IN0	Binary input 0
3	IN1	Binary input 1
4	IN1	Binary input 1
5	OUT	Binary output
6	OUT	Binary output

Table 18: Connection of I/O port

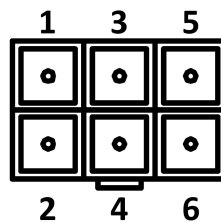

Figure 39: I/O connector

The I/O user Interface is designed for the processing of binary input and control (setting) of binary output. Binary output is open in the default configuration. The isolation strength is 1.5kV. The pins are isolated from each other with the same strength.

The input circuits are bipolar and allow connection as needed with common plus or minus (according to the connection of an external voltage).

Binary inputs

- Characteristics of inputs:

Logical 0 / 1*	Voltage	Current	Web interface status
log. 1 max	3 V	0.4 mA	Off
log. 0 min	5 V	0.7 mA	On
log. 0 type	12 V	2 mA	On
log. 0 max	60 V	7 mA	On

Table 19: Characteristics of inputs

* The binary input status in the Shell is returned via `io get bin0` or `io get bin1`.

Binary output

- Binary output parameters:
 - 60 V AC / 300 mA
 - 60 V DC / 300 mA
- The current of the binary output is limited by a resettable fuse (300 mA).

Binary inputs and output connections

Binary inputs and output connections example:

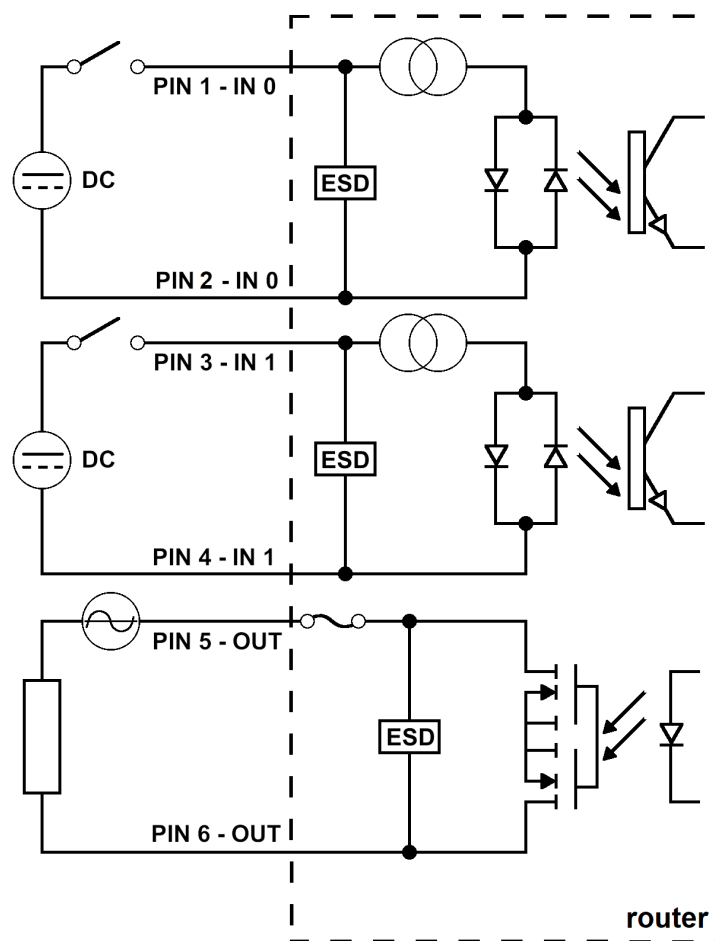

Figure 40: Binary connection

3.9.12 Reset

When the *PWR* LED starts flashing on the front panel, it is possible to restore the default configuration of the router by pressing the *RST* button on the rear panel. After pressing this button the default configuration will be restored and the router will reboot (after which the green LED will be on).

i It is necessary to use a narrow screwdriver or any other small tool to press the *RST* button.

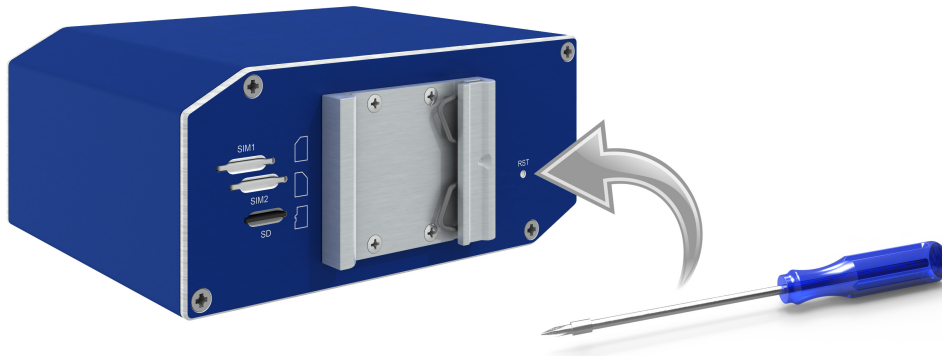

Figure 41: Router reset

! Before resetting the router, it is recommended to back up the router configuration settings (see *Configuration manual*) because resetting the router will return all configuration settings to their default states.

It is important to distinguish between the router reset and reboot.

Action	Router behavior	Invoking events
Reboot	Turns off and then turns on the router	Disconnect and reconnect the power, press the <i>Reboot</i> button in the web configuration
Reset	Restores the default configuration and reboots the router	Press the <i>RST</i> button

Table 20: Description of router reset and restart

3.10 Interfaces Description

Besides the basic version of SmartFlex router there are available versions with one of the following interfaces:

- SWITCH interface
- RS232-RS485/422 interface
- RS232-RS485-ETH interface



Note that only the Advantech service center can do the jumpering inside the router.

3.10.1 SWITCH Interface

The three LAN ports of the SWITCH interface for SmartFlex routers (RJ45 connectors for connecting Ethernet devices) act as a typical switch device. This means that the router reads Ethernet frames (data packets on an Ethernet link) from any port on the SWITCH interface and transmits them on other ports of the SWITCH interface. Each port can transmit frames independently on the other ports. State indication is displayed separately on each connector. These router versions comply with the standards and temperature ranges stated in Chap. efchap:BasicParams except for having a lower maximum operating temperature, which is +70 °C.

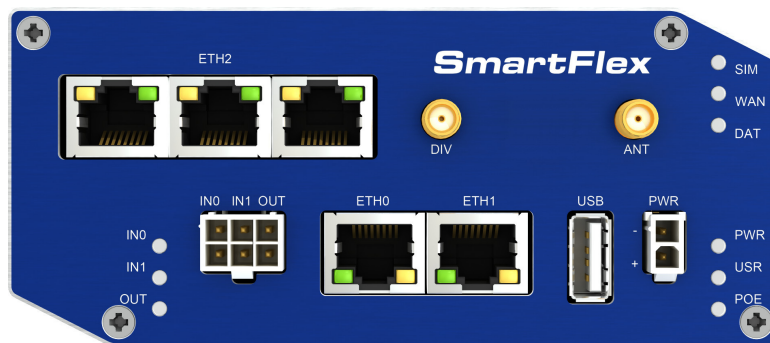

Figure 42: Version with SWITCH board

State indication of the interface:

Description of indication		
Green LED	On	Selected 100 Mbps
	Off	Selected 10 Mbps
Yellow LED	On	The network cable is connected
	Blinking	Data transmission
	Off	The network cable is not connected

Table 21: State indication of the SWITCH interface

Technical specification of Ethernet IEEE 802.3:

Ethernet interface, IEEE 802.3 standard	
Maximum data rate	100 Mbps
Max. total cable length (300 Bd, 200 nF/km)	100 m

Table 22: SWITCH interface parameters

3.10.2 RS232-RS485/422 Interface

These interfaces are physically connected through the 5-pin and 4-pin terminal block connectors. The insulation strength is up to 2.5 kV. **Attention, connectors are not isolated from each other!** No state indication is displayed for this interface. These router versions comply with the standards and temperature ranges stated in Chap. efchap:BasicParams.

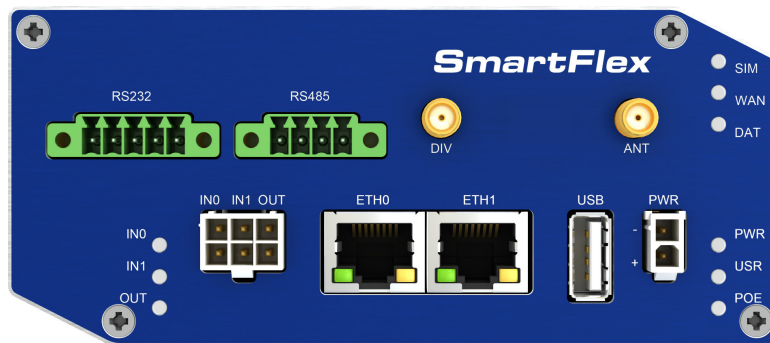

Figure 43: Version with RS232-RS485/422 interface



When connecting counterpart terminal block connectors (included in package with the router), use cables with nominal cross section 0.2 to 1.0 square mm (30 to 16 AWG). Recommended stripping length is 5 mm. For M2 captive screws the screw driver 0.5 x 3 mm is recommended. Tighten the screws with 0.3 Nm torque.

Connection of RS232 connector:

Pin	Signal	Description	Direction
1	CTS	Clear To Send	Output
2	RTS	Request To Send	Input
3	GND	Signal ground*	—
4	RXD	Receive Data	Input
5	TXD	Transmit Data	Output

Table 23: Connection of RS232 connector

* Both connectors (RS232 and RS485/422) have a common ground connection.

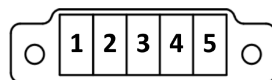

Figure 44: RS232 connector

Connection of RS485 connector:

Pin	Signal	Description	Direction
1	TxRx+	RS485 B (+)	Input/Output
2	TxRx-	RS485 A (-)	Input/Output
3	TxRx+	RS485 B (+)	Input/Output
4	TxRx-	RS485 A (-)	Input/Output

Table 24: Connection of RS485 connector

Connection of RS422 connector:

Pin	Signal	Description	Direction
1	RxD+	RS422 (+)	Output
2	RxD-	RS422 (-)	Output
3	TxD+	RS422 (+)	Input
4	TxD-	RS422 (-)	Input

Table 25: Connection of RS422 connector

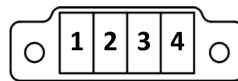

Figure 45: RS485/422 connector

The selection of either RS485 or RS422 can be performed by using jumpers on the board. Three jumpers are required for the RS485 interface or one jumper for the RS422 interface. **The default configuration is RS485 with termination off.**

Technical specification of RS232 and RS485 bus:

RS232 and RS485 interface	
Max. operating RS232 bus current	15 mA
Max. number of devices on RS485 bus	32
Max. output current on RS485 bus	60 mA
Max. data rate	230400 bps on RS232 230400 bps on RS485
Max. total cable length (300 Bd, 200 nF/km)	RS232 20 m, RS485 1200 m

Table 26: Technical specification of RS232 and RS485



The termination resistor can be activated directly on the port board using a jumper (termination resistor is part of the port board).

3.10.3 RS232-RS485-ETH Interface

This interface board includes a panel RJ45 connector for Ethernet connection (ETH2 in the figure), and four-pin and three-pin terminal block connectors for RS232 and RS485 connection. The insulation strength is up to 2.5 kV between the ETH2 and RS485 interfaces and from the rest of the router, too. The RS232 interface is not insulated from the rest of the router. State indication is displayed by LEDs above each connector, as shown in the table below. These router versions comply with the standards and temperature ranges stated in Chap. efchap:BasicParams.

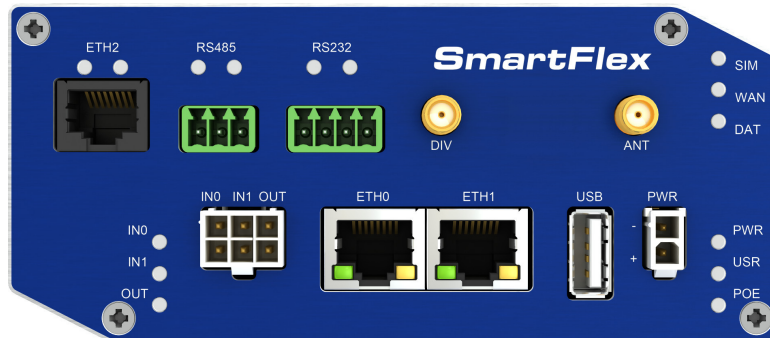

Figure 46: Version with RS232-RS485-ETH interface

Connection of ETH connector:

Pin	Signal	Description	Direction
1	TXD+	Transmit Data – positive pole	Input/Output
2	TXD-	Transmit Data – negative pole	Input/Output
3	RXD+	Receive Data – positive pole	Input/Output
4	—	—	—
5	—	—	—
6	RXD-	Receive Data – negative pole	Input/Output
7	—	—	—
8	—	—	—

Table 27: Connections of the Ethernet Connector

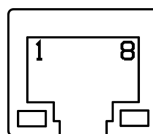

Figure 47: Ethernet connector



When connecting counterpart terminal block connectors (included in package with the router), use cables with nominal cross section 0.2 to 1.0 square mm (30 to 16 AWG). Recommended stripping length is 5 mm. For M2 captive screws the screw driver 0.5 x 3 mm is recommended. Tighten the screws with 0.3 Nm torque.

Connection of RS485 connector:

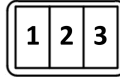

Figure 48: RS485 connector

Pin	Signal	Description	Direction
1	GND	Signal ground*	—
2	TxRx+	RS485 B(+)	Input/Output
3	TxRx-	RS485 A(-)	Input/Output

Table 28: Connections of Terminal Block Connector RS485

* *Signal ground is isolated from the router's ground.*



The termination resistor can be activated directly on the port board using a jumper (termination resistor is part of the port board).

Connection of RS232 connector:

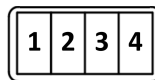

Figure 49: RS232 connector

Pin	Signal	Description	Direction
1	AUX	+5 V/500 mA	—
2	GND	Signal ground*	—
3	RXD	Receive Data	Input
4	TXD	Transmit Data	Output

Table 29: Connections of Terminal Block Connector RS232

* *Common with router's signal ground.*

State indication of the interface:

Description of indication		
ETH2 – green LED	On	Selected 100 Mbps
	Off	Selected 10 Mbps
ETH2 – Yellow LED	On	The network cable is connected
	Blinking	Data transmission
	Off	The network cable is not connected
RS485, RS232 – green LED		Indicates Receive data
RS485, RS232 – yellow LED		Indicates Transmit data

Table 30: State indication of the RS232-RS485-ETH interface

Technical specification of RS232, RS485 bus and Ethernet IEEE 802.3:

ETH2, RS485 and RS232 interface	
Max. operating RS232 bus current	15 mA
Max. number of devices on RS485 bus	32
Max. output current on RS485 bus	60 mA
Max. data rate	230400 bps on RS232 230400 bps on RS485 100 Mbps on ETH2
Max. total cable length (300 Bd, 200 nF/km)	RS232 20 m RS485 1200 m ETH2 100 m

Table 31: Technical specification of RS232, RS485 and Ethernet

4. First Use

4.1 Connecting the router before first use

Before putting the router into operation it is necessary to connect all of the components that are required to run your applications. Don't forget to insert a SIM card.



The router can not operate without a connected antenna, SIM card and power supply. If the antenna is not connected, the router may be damaged.

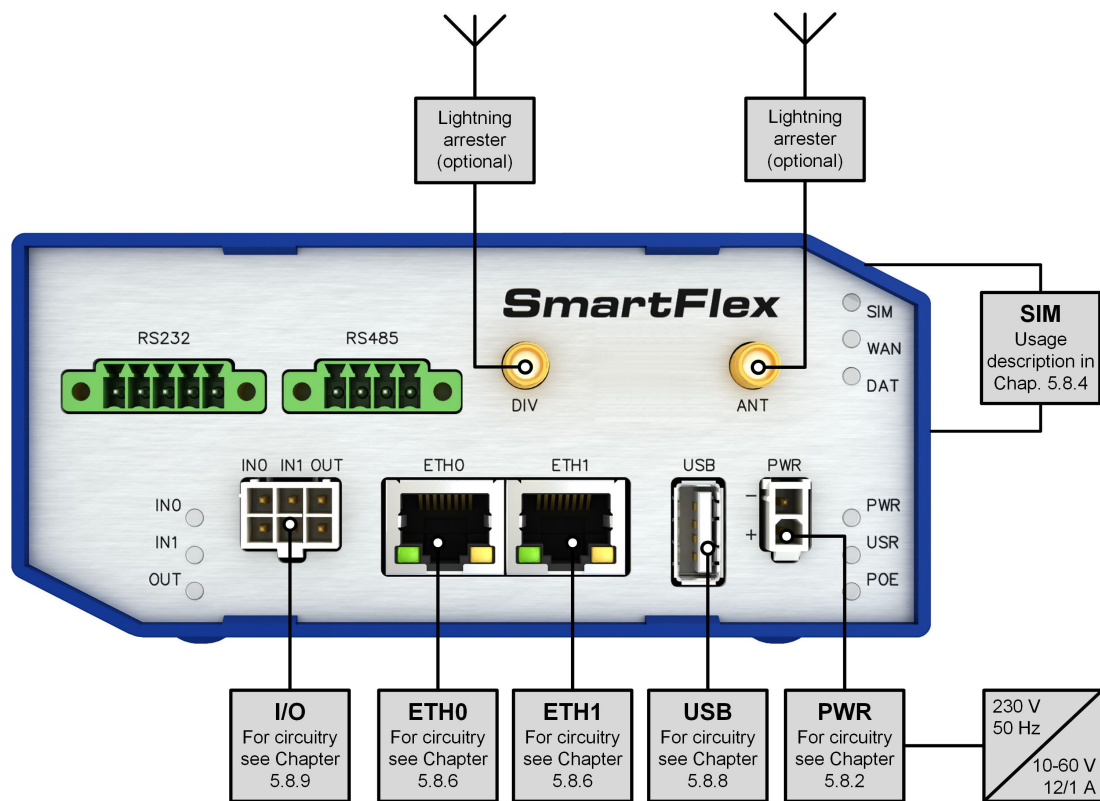

Figure 50: Router connection

4.2 Start

The router will start when a power supply is connected to the router. By default, the router will automatically start to log on to the default APN. The DHCP server will start to assign addresses for devices connected through the Ethernet port ETH0. Router's behavior can be changed via the web interface. This is described in detail in the *Configuration manual for SmartFlex routers*.

4.3 Configuration



If no SIM card is inserted in the router, it is not possible for the router to operate. Any inserted SIM card must have active data transmission.

4.3.1 Configuration by web browser

For status monitoring, configuration and administration of the router a web interface is available which can be accessed by entering the IP address of the router into the web browser. The default IP address of the router is 192.168.1.1. **Attention, it is necessary to use HTTPS protocol for secure communication over a network!**

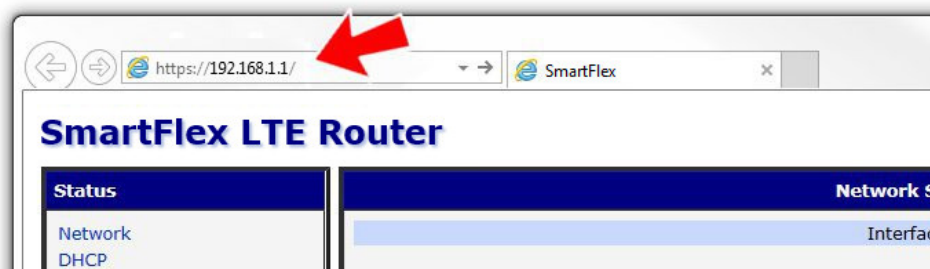

Figure 51: Entering the IP address of the router

By default, configuration may be performed only by the user "root". The default password is printed on the router's label.¹ Change the default password as soon as possible!



All routers have the *WebAccess/DMP* client pre-installed by default. The activated client periodically uploads router identifiers and configuration to the *WebAccess/DMP* server. See the configuration manual [1], chapter *Basic Information* → *WebAccess/DMP Configuration*, for more information.

Figure 52: Entering login information

After successfully entering login information, the user will have access to the router web interface via their browser.

¹If the router's label does not contain a unique password, use the password "root".

Status	General Status
General	Mobile Connection
Mobile WAN	SIM Card : Primary
WiFi	IP Address : 10.0.6.239
WiFi Scan	Rx Data : 1.0 KB
Network	Tx Data : 3.3 KB
DHCP	Uptime : 0 days, 0 hours, 1 minute
IPsec	> More Information <
DynDNS	Primary LAN
System Log	IP Address : 192.168.1.1 / 255.255.255.0
	MAC Address : 7C:66:9D:35:8B:74
	Rx Data : 165.3 KB
	Tx Data : 431.7 KB
	> More Information <
	Secondary LAN
	IP Address : 192.168.2.1 / 255.255.255.0
	MAC Address : 7C:66:9D:35:8B:76
	Rx Data : 1.1 KB
	Tx Data : 7.9 KB
	> More Information <
	Tertiary LAN
	IP Address : 192.168.3.1 / 255.255.255.0
	MAC Address : 00:80:0F:11:70:00
	Rx Data : 0 B
	Tx Data : 0 B
	> More Information <
	WiFi
	IP Address : 192.168.4.1 / 255.255.255.0
	MAC Address : 34:81:F7:11:2A:84
	Rx Data : 0 B
	Tx Data : 0 B
	> More Information <
	Peripheral Ports
	Expansion Port 1 : Ethernet Switch
	Expansion Port 2 : None
	Binary Input 1 : Off
	Binary Input 2 : Off
	Binary Output : Off
	System Information
	Firmware Version : 0.1.RC2 (2014-10-07) BETA
	Serial Number : N/A
	Profile : Standard
	Supply Voltage : 12.0 V
	Temperature : 45 °C
	Time : 2000-01-01 01:09:29
	Uptime : 0 days, 0 hours, 4 minutes

Figure 53: Router web interface



A detailed description of the router settings in the Web interface can be found in the *Configuration manual for SmartFlex routers*.

5. Technical Parameters

5.1 Basic parameters

SmartFlex Router		
Temperature range	Operating Storage	-40 °C to +70 °C (-40 °F to +158 °F) -40 °C to +85 °C (-40 °F to +185 °F)
Cold start	-15 °C	Data transfers via mobile network are available immediately
	-20 °C	Data transfers via mobile network are available approximately in five minutes after the start of the router. Everything else is functional immediately.
Humidity	Operating Storage	0 to 95 % relative humidity non condensing 0 to 95 % relative humidity non condensing
Altitude	Operating	2000 m / 70 kPa
Degree of protection		IP30
Supply voltage		10 to 60 V DC
Battery for RTC		CR1225
Consumption	Idle	2.5 W
	Average	4 W
	Peak	11 W
	Sleep mode	10 mW
Dimensions		55 x 97 x 125 mm (2.17" x 3.82" x 4.92") (DIN 35 mm, EN 60715)
Weight	Plastic box	approximately 170 g (0.37 lbs) (depends on interface)
	Metal box	approximately 380 g (0,83 lbs) (depends on interface)
Antenna connectors		2x SMA – 50 Ω 1x R-SMA – 50 Ω (je-li osazen WiFi modul)
User interface	2x ETH USB I/O Micro SD	Ethernet (10/100 Mbps) USB 2.0 6-pin panel socket SDHC, SDXC

Table 32: Basic parameters

5.2 Standards and regulations

The router complies with the following standards and regulations.

Standards and regulations	
Radio	EN 301 511 , EN 301 908-1, EN 301 908-2, EN 301 908-13, EN 303 413, EN 301 893, EN 300 328, FCC part 22H, FCC part 24E, FCC part 27, FCC part 90R, PTCRB
EMC	ETSI EN 301 489-1, ETSI EN 301 489-17, ETSI EN 301 489-19, ETSI EN 301 489-52, EN 55032, EN 61000-4-2, EN IEC 61000-4-3, EN 61000-4-4, EN 61000-4-5, EN 61000-4-6, IEC 61000-6-2, IEC 61000-6-3, FCC Part 15 Subpart B, ICES-003 Issue 6
Safety	EN IEC 62368-1, EN IEC 62311, UL E487720
Carrier approvals	AT&T, T-Mobile US, Verizon
National	CE, UKCA, FCC, IC, TELEC
Environmental	REACH, RoHS3 and WEEE compliant

Table 33: Standards and regulations

5.3 Type tests and environmental conditions

Phenomena	Test	Description	Test levels
ESD	EN 61000-4-2	Enclosure contact Enclosure air	± 6 kV ± 8 kV
RF field AM modulated	EN IEC 61000-4-3	Enclosure	10 V/m (80 – 1000 MHz) 10 V/m (1000 – 6000 MHz)
Fast transient	EN 61000-4-4	Signal ports Power ports Ethernet ports	± 1 kV ± 1 kV ± 1 kV
Surge	EN 61000-4-5	Ethernet ports Power ports I/O ports	± 1 kV ± 1 kV ± 1 kV
RF conducted	EN 61000-4-6	All ports	10 V/m (0,15 – 80 MHz)
Radiated emission	EN 55032	Enclosure	Class B
Conducted emission	EN 55032	DC power ports Ethernet ports	Class B Class B
Degrees of protection provided by enclosures	EN 60529	IP30	
Dry heat	EN 60068-2-2	storage +85 °C, operation +75 °C	
Cold	EN 60068-2-1	storage -40 °C	
Damp heat	EN 60068-2-30	+55 °C / +25 °C, rel. humidity 95%, 6 h - 6 h	
Shock	EN 60068-2-14	-40 °C/+75 °C, 3h/3h, 2 cycles, 3 K/min	

Table 34: Type tests and environmental conditions

5.4 Technical parameters of cellular module

Technical parameters of cellular module	
LTE parameters	<p>LTE: LTE Cat 4, 3GPP Rel. 11</p> <p>FDD frequencies: B12 & B13 & B28 (700 MHz), B20 (800 MHz), B26 (850 MHz), B19 (850 MHz), B18 (850 MHz), B5 (850 MHz), B8 (900 MHz), B4 (1700 MHz), B3 (1800 MHz), B2 & B25 (1900 MHz), B1 (2100 MHz), B7 (2600 MHz)</p> <p>FDD bit rates: up to 150 Mbps (DL), 50 Mbps (UL)</p> <p>TDD frequencies: B39 (1900 MHz), B40 (2300 MHz), B41 (2500 MHz), B38 (2600 MHz)</p> <p>TDD bit rates: up to 130 Mbps (DL), 30 Mbps (UL)</p> <p>Maximum aggregated bandwidth: 20 MHz</p>
UMTS parameters	<p>UMTS: 3GPP Release 8</p> <p>Supported frequencies: B19 (800 MHz), B6 (800 MHz), B5 (850 MHz), B8 (900 MHz), B4 (1700 MHz), B2 (1900 MHz), B1 (2100 MHz)</p> <p>DC-HSDPA bit rates: Max. 42 Mbps (DL)</p> <p>HSUPA bit rates: Max. 5.76 Mbps (UL)</p> <p>WCDMA bit rates: 384 kbps (DL) / 384 kbps (UL)</p>
EDGE parameters	<p>Supported frequencies: 850 MHz, 900 MHz, 1800 MHz, 1900 MHz</p> <p>Data throughput: 296 kbps (DL) / 236.8 kbps (UL)</p>
GPRS parameters	<p>Supported frequencies: 850 MHz, 900 MHz, 1800 MHz, 1900 MHz</p> <p>Data throughput: 107 kbps (DL) / 85.6 kbps (UL)</p>

Table 35: Technical parameters of cellular module

Antenna Requirements

- VSWR – <2:1 (Antenna input impedance response as function of frequency. This shows the antenna resonances and its bandwidth).
- SMA – 50 Ω
- For good diversity performance, the primary and secondary antennas should have different polarizations.

5.5 Technical parameters of WiFi

WiFi	
Antenna connector	R-SMA – 50 Ω
Supported WiFi band	2.4 GHz, 5 GHz
Standards	802.11a, 802.11b, 802.11g, 802.11n
2.4 GHz supported channels	1, 2, 3, 4, 5, 6, 7, 8, 9, 10, 11, 12, 13
5 GHz supported channels ¹	36, 38, 40, 42, 44, 46, 48, 52, 56, 60, 64, 100, 104, 108, 112, 116, 120, 124, 128, 132, 136, 140, 149, 153, 157, 161, 165
Type of device	Access point, station
Max. clients in AP mode	10
WiFi TX Output Power	17,3 dBm
WiFi RX Sensitivity	-96,3 dBm
AP maximum users	10 users (WiFi module supports multi-role operation in STA and AP. Multi-role does not affect the maximum number of users).

Table 36: Technical parameters of WiFi

5.6 Technical parameters of I/O port

- Characteristics of inputs:

Logical 0 / 1*	Voltage	Current	Web interface status
log. 1 max	3 V	0.4 mA	Off
log. 0 min	5 V	0.7 mA	On
log. 0 type	12 V	2 mA	On
log. 0 max	60 V	7 mA	On

Table 37: Characteristics of inputs

* The binary input status in the Shell is returned via `io get bin0` or `io get bin1`.

- Binary output parameters:
 - 60 V AC / 300 mA
 - 60 V DC / 300 mA

¹Supported channels depends on selected Country Code.

5.7 Technical Parameters of Power over Ethernet (PoE)

Standards IEEE 802.3at-2009 (PoE+) and IEEE 802.3af-2003 (PoE) are supported. Cabling needed is Category 5, up to 12.5 Ω . It is possible to use a passive PoE injector.

PoE PSE parameters	
Power supply needed	44 – 57 V, 65 W
Power available	2x 25.50 W (ETH0, ETH1)

Table 38: PoE PSE parameters

5.8 Other Technical Parameters

Parameter	Description
CPU power	2 DMIPS per MHz
Flash memory	256 MB
RAM	512 MB
M-RAM	128 kB

Table 39: Other technical parameters

Appendix A: Troubleshooting

If you cannot connect to the router from your PC, your network card may be configured in such a way that it is not possible to connect to the router. Take one or more of the following steps in order to solve the problem:

- Make sure your PC's network card is configured to obtain the IP address from the DHCP server (by default the DHCP server is running in the router).
- Connect the router to the PC via Switch.
- Connect the router to the PC, start the router first and then start the PC after the router's initialization.

Ethernet connection fails or is not establishing.

- It is possible to turn auto negotiation off and set a rate and duplex manually on the Ethernet interface of the router. Available on "LAN Configuration" page in the router.

Mobile WAN connection fails.

- Check the signal power ("Mobile WAN status" page). If the signal power is weak, you will have to use a better antenna. If the neighbouring cells have a similar signal strength, you will need to use a directional antenna. For proper operation, the signal levels have to be good.
- Try to enable automatic ping from the router, which will check the connection when there are no data running and in the case of a failed ping, restart the connection. This can be done on the "Mobile WAN Configuration" page in the router in the "Check connection" section. "Enable + bind" option is to ensure the ping goes always through Mobile WAN network interface.

Mobile WAN connection cannot be established.

- Check the "Mobile WAN Configuration" – APN, name, password and IP address (all can be blank).
- Try to enter the SIM card PIN – verify that the SIM card has the PIN code entered. Available on "Unlock SIM Card" page in the "Administration" section.
- In a private APN it is not recommended to get the DNS settings from operator (on "Mobile WAN" page)
- Go to "System Log" page in "Status" section and observe where the error occurs.

I cannot connect from the Internet to the device behind the router. I have NAT enabled.

- The device's gateway has to be configured so it points to the router.

I can't access my Web server placed behind the router over NAT.

- The remote HTTP access to the router has to be disabled on "NAT Configuration" page in the router. Also enable "Send all remaining incoming packets to default server" feature and fill in the IP address of your Web server. On the Web server, the default gateway has to be the IP address of the router.

DynDNS doesn't work.

- With private APN this will not work.

- If the same IP address is recorded in your canonic name as a dynamically assigned address, it means that the operator is using NAT or a firewall.
- You can verify NAT using ping to your server with static address and then compare with router's IP address.
- You can verify a Firewall by accessing remotely to the router's Web interface.
- The operator may not provide the address of DNS server and without DNS server's address it is impossible to connect to the dyndns.org server. The following messages will be shown in the System Log:
 - DynDNS daemon started
 - Error resolving hostname: no such file or directory
 - Connect to DynDNS server failed

 **L2TP or IPSec isn't establishing.**

- Check the "System Log" page for error messages.

 **IPSec tunnel establishes but the communication does not run.**

- Probably there are bad routing rules defined in the connected devices, or the default gateway.

 **I switched the router to offline mode by SMS message, but the router is in online mode after reboot.**

- SMS messages do not change the router configuration. They remain in effect only until the router is rebooted.

Serial communication is not working.

- Verify that the router model supports serial communications. Also verify the serial communication settings. To do so, open the router's configuration menu via the web browser, select the appropriate "Expansion Port" from "Configuration" part of the menu and verify the settings.

Is the router Cisco compatible? Can I use the Cisco configuration?

- No, the Firmware in the router (ICR-OS) is based on Linux with BusyBox. Thus the Cisco configuration cannot be used. But network connections are defined by standards so connecting the router to the Cisco or other networking devices is possible and will be compatible.

FTP or SFTP does not work

- FTP will work on v2 routers only. You can use SFTP on all routers to transfer files to/from the router. If having troubles with FTP on v2 routers, make sure you have FTP enabled: "Configuration" section, "Services", "FTP". Then you can connect with any client on port 21 with name and password same as for the Web interface. If having troubles with SFTP, make sure you have SSH enabled: "Configuration" section, "Services", "SSH". Then you can connect with any client on port 22 with name and password same as for the Web interface.

How can I connect to the router's command line? (SSH, Telnet)

- You can use SSH on all routers or Telnet on v2 routers only. SSH is enabled by default, but you can verify in Web interface in "Configuration" section, "Services", "SSH". Then connect with any SSH client on port 22 of the router. User and password is the same as for the Web interface. Telnet on v2 routers can be enabled here: "Configuration" section, "Services", "Telnet".

Appendix B: Customer Support

Customer Support for Europe

Advantech Czech s.r.o.

Sokolska 71
562 04, Usti nad Orlici
Czech Republic

Phone: +353 91 792444
Fax: +353 91 792445
E-mail: iiotcustomerservice@advantech.eu
Web: www.advantech.com

Customer Support for NAM

Advantech B+B SmartWorx

707 Dayton Road
Ottawa, IL 61350 USA

Phone: +1-800-346-3119 (Monday – Friday, 7 a.m. to 5:30 p.m. CST)
Fax: +1-815-433-5109
E-mail: support.iiot.ana@advantech.com
Web: www.advantech.com

Customer Support for Asia

Phone: +886-2-2792-7818 #1299 (Monday – Friday, 9 a.m. to 5:30 p.m. UTC+8)
Fax: +886-2-2794-7327
E-mail: icg.support@advantech.com.tw
Web: www.advantech.com

Appendix C: Regulatory & Safety Information

Safety Notices



Please, observe the following instructions:

- The router must adhere to all relevant international and national laws, including any specific restrictions governing its use in designated applications and environments.
- To prevent potential injury and appliance damage, ensure compliance with regulations by using only authorized accessories. Unauthorized modifications or use of unapproved accessories could damage the router, violate regulations, and void the warranty.
- Do not attempt to open the router.
- Before handling the SIM card, turn off the router and disconnect it from the power supply.
- **Caution!** This equipment is not suitable for use in areas with children. Small children could swallow the SIM card.
- Ensure the power supply does not exceed 48 V DC maximum.
- Avoid exposing the router to extreme ambient conditions. Safeguard it against dust, moisture, and high temperatures.
- Only deploy routers with appropriate certification and labeling in environments containing flammable or explosive materials, such as gas stations, chemical plants, or areas involving explosives. Users must observe restrictions pertaining to radio device usage in such settings.
- When traveling by plane, switch off the router. Using it onboard could jeopardize flight operations, disrupt mobile networks, and potentially violate regulations. Non-compliance may result in telephone service suspension, cancellation, or legal repercussions.
- Exercise heightened caution when operating the router near personal medical devices like cardiac pacemakers or hearing aids.
- The router may cause interference when operated in close proximity to TV sets, radio receivers, or personal computers.
- It's advisable to create a suitable backup of all critical settings stored in the device's memory.



Product Disposal Instructions

The WEEE (Waste Electrical and Electronic Equipment: 2012/19/EU) directive was introduced to ensure that electrical/electronic products are recycled using the best available recovery techniques to minimize the environmental impact. This product contains high quality materials and components which can be recycled. At the end of its life this product **MUST NOT** be mixed with other commercial waste for disposal. The device contains a battery. Remove the battery from the device before disposal. The battery in the device needs to be disposed of apart accordingly. Check the terms and conditions of your supplier for disposal information.

Appendix D: Related Documents

[1] [Configuration Manual for SmartFlex Routers](#)



[EP] Product-related documents and applications can be obtained on **Engineering Portal** at <https://icr.advantech.com/download> address.



We, Advantech Czech s.r.o., declare that the radio equipment narrated in this user's manual complies with Radio Equipment Regulations 2017 (**S.I. 2017 No. 1206**).



We, Advantech Czech s.r.o., declare that the radio equipment narrated in this user's manual complies with Directive **2014/53/EU**.

The full text of the EU Declaration of Conformity is available at the following internet address:
icr.advantech.com/eudoc