

Configuration Manual

SmartMotion Family

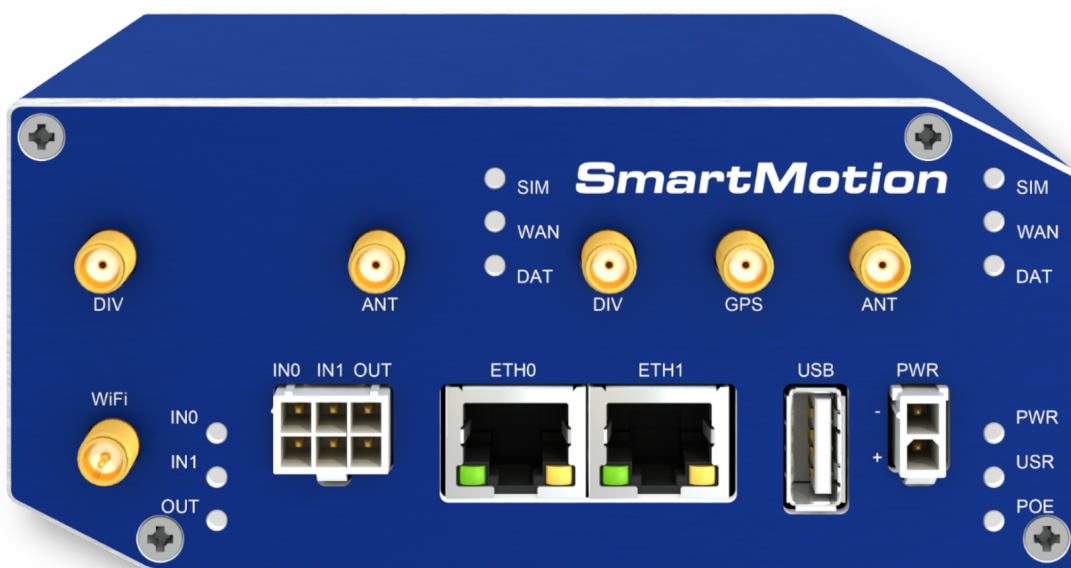

© 2025 Advantech Czech s.r.o. No part of this publication may be reproduced or transmitted in any form or by any means, electronic or mechanical, including photography, recording, or any information storage and retrieval system without written consent. Information in this manual is subject to change without notice, and it does not represent a commitment on the part of Advantech.

Advantech Czech s.r.o. shall not be liable for incidental or consequential damages resulting from the furnishing, performance, or use of this manual.

All brand names used in this manual are the registered trademarks of their respective owners. The use of trademarks or other designations in this publication is for reference purposes only and does not constitute an endorsement by the trademark holder.

Used symbols



Danger – Information regarding user safety or potential damage to the router.



Attention – Problems that can arise in specific situations.



Information – Useful tips or information of special interest.

Firmware Version

This manual is compatible with firmware version 6.5.2 (March 3, 2025).



Contents

1. Getting Started	1
1.1 Document Content	1
1.2 Configuration Environments	2
1.2.1 Web Interface Initial Setup	3
1.2.2 Remote Management Platform	6
1.3 Device	7
1.3.1 Persistent Storage	7
1.3.2 Reset	7
2. Status	8
2.1 General	8
2.1.1 Mobile Connection	8
2.1.2 Ethernet	9
2.1.3 WiFi	9
2.1.4 Peripheral Ports	10
2.1.5 Security Information	10
2.1.6 System Information	11
2.2 Mobile WAN	12
2.3 WiFi	16
2.4 WiFi Scan	17
2.5 Network	19
2.5.1 Connections	22
2.6 DHCP	23
2.7 IPsec	24
2.8 WireGuard	25
2.9 DynDNS	26
2.10 System Log	27
3. Configuration	28
3.1 Ethernet	28
3.1.1 DHCP Server	31
3.1.2 IPv6 Prefix Delegation	32
3.1.3 802.1X Authentication to RADIUS Server	33
3.1.4 LAN Configuration Examples	35
3.2 VLAN	41
3.3 VRRP	43
3.3.1 VRRP Usage Example	44
3.4 Mobile WAN Configuration	45
3.5 1st and 2nd Mobile WAN Configuration	45
3.5.1 Connection to Mobile Network	45
3.5.2 DNS Address Configuration	47
3.5.3 Check Connection to Mobile Network	47
3.5.4 Check Connection Example	48
3.5.5 Data Limit Configuration	49
3.5.6 Switch between SIM Cards Configuration	50

3.5.7	Examples of SIM Card Switching Configuration	53
3.6	Module Switching Configuration	55
3.6.1	PPPoE Bridge Mode Configuration	57
3.7	PPPoE	58
3.8	WiFi Access Point	60
3.9	WiFi Station	66
3.10	Backup Routes	70
3.10.1	Default Priorities for Backup Routes	70
3.10.2	User Customized Backup Routes	71
3.10.3	Backup Routes Examples	74
3.11	Static Routes	82
3.12	Firewall	83
3.12.1	Example of the IPv4 Firewall Configuration	86
3.12.2	Sites	87
3.13	NAT	88
3.13.1	Examples of NAT Configuration	91
3.14	OpenVPN	93
3.14.1	Example of the OpenVPN Tunnel Configuration in IPv4 Network	97
3.15	IPsec	98
3.15.1	Route-based Configuration Scenarios	98
3.15.2	IPsec Authentication Scenarios	99
3.15.3	Configuration Items Description	100
3.15.4	Basic IPv4 IPsec Tunnel Configuration	105
3.16	WireGuard	106
3.16.1	WireGuard IPv4 Tunnel Configuration Example	108
3.17	GRE	110
3.17.1	Example of the GRE Tunnel Configuration	111
3.18	L2TP	113
3.18.1	Example of the L2TP Tunnel Configuration	115
3.19	PPTP	116
3.19.1	Example of the PPTP Tunnel Configuration	118
3.20	Services	119
3.20.1	Authentication	119
3.20.2	DynDNS	123
3.20.3	FTP	124
3.20.4	HTTP	125
3.20.5	NTP	126
3.20.6	SNMP	127
3.20.7	SMTP	131
3.20.8	SMS	132
3.20.9	SSH	140
3.20.10	Syslog	141
3.20.11	Telnet	144
3.21	USB Port	145
3.21.1	Examples of USB Port Configuration	147
3.22	Scripts	148
3.22.1	Startup Script	148
3.22.2	Example of Startup Script	148
3.22.3	Up/Down Scripts	149
3.22.4	Example of IPv6 Up/Down Script	149

3.23 Automatic Update	150
3.23.1 Example of Automatic Update	152
3.23.2 Example of Automatic Update Based on MAC	153
4. Customization	154
4.1 Router Apps	154
4.2 Settings	156
5. Administration	157
5.1 Manage Users	157
5.2 Modify User	159
5.2.1 Two-Factor Authentication	160
5.2.2 Passwordless Console Login	163
5.2.3 Expired Password	165
5.3 Change Profile	166
5.4 Set Date and Time	167
5.5 Set SMS Service Center Address	168
5.6 Unlock SIM Card	168
5.7 Unblock SIM Card	169
5.8 Send SMS	170
5.9 Backup Configuration	171
5.10 Restore Configuration	172
5.11 Update Firmware	173
5.12 Reboot	174
5.13 Logout	174
6. Typical Situations	175
6.1 Access to the Internet from LAN	175
6.2 Backup Access to the Internet from LAN	177
6.3 Secure Networks Interconnection or Using VPN	181
Appendix A: Open Source Software License	183
Appendix B: Glossary and Acronyms	184
Appendix C: Index	189
Appendix D: Related Documents	191

List of Figures

1	Web Configuration GUI	4
2	Mobile WAN status	15
3	WiFi Status	16
4	WiFi Scan Output Example	17
5	Network Status	21
6	Connection List	22
7	DHCP Status	23
8	IPsec Status	24
9	WireGuard Status Page	25
10	DynDNS Status	26
11	System Log	27
12	LAN Configuration Page	28
13	IPv6 Address with Prefix Example	32
14	IEEE 802.1X Functional Diagram	33
15	Network Topology for Example 1	35
16	LAN Configuration for Example 1	36
17	Network Topology for Example 2	37
18	LAN Configuration for Example 2	38
19	Network Topology for Example 3	39
20	LAN Configuration for Example 3	40
21	VLAN Configuration Form	41
22	VRRP Configuration Example Topology	44
23	Main Router Configuration	44
24	Backup Router Configuration	44
25	Switching and configuration pages structure	45
26	Check Connection Example	48
27	1st Mobile WAN Configuration	52
28	Configuration for SIM card switching Example 1	53
29	Configuration for SIM card switching Example 2	54
30	Module Switching Configuration	55
31	PPPoE Configuration	58
32	WiFi Access Point Configuration Page	65
33	WiFi Station Configuration Page	66
34	Backup Routes Configuration Page	73
35	Example #1: GUI Configuration	74
36	Example #1: Topology	74
37	Example #2: GUI Configuration	75
38	Example #2: Topology	75
39	Example #3: GUI Configuration	76
40	Example #3: Topology for <i>Single WAN</i> mode	77
41	Example #3: Topology for <i>Multiple WAN</i> mode	77
42	Example #4: GUI Configuration	78
43	Example #4: Topology	78
44	Example #5: GUI Configuration	79
45	Example #5: Topology	79
46	Example #6: GUI Configuration	80
47	Example #6: Topology	80

48	Example #7: GUI Configuration	81
49	Example #7: Topology	81
50	Static Routes Configuration Page	82
51	IPv6 Default Firewall Configuration	83
52	Topology for the IPv4 Firewall Configuration Example	86
53	IPv4 Firewall Configuration Example	86
54	Firewall Sites Configuration GUI	87
55	NAT IPv4 Configuration Page	89
56	Topology for NAT Configuration Example 1	91
57	NAT Configuration for Example 1	91
58	Topology for NAT Configuration Example 2	92
59	NAT Configuration for Example 2	92
60	OpenVPN tunnel configuration Page	96
61	Topology of OpenVPN Configuration Example	97
62	IPsec Tunnels Configuration Page	100
63	Topology of IPsec Configuration Example	105
64	WireGuard Tunnels Configuration Page	107
65	Topology of WireGuard Configuration Example	108
66	Router A – WireGuard Status Page and Route Table	109
67	Router B – WireGuard Status Page and Route Table	109
68	GRE Tunnel Configuration Page	111
69	Topology of GRE Tunnel Configuration Example	111
70	L2TP Tunnel Configuration Page	113
71	Topology of L2TP Tunnel Configuration Example	115
72	PPTP Tunnel Configuration Page	116
73	Topology of PPTP Tunnel Configuration Example	118
74	Common Configuration Items	119
75	Configuration of RADIUS	121
76	Configuration of TACACS+	122
77	DynDNS Configuration Example	123
78	Configuration of FTP server	124
79	HTTP Configuration Page	125
80	NTP Configuration Page	126
81	OID Basic Structure	128
82	SNMP Configuration Example	129
83	MIB Browser Example	130
84	SMTP Client Configuration Example	131
85	SMS Configuration	132
86	SMS Configuration for Example 1	137
87	SMS Configuration for Example 2	138
88	SMS Configuration for Example 3	139
89	SSH Configuration Page	140
90	Syslog Configuration Page	141
91	Telnet Configuration Page	144
92	USB configuration	146
93	Example 1 – USB port configuration	147
94	Example 2 – USB port configuration	147
95	Example of a Startup Script	148
96	Example of IPv6 Up/Down Script	149
97	Automatic Update	150

98	Example of Automatic Update	152
99	Example of Automatic Update Based on MAC	153
100	Default Router Apps GUI	154
101	Router Apps GUI with Available Online Apps	155
102	Router Apps Settings	156
103	Modify User Page	157
104	Users Administration Form	159
105	Links for Google Authenticator Application	161
106	Links for Authenticator-Extension	161
107	Standard Login	162
108	Verification Code	162
109	SSH Login	162
110	Key Generation	163
111	Expired Password Prompt	165
112	Change Profile	166
113	Set Real Time Clock	167
114	Set SMS Service Center Address	168
115	Unlock SIM Card	168
116	Unblock SIM Card	169
117	Send SMS	170
118	Backup Configuration	171
119	Restore Configuration	172
120	Update Firmware Administration Page	173
121	Process of Firmware Update	174
122	Reboot	174
123	Access to the Internet from LAN – sample topology	175
124	Access to the Internet from LAN – <i>Ethernet</i> configuration	176
125	Access to the Internet from LAN – <i>Mobile WAN</i> configuration	176
126	Backup access to the Internet – sample topology	177
127	Backup access to the Internet – Ethernet configuration	177
128	Backup access to the Internet – WiFi configuration	178
129	Backup access to the Internet – Mobile WAN configuration	179
130	Backup access to the Internet – Backup Routes configuration	180
131	Secure Networks Interconnection – Sample Topology	181
132	Secure Networks Interconnection – OpenVPN Configuration	182

List of Tables

1	Reset Storage Actions	7
2	Mobile Connection	8
3	PoE PSE Status	9
4	Peripheral Ports	10
5	System Information	11
6	Mobile Network Information for 1st/2nd Module	12
7	Value ranges of signal strength for different technologies.	13
8	Description of Periods	13
9	Mobile Network Statistics	13
10	Detailed Information about WiFi Networks	18
11	Description of Interfaces in Network Status	19
12	Description of Information in Network Status	20
13	DHCP Status Description	23
14	Configuration of the Network Interface – IPv4 and IPv6	29
15	Configuration of the Network Interface – Global Items	30
16	Configuration of the Dynamic DHCP Server	31
17	Configuration of Static DHCP Server	31
18	IPv6 Prefix Delegation Configuration	32
19	Supported Roles for IEEE 802.1X Authentication	34
20	Configuration of 802.1X Authentication	34
21	VLAN Configuration Options	42
22	VRRP Configuration Items Description	43
23	Check Connection Parameters	43
24	Mobile WAN Connection Configuration	46
25	Check Connection to Mobile Network Configuration	48
26	Data Limit Configuration	49
27	Switch between SIM cards configuration	50
28	Parameters for SIM card switching	51
29	Module Switching Configuration	56
30	PPPoE Configuration	59
31	WiFi Configuration Items Description	64
32	WLAN Configuration Items Description	69
33	Backup Routes Modes Items Description	71
34	Backup Routes Configuration Items Description	72
35	Static Routes Configuration for IPv4	82
36	Filtering of Incoming Packets	84
37	Forward Filtering	85
38	NAT Configuration Items Description	88
39	Remote Access Configuration	89
40	Incoming Packets Configuration	90
41	Related Features Configuration	90
42	OpenVPN Configuration Items Description	95
43	OpenVPN Configuration Example	97
44	IPsec Tunnel Configuration Items Description	104
45	Simple IPv4 IPsec Tunnel Configuration	105
46	WireGuard Tunnel Configuration Items Description	107
47	WireGuard IPv4 Tunnel Configuration Example	108

48	GRE Tunnel Configuration Items Description	110
49	GRE Tunnel Configuration Example	112
50	L2TP Tunnel Configuration Items Description	114
51	L2TP Tunnel Configuration Example	115
52	PPTP Tunnel Configuration Items Description	117
53	PPTP Tunnel Configuration Example	118
54	Enter Caption	120
55	Configuration of RADIUS	121
56	Configuration of TACACS+	122
57	DynDNS Configuration Items Description	123
58	FTP Configuration Items Description	124
59	HTTP Configuration Items Description	125
60	NTP Configuration Items Description	126
61	SNMP Agent Configuration	127
62	SNMPv3 Configuration	127
63	SNMP Configuration (R-SeeNet)	127
64	Object Identifiers for Binary Inputs and Outputs	128
65	SMTP Client Configuration	131
66	SMS Configuration	133
67	Control via SMS and AT-SMS over TCP	133
68	Control SMS	134
69	Sending/receiving of SMS on TCP port specified	135
70	List of AT Commands	135
71	SSH Configuration Items Description	140
72	Syslog Configuration Items Description	143
73	Telnet Configuration Items Description	144
74	USB Port Configuration 1	145
75	USB Port Configuration 2	146
76	Automatic Update Options	151
77	Router Apps Settings	156
78	Action Button Description	158
79	User Parameters	158

1. Getting Started

1.1 Document Content

This manual provides detailed setup procedures for Advantech SmartMotion family routers, offering comprehensive guidance on the following topics:

- Web configuration interface for the routers – detailed in Chapter 1.2.
- Overview of available remote management system – see Chapter 1.2.2.
- Detailed configuration instructions, item by item, following the web interface's structure:
 - Status – discussed in Chapter 2.
 - Configuration – outlined in Chapter 3.
 - Customization – covered in Chapter 4.
 - Administration – explained in Chapter 5.
- Configuration examples for typical scenarios – presented in Chapter 6.



For detailed information on topics such as ordering, hardware features, initial setup, and technical specifications, refer to the **Hardware Manual** available on the [Engineering Portal](#).

1.2 Configuration Environments

- 
- If you are unsure about the correctness of your configuration or its potential impact on the router's longevity, consult our technical support for guidance.
 - Before putting the router into operation, make sure to connect all the components required for running your applications. Refer to the [Hardware Manual](#) for details.
 - For security reasons, we recommend regularly updating the router's firmware to the latest version. Downgrading the firmware to an older version than the production version or uploading firmware intended for a different device may cause the device to malfunction.
 - It is highly recommended to have JavaScript enabled in the browser; otherwise, field validation and some functions will be disabled.
 - Three unsuccessful login attempts will block HTTP(S) access from the IP address for one minute.
 - All routers have the *WebAccess/DMP* client pre-installed by default. The activated client periodically uploads router identifiers and configuration to the *WebAccess/DMP* server. See Chapter [1.2.2 Remote Management Platform](#) for more information.

For configuring an Advantech router, one of the following environments may be used:

- Via a **graphical interface** accessible in a **web browser**. This option is primarily covered in this manual, start with Chapter [1.2.1 Web Interface Initial Setup](#).
- Via a **console interface** accessing the router by **Secure Shell** (SSH). For console configuration commands, refer to the [Command Line Interface](#) Application Note.
- Via Advantech's **remote device management** platform, *WebAccess/DMP*, which provides extensive management and monitoring capabilities to ensure devices remain secure and up-to-date. For more information, refer to Chapter [1.2.2 Remote Management Platform](#).

For more information on enhancing the router's basic functionality, refer to the [Extending Router Functionality](#) Application Note.

1.2.1 Web Interface Initial Setup

- Please note that if you are logged in to the router configuration web interface with the *User* role, you will have read-only access to the GUI, except for *Modify User*, and some menu items may be unavailable.
- Refer to Chapter [Allowed and Restricted Input Characters](#) for the rules regarding characters used in the graphical web interface.
- Configure the router's *Name* and *Location* in the SNMP settings to display them in the web interface's upper right corner. See Chapter [3.20.6 SNMP](#) for details.



Routers can be efficiently configured through a username and password-protected web interface (see Figure 1). This interface offers a comprehensive configuration GUI, detailed statistics on router activities, signal strength, system logs, and more.

To access the router's web interface on a new router with default settings, follow these steps:

- For cellular routers, it is essential to correctly configure the carrier settings and activate the account. Ensure that you insert the appropriate SIM card. For detailed guidance, refer to the [Hardware Manual](#), Chapter [SIM Card Slots](#). If a PIN is required for the SIM card, follow the instructions in Chapter [5.6 Unlock SIM Card](#).
- Before connecting the router to a power supply, attach the cellular antenna (or antennas). Ideally, attach all antennas, including the WiFi antennas for WiFi models.
- Connect the power supply to the router (refer to the [Hardware Manual](#), Chapter [Power Supply](#)).
- The router will initiate its boot process. By default, the cellular router will automatically establish a connection to the default Access Point Name (APN) associated with the inserted SIM card.
- Ensure that your PC is configured to obtain IP settings automatically (DHCP client) from the network and connect its Ethernet interface to the router's default LAN interface (ETH0 port).
- The DHCP server running by default on the router will assign an IP address to your PC. Enter the following URL in your web browser's address bar: <https://192.168.1.1>. Please note that using the HTTPS protocol for secure communication over the network is mandatory.
- The only user in the new router is user `root` having the *Admin* role.
- Check the **product label** on the router for the **default password**¹.
- Upon **first login** to the new router, the user will be prompted to **change their password**.
- **Note:** To prevent domain mismatch warnings, you will need to install a security certificate. For detailed instructions, see Chapter [Managing HTTPS Certificates](#).

¹If the router's label does not specify a unique password, use `root` as the default password.

Status	General Status refresh
<ul style="list-style-type: none"> General Mobile WAN WiFi Network DHCP IPsec WireGuard DynDNS System Log 	<div style="background-color: #e6f2ff; padding: 2px; text-align: center;">Mobile Connection of 1st Module</div> <p>SIM Card : 1st IP Address : 10.80.0.68 IPv6 Address : Unassigned Rx Data : 588 B Tx Data : 846 B Uptime : 0 days, 15 hours, 47 minutes</p> <p>» More Information «</p>
Configuration	<div style="background-color: #e6f2ff; padding: 2px; text-align: center;">Mobile Connection of 2nd Module</div> <p>SIM Card : 3rd IP Address : 10.80.0.53 IPv6 Address : Unassigned Rx Data : 588 B Tx Data : 846 B Uptime : 0 days, 15 hours, 47 minutes</p> <p>» More Information «</p>
<ul style="list-style-type: none"> Ethernet VLAN VRRP Mobile WAN PPPoE WiFi Backup Routes Static Routes Firewall NAT OpenVPN IPsec WireGuard GRE L2TP PPTP Services USB Port Scripts Automatic Update 	<div style="background-color: #e6f2ff; padding: 2px; text-align: center;">ETH0</div> <p>IP Address : 10.64.0.70 / 255.255.252.0 IPv6 Address : fd00:a40::70 / 56 MAC Address : 02:AD:FF:00:00:70 Rx Data : 52.5 KB Tx Data : 63.5 KB</p> <p>» More Information «</p>
Customization	<div style="background-color: #e6f2ff; padding: 2px; text-align: center;">ETH1</div> <p>IP Address : 10.65.0.70 / 255.255.252.0 IPv6 Address : fd00:a41::70 / 56 MAC Address : 02:AD:FF:01:00:70 Rx Data : 51.2 KB Tx Data : 24.3 KB</p> <p>» More Information «</p>
Administration	<div style="background-color: #e6f2ff; padding: 2px; text-align: center;">WiFi AP 1</div> <p>IP Address : Unassigned IPv6 Address : Unassigned MAC Address : 20:C3:8F:F1:BE:73</p> <p>» More Information «</p>
<ul style="list-style-type: none"> Router Apps Settings 	<div style="background-color: #e6f2ff; padding: 2px; text-align: center;">WiFi STA</div> <p>IP Address : Unassigned IPv6 Address : Unassigned MAC Address : 20:C3:8F:F1:BE:74</p> <p>» More Information «</p>
<ul style="list-style-type: none"> Manage Users Change Profile Set Date and Time Set SMS Service Center Unlock SIM Card Unblock SIM Card Send SMS Backup Configuration Restore Configuration Update Firmware Reboot Logout 	<div style="background-color: #e6f2ff; padding: 2px; text-align: center;">Peripheral Ports</div> <p>Binary Input 0 : On Binary Input 1 : On Binary Output : On</p>
	<div style="background-color: #e6f2ff; padding: 2px; text-align: center;">Security Information</div> <p>User : root Last login : 2024-09-22 19:28:20 from 10.64.0.1 (ssh, 04:d9:f5:15:33:58) Failed logins : 0</p>
	<div style="background-color: #e6f2ff; padding: 2px; text-align: center;">System Information</div> <p>Firmware Version : 6.5.0-alpha (2024-09-22) TEST #2766 Serial Number : ACZ1199000000702 Hardware UUID : N/A Product Revision : N/A Profile : Standard Free space : 130 MB for apps, 90 kB for data RTC Battery : Ok Supply Voltage : 24.2 V Temperature : 35 °C Time : 2024-09-23 11:15:24 Uptime : 0 days, 15 hours, 47 minutes</p> <p>» More Information «</p> <p>» Licenses «</p>

Figure 1: Web Configuration GUI

Managing HTTPS Certificates

The router includes a self-signed HTTPS certificate. Since the identity of this certificate cannot be validated, web browsers may display a warning message. To avoid this warning, you can upload your own certificate—signed by a Certification Authority—to the router. If you wish to use your own certificate (for example, in combination with a dynamic DNS service), replace the `/etc/certs/https_cert` and `/etc/certs/https_key` files on the router. This can easily be done via the GUI on the *HTTP* configuration page, as detailed in Chapter 3.20.4.

To use the router's self-signed certificate without encountering the security warning (due to a domain name mismatch) each time you log in, follow these steps:

- Add a DNS record to your DNS system. For Linux/Unix systems, edit `/etc/hosts`; for Windows, navigate to `C:\WINDOWS\system32\drivers\etc\hosts`; or configure your own DNS server. Insert a new record pairing the router's IP address with a domain name derived from its MAC address (specifically, the MAC address of the first network interface, as shown in the *Network Status* on the router's web interface), using dashes instead of colons for separation. For example, a router with the MAC address `00:11:22:33:44:55` would use the domain name `00-11-22-33-44-55`.
- Access the router via this new domain name (e.g., `https://00-11-22-33-44-55`). If a security warning appears, add an exception to prevent it from recurring (for example, in the Firefox web browser). If the option to add an exception is unavailable, export the certificate to a file and import it into your browser or operating system.

Note: Using a domain name based on the router's MAC address may not be compatible with all operating system and browser combinations.

Allowed and Restricted Input Characters

When configuring the router via the web interface, it is crucial to avoid using forbidden characters in any input field—not just in password fields. Below are the valid and forbidden characters for input. Note that, in some cases, the space character may also be disallowed.

Valid characters include: `0-9 a-z A-Z * , + - . / : = ? ! # % @ [] _ { } ~`

Forbidden characters include: `" $ & ' () ; < > \ ^ ` |`

It is important to follow these guidelines during configuration, as entering invalid characters can lead to errors or unintended behavior.

Supported Certificate Formats

All GUI forms that allow the uploading of certificate files support the following file types:

- CA, Local/Remote Certificate: `*.pem`, `*.crt`, `*.p12`
- Private Key: `*.pem`, `*.key`, `*.p12`

1.2.2 Remote Management Platform

WebAccess/DMP is an advanced, enterprise-grade platform for provisioning, monitoring, managing, and configuring Advantech's routers and IoT gateways. It offers zero-touch enablement for each remote device. For more information, refer to the application note [3] or visit the [WebAccess/DMP](#) webpage.

New routers come pre-installed with the *WebAccess/DMP* client, which by default activates the connection to the *WebAccess/DMP* server. This connection can be disabled on the *Welcome* page upon initial web interface login or under (*Customization* → *Router Apps* → *WebAccess/DMP Client*).



The activated client periodically uploads router identifiers and configurations to the *WebAccess/DMP* server.

1.3 Device

1.3.1 Persistent Storage

The device's persistent storage consists of three partitions, combined into a single directory structure:

- **System Data:** System data distributed with firmware upgrades.
- **User Data:** Separate storage for user data, accessible at `/var/data`.
- **Router Apps Installed:** Separate storage for Router Apps data, accessible at `/opt`.

1.3.2 Reset



Before performing a factory reset on the router, consider creating a backup of its configuration. See Chapter [5.9 Backup Configuration](#).

There are three different reset scenarios:

- **Reset:**
 - This reset can only be triggered by selecting the *Reboot* option in the router's web GUI.
 - The router will reboot, applying its customized configuration.
- **Configuration Reset¹:**
 - Press the *RST* button.
 - The router will reset to its default factory configuration, including RA configurations.
- **Emergency Reset¹:**
 - Use this option if the router fails to boot due to incorrect configuration or a filesystem error.
 - Power off the router by disconnecting its power supply. Then, while holding the *RST* button, **power on the router** and continue holding the *RST* button for **at least 10 seconds**.
 - The router will reset its configuration, including RA configurations, similar to the *Configuration Reset*.

The following table summarizes which storage areas are retained and which are deleted during different reset procedures.

Storage	Reset	Configuration Reset	Emergency Reset
Router & RA Configuration	Keep	Reset to default	Reset to default
System Data	Keep	Keep	Keep
User Data	Keep	Keep	Keep
Router Apps Installed	Keep	Keep	Keep

Table 1: Reset Storage Actions

¹Upon first login after a reset, the user will be prompted to change their password.

2. Status



All status pages can display live data. To enable this feature, click on the *refresh* button in the top right corner on the status page. To stop the data update and to limit the amount of data transferred, disable automatic data updates by clicking the *pause* button again.

2.1 General

You can reach a summary of basic router information and its activities by opening the *General* status page. This page is displayed when you log in to the device by default. The information displayed on this page is divided into several sections, based upon the type of the router and its hardware configuration. Typically, there are sections for the mobile connection, LAN, system information, system information, and eventually for the WiFi and peripheral ports, if the device is equipped with.



IPv6 Address item can show multiple different addresses for one network interface. This is standard behavior since an IPv6 interface uses more addresses. The second IPv6 Address showed after pressing *More Information* is automatically generated EUI-64 format link local IPv6 address derived from MAC address of the interface. It is generated and assigned the first time the interface is used (e.g. cable is connected, Mobile WAN connecting, etc.).

2.1.1 Mobile Connection

Item	Description
SIM Card	Identification of the SIM card
Interface	Defines the interface
Flags	Displays network interface flags: None - no flags Up - the interface is administratively enabled Running - the interface is in operational state (cable detected) Multicast - the interface is capable of multicast transmission
IP Address	IP address of the interface
MTU	Maximum packet size that the equipment is able to transmit
Rx Data	Total number of received bytes
Rx Packets	Received packets
Rx Errors	Erroneous received packets
Rx Dropped	Dropped received packets
Rx Overruns	Lost received packets because of overload
Tx Data	Total number of sent bytes
Tx Packets	Sent packets
Tx Errors	Erroneous sent packets
Tx Dropped	Dropped sent packets
Tx Overruns	Lost sent packets because of overload
Uptime	Indicates how long the connection to the cellular network has been established

Table 2: Mobile Connection

2.1.2 Ethernet

Every Ethernet interface has its separate section on the *General* status page. Items displayed here have the same meaning as items in *Mobile Connection* part. Moreover, the *MAC Address* item shows the MAC address of the corresponding router's interface. Visible information depends on the Ethernet configuration, see Chapter 3.1.

PoE PSE Status

If the router is equipped with the PoE PSE board, there is information about it in the appropriate Ethernet section; see the table below for a description.

Item	Description
LAN1 PoE PSE LAN2 PoE PSE LAN3 PoE PSE LAN4 PoE PSE	<ul style="list-style-type: none"> • Disabled – PoE PSE is disabled in an <i>Ethernet</i> configuration page. • Undervoltage – Undervoltage, router power supply does not meet the PoE required voltage. • Overcurrent / incompatible device – Overcurrent, a higher current than the permissible positive difference of the nominal current or a PoE incompatible device connected. • Idle – PoE PSE is enabled but currently not used (any device powered). • Class 0 – Power level (classification unimplemented) • Class 1 – Power level (very low power) • Class 2 – Power level (low power) • Class 3 – Power level (mid power) • Class 4¹ – Power level (high power)
PoE PSE Power ²	Power of PoE PSE [W]
PoE PSE Voltage ²	Voltage of PoE PSE [V]
PoE PSE Current ²	Current of PoE PSE [mA]

Table 3: PoE PSE Status

2.1.3 WiFi

Items displayed in this part have the same meaning as items in the *Mobile Connection* part. *WiFi AP* part displays information for the WiFi interface working in access point mode, for the configuration see Chapter 3.8. *WiFi STA* part displays information for the WiFi interface working in station mode, for the configuration description see Chapter 3.9.

¹Valid for *IEEE 802.3at/PoE+ Type 2* devices, not allowed for *IEEE 802.3at/PoE Type 1* devices.

²Visible only when the PoE is enabled, and an external device is powered.

2.1.4 Peripheral Ports

Information about installed peripheral ports is displayed in the *Peripheral Ports* section.

Item	Description
Expansion Port 1	Expansion port fitted to the position 1 (<i>None</i> indicates that this position is equipped with no port).
Expansion Port 2	Expansion port fitted to the position 2 (<i>None</i> indicates that this position is equipped with no port).
Binary Input 0	State of the first binary input.
Binary Input 1	State of the second binary input.
Binary Output	State of binary output.

Table 4: Peripheral Ports

2.1.5 Security Information

This section provides information about the logged-in user, their last login time, IP address, and the number of failed login attempts.

2.1.6 System Information

System information about the device is displayed in the *System Information* section.

Item	Description
Product Name	Name of the product (may not match with the P/N or order code).
Product Type	Type of the product (may be N/A or the same as the Product Name).
Firmware Version	Information about the firmware version.
Serial Number	Serial number of the router (in case of N/A is not available).
Hardware UUID ¹	Unique HW identifier for the device.
Product Revision ¹	Manufactured product revision number.
Profile	Current profile – standard or alternative profiles (profiles are used for example to switch between different modes of operation).
Free space	Free space available for Router Apps and user data.
CPU Usage	CPU usage value (turn on the refresh in the top right corner).
Memory Usage	Memory usage value (turn on the refresh in the top right corner).
Power Board ²	Detected type of the PoE extension board.
RTC Battery	RTC battery state.
Supply Voltage	Supply voltage of the router.
Temperature	Temperature in the router.
Time	Current date and time.
Uptime	Indicates how long the router is used.
Licenses	Link to the list of open source software components of the firmware together with their license type. Click on the license type to see the license text.

Table 5: System Information

¹It may not be available for some models.

²Only for models with PoE. The router's power supply voltage must meet the required voltage.

2.2 Mobile WAN

The *Mobile WAN* menu item contains current information about connections to the mobile network. On the upper part of the page there are *Mobile Network Information for 1st Module* and *Mobile Network Information for 2nd Module* displayed (information about mobile networks the router operates in). There are also information about the modules mounted in the router.

Item	Description
Registration	State of the network registration
Operator	Specifies the operator's network the router operates in.
Technology	Transmission technology
PLMN	Code of operator
Cell	Cell the router is connected to (in hexadecimal format).
LAC/TAC	Unique number (in hexadecimal format) assigned to each location area. LAC (Location Area Code) for 2G/3G networks and TAC (Tracking Area Code) for 4G networks.
Channel	Channel the router communicates on <ul style="list-style-type: none"> • ARFCN in case of GPRS/EDGE technology, • UARFCN in case of UMTS/HSPA technology, • EARFCN in case of LTE technology.
Band	Cellular band abbreviation.
Signal Strength	Signal strength (in dBm) of the selected cell, for details see Table 7.
Signal Quality	Signal quality of the selected cell: <ul style="list-style-type: none"> • EC/IO for UMTS (it's the ratio of the signal received from the pilot channel – EC – to the overall level of the spectral density, ie the sum of the signals of other cells – IO). • RSRQ for LTE technology (defined as the ratio $\frac{N \times RSRP}{RSSI}$). • The value is not available for the EDGE technology.
RSSI, RSRP, RSRQ, SINR, RSCP or Ec/Io	Other parameters reporting signal strength or quality. Please note, that some of them may not be available, depending on the cellular module or cellular technology.
CSQ	Cell signal strength with following value ranges: <ul style="list-style-type: none"> • 2–9 = Marginal, • 10–14 = OK, • 15–19 = Good, • 20–30 = Excelent.
Neighbours	Signal strength of neighboring hearing cells (GPRS only) ¹ .
Manufacturer	Module manufacturer
Model	Type of module
Revision	Revision of module
IMEI	IMEI (International Mobile Equipment Identity) number of module
MEID	MEID number of module
ICCID	Integrated Circuit Card Identifier is international and unique serial number of the SIM card.

Table 6: Mobile Network Information for 1st/2nd Module

The value of signal strength is displayed in different color: in black for good, in orange for fair and in red for poor signal strength.

The middle part of this page, called *Statistics*, displays information about mobile signal quality, transferred data and number of connections for all the SIM cards (for each period). The router has standard intervals, such as the previous 24 hours and last week, and also period starting with *Accounting Start* defined for the MWAN module.

¹If a neighboring cell for GPRS is highlighted in red, router may repeatedly switch between the neighboring and the primary cell affecting the router's performance. To prevent this, re-orient the antenna or use a directional antenna.

Signal strength	GPRS/EDGE/CDMA (RSSI)	UMTS/HSPA (RSCP)	LTE (RSRP)
good	> -70 dBm	> -75 dBm	> -90 dBm
fair	-70 dBm to -89 dBm	-75 dBm to -94 dBm	-90 dBm to -109 dBm
poor	< -89 dBm	< -94 dBm	< -109 dBm

Table 7: Value ranges of signal strength for different technologies.

Period	Description
Today	Today from 0:00 to 23:59
Yesterday	Yesterday from 0:00 to 23:59
This week	This week from Monday 0:00 to Sunday 23:59
Last week	Last week from Monday 0:00 to Sunday 23:59
This period	This accounting period
Last period	Last accounting period

Table 8: Description of Periods

Item	Description
RX data	Total volume of received data
TX data	Total volume of sent data
Connections	Number of connection to mobile network establishment
Signal Min	Minimal signal strength
Signal Avg	Average signal strength
Signal Max	Maximal signal strength
Cells	Number of switch between cells
Availability	Availability of the router via the mobile network (expressed as a percentage)

Table 9: Mobile Network Statistics



Tips for *Mobile Network Statistics* table:

- *Availability* is expressed as a percentage. It is the ratio of time connection to the mobile network has been established to the time that router has been is turned on.
- Placing your cursor over the maximum or minimum signal strength will display the last time the router reached that signal strength.

The last part (*Connection Log*) displays information about the mobile network connections and any problems that occurred while establishing them.

refresh

Mobile WAN Status

Mobile Network Information for 1st Module

Registration : Home Network
 Operator : Vodafone CZ
 Technology : LTE
 PLMN : 23003
 Cell : 10A802
 LAC : 947C
 Channel : 275
 Signal Strength : -90 dBm
 Signal Quality : -12 dB

» More Information «

Mobile Network Information for 2nd Module

Registration : Home Network
 Operator : Vodafone CZ
 Technology : LTE
 PLMN : 23003
 Cell : 10A80C
 LAC : 947C
 Channel : 6400
 Signal Strength : -76 dBm
 Signal Quality : -7 dB

» More Information «

Statistics for 1st SIM card						
	Today	Yesterday	This Week	Last Week	This Period	Last Period
Rx Data	: 0 KB	9 KB	9 KB	0 KB	9 KB	0 KB
Tx Data	: 0 KB	450 KB	450 KB	0 KB	450 KB	0 KB
Connections	: 1	4	5	0	5	0
Signal Min	: -94 dBm	-93 dBm	-94 dBm	?	-94 dBm	?
Signal Avg	: -82 dBm	-81 dBm	-82 dBm	?	-82 dBm	?
Signal Max	: -75 dBm	-77 dBm	-75 dBm	?	-75 dBm	?
Cells	: 6	6	11	0	11	0
Availability	: 99.9%	99.4%	99.8%	0.0%	99.8%	0.0%

Statistics for 2nd SIM card						
	Today	Yesterday	This Week	Last Week	This Period	Last Period
Rx Data	: 0 KB	0 KB	0 KB	0 KB	0 KB	0 KB
Tx Data	: 0 KB	0 KB	0 KB	0 KB	0 KB	0 KB
Connections	: 0	0	0	0	0	0
Signal Min	: ?	?	?	?	?	?
Signal Avg	: ?	?	?	?	?	?
Signal Max	: ?	?	?	?	?	?
Cells	: 0	0	0	0	0	0
Availability	: 0.0%	0.0%	0.0%	0.0%	0.0%	0.0%

Statistics for 3rd SIM card						
	Today	Yesterday	This Week	Last Week	This Period	Last Period
Rx Data	: 0 KB	0 KB	0 KB	0 KB	0 KB	0 KB
Tx Data	: 0 KB	484 KB	484 KB	0 KB	484 KB	0 KB
Connections	: 1	4	5	0	5	0
Signal Min	: -77 dBm	-77 dBm	-77 dBm	?	-77 dBm	?
Signal Avg	: -75 dBm	-76 dBm	-75 dBm	?	-75 dBm	?
Signal Max	: -72 dBm	-74 dBm	-72 dBm	?	-72 dBm	?
Cells	: 1	1	1	0	1	0
Availability	: 99.9%	99.3%	99.8%	0.0%	99.8%	0.0%

Statistics for 4th SIM card						
	Today	Yesterday	This Week	Last Week	This Period	Last Period
Rx Data	: 0 KB	0 KB	0 KB	0 KB	0 KB	0 KB
Tx Data	: 0 KB	0 KB	0 KB	0 KB	0 KB	0 KB
Connections	: 0	0	0	0	0	0
Signal Min	: ?	?	?	?	?	?
Signal Avg	: ?	?	?	?	?	?
Signal Max	: ?	?	?	?	?	?
Cells	: 0	0	0	0	0	0
Availability	: 0.0%	0.0%	0.0%	0.0%	0.0%	0.0%

Connection Log for 1st Module

2019-08-22 00:11:44 (1st SIM card) Connection successfully established.

Connection Log for 2nd Module

2019-08-22 00:11:42 (3rd SIM card) Connection successfully established.

Figure 2: Mobile WAN status

2.3 WiFi



This feature is accessible only on routers equipped with a WiFi module.

Selecting the *Status* → *WiFi* → *Status* option in the web interface's main menu displays details about the WiFi access point (AP) and the WiFi station (STA), including a list of all stations connected to the AP.

An example output for WiFi status is illustrated in the figure below. It includes information on the WiFi chip, its firmware version, and the supported modes for the module. For instance, the notation "Supports 1 station and 2 access points" indicates that it is possible to use one station configuration alongside two distinct Access Point configurations simultaneously.

```
WiFi Status refresh  
  
WiFi Module Information  
Chip           : Qualcomm Atheros QCA6174A-5  
Firmware       : WLAN.RM.4.4.1.c3-00059  
Supports       : 1 station and 2 access points  
  
WiFi AP 1 Status  
  
AP status is not available.  
  
WiFi AP 2 Status  
  
AP status is not available.  
  
WiFi STA Status  
  
STA status is not available.
```

Figure 3: WiFi Status

2.4 WiFi Scan



This feature is accessible only on routers equipped with a WiFi module.

Selecting *Status* → *WiFi* → *Scan* initiates a scan for nearby WiFi networks, with the results displayed as shown in Figure 4.

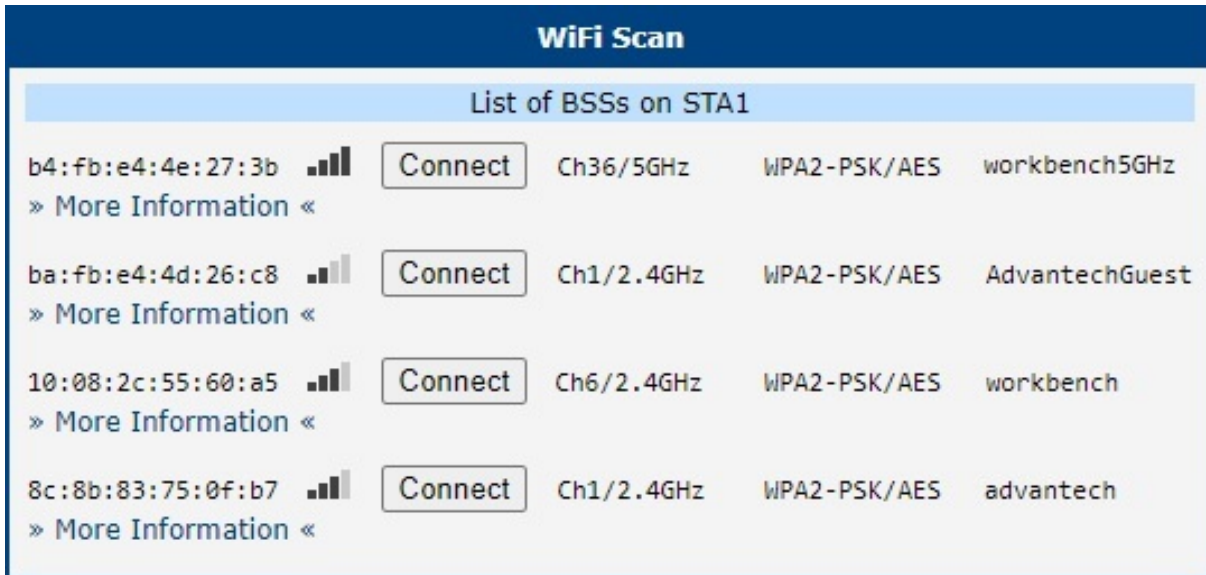

Figure 4: WiFi Scan Output Example

If you click on the *Connect* button next to the respective WiFi network, you will be redirected to the *Configuration* → *WiFi* → *Station* page, where the available fields will be pre-filled and you will be able to connect to the network by entering authentication details.

For each network, you can view details by clicking on the *More Information* button. Below is the description of some items from the WiFi scanning output.

Item	Description
BSS	MAC address of the access point (AP).
TSF	Synchronizes timers across all stations in a Basic Service Set (BSS).
freq	Frequency band of the WiFi network in MHz.
beacon interval	Time between synchronization beacons.
capability	Properties list of the access point (AP).
signal	Signal strength of the access point (AP).
last seen [boottime]	Timestamp of the last time the access point (AP) was detected, relative to the scanning device's boot time.
last seen [ms ago]	Timestamp of the last response from the access point (AP).
SSID	Name identifier of the access point (AP).
Supported rates	Data rates supported by the access point (AP).
DS Parameter set	Broadcasting channel of the access point (AP).
ERP	Provides backward compatibility for PHY rates.

Continued on next page

Continued from previous page

Item	Description
RSN	Protocol ensuring secure wireless communication.
Extended supported rates	Additional supported rates beyond the basic eight.
Country	Regulatory domain for the AP, dictating operational parameters.
BSS Load	Current load information on the Basic Service Set (BSS).
RM enabled capabilities	AP's ability to report radio spectrum measurements.
(V)HT capabilities	Features enhancing data rates for 802.11ac/n networks.
(V)HT operation	Utilization of (V)HT capabilities in the current setup.
Overlapping BSS scan params	Guides scanning for overlapping BSS to minimize interference.
Extended capabilities	Additional AP features improving network functions.
WMM	Prioritizes network traffic to ensure quality for voice and video.

Table 10: Detailed Information about WiFi Networks

2.5 Network

To view information about the interfaces and the routing table, open the *Network* item in the *Status* menu. The upper part of the window displays detailed information about the active interfaces only:

Note: Some interfaces may not be available on your router, depending on the router hardware.

Interface	Description
ethx	Ethernet interfaces
lanx	LAN interfaces
lo	Local loopback interface
null0	Loopback interface used by the translator gateway between IPv6 and IPv4 addresses.
switch0	SWITCH interface
usbx	Active connection to the mobile network – wireless module is connected via USB interface.
wlanx	WiFi interfaces – if configured
pppx	PPP interfaces (e.g., PPPoE tunnel – if configured)
tunx	OpenVPN tunnel interfaces – if configured
ipsecx	IPSec tunnel interfaces – if configured
grex	GRE tunnel interfaces – if configured
wgx	WireGuard tunnel interfaces – if configured

Table 11: Description of Interfaces in Network Status

The following information can be displayed for network interfaces:

Item	Description
HWaddr	Hardware (unique, MAC) address of a network interface.
inet addr	IPv4 address of interface
inet6 addr	IPv6 address of interface. There can be more of them for single network interface.
P-t-P	IP address of the opposite end (in case of point-to-point connection).
Bcast	Broadcast address
Mask	Mask of network
MTU	Maximum packet size that the equipment is able to transmit.
Metric	Number of routers the packet must go through.
RX	<ul style="list-style-type: none"> • packets – received packets • errors – number of errors • dropped – dropped packets • overruns – incoming packets lost because of overload. • frame – wrong incoming packets because of incorrect packet size.

Continued on next page

Continued from previous page

Item	Description
TX	<ul style="list-style-type: none"> • packets – transmit packets • errors – number of errors • dropped – dropped packets • overruns – outgoing packets lost because of overload. • carrier – wrong outgoing packets with errors resulting from the physical layer.
collisions	Number of collisions on physical layer.
txqueuelen	Length of buffer (queue) of the network interface.
RX bytes	Total number of received bytes.
TX bytes	Total number of transmitted bytes.

Table 12: Description of Information in Network Status

You may view the status of the mobile network connection on the network status screen. If the connection to the mobile network is active, it will appear in the system information as a usb0 interface.

The *Route Table* is displayed on the *Network Status* page. Both the *IPv4 Route Table* and the *IPv6 Route Table* are shown below.

At the bottom of the page, there is a *Backup Routes* section, which reports the currently selected Backup Routes.

If NAT64 is enabled (*Configuration* → *NAT* → *IPv6* → *Enable NAT64*), it is automatically used when connected via IPv6 and communicating with an IPv4 device or network. This works in conjunction with DNS64 running on the router, which translates domain names to IP addresses. The default NAT64 prefix, 64:ff9b::/96, is used, as seen in Figure 5 below in the *IPv6 Route Table* section.

refresh

Network Status

Interfaces

```

eth0   Link encap:Ethernet HWaddr 02:AD:FF:00:00:91
       inet addr:10.64.0.91 Bcast:10.64.3.255 Mask:255.255.252.0
       inet6 addr: fe80::ad:ffff:fe00:91/64 Scope:Link
       inet6 addr: fd00:a40:91/56 Scope:Global
       UP BROADCAST RUNNING MULTICAST MTU:1500 Metric:1
       RX packets:954 errors:0 dropped:0 overruns:0 frame:0
       TX packets:749 errors:0 dropped:0 overruns:0 carrier:0
       collisions:0 txqueuelen:1000
       RX bytes:82340 (80.4 KB) TX bytes:969616 (946.8 KB)

eth1   Link encap:Ethernet HWaddr 02:AD:FF:01:00:91
       inet addr:10.65.0.91 Bcast:10.65.3.255 Mask:255.255.252.0
       inet6 addr: fd00:a41:91/56 Scope:Global
       inet6 addr: fe80::ad:ffff:fe01:91/64 Scope:Link
       UP BROADCAST RUNNING MULTICAST MTU:1500 Metric:1
       RX packets:263 errors:0 dropped:9 overruns:0 frame:0
       TX packets:4 errors:0 dropped:0 overruns:0 carrier:0
       collisions:0 txqueuelen:1000
       RX bytes:14419 (14.0 KB) TX bytes:680 (680.0 B)

eth2   Link encap:Ethernet HWaddr 02:AD:FF:02:00:91
       inet addr:10.66.0.91 Bcast:10.66.3.255 Mask:255.255.252.0
       inet6 addr: fe80::ad:ffff:fe02:91/64 Scope:Link
       inet6 addr: fd00:a42:91/56 Scope:Global
       UP BROADCAST RUNNING MULTICAST MTU:1500 Metric:1
       RX packets:15 errors:0 dropped:0 overruns:0 frame:0
       TX packets:8 errors:0 dropped:0 overruns:0 carrier:0
       collisions:0 txqueuelen:1024
       RX bytes:2234 (2.1 KB) TX bytes:1008 (1008.0 B)

lan1   Link encap:Ethernet HWaddr 02:AD:FF:00:00:91
       inet6 addr: fe80::ad:ffff:fe00:91/64 Scope:Link
       UP BROADCAST RUNNING MULTICAST MTU:1500 Metric:1
       RX packets:967 errors:0 dropped:9 overruns:0 frame:0
       TX packets:753 errors:0 dropped:0 overruns:0 carrier:0
       collisions:0 txqueuelen:1000
       RX bytes:84227 (82.2 KB) TX bytes:970216 (947.4 KB)

switch0 Link encap:Ethernet HWaddr 02:AD:FF:00:00:91
        inet6 addr: fe80::ad:ffff:fe00:91/64 Scope:Link
        UP BROADCAST RUNNING MULTICAST MTU:1500 Metric:1
        RX packets:1230 errors:0 dropped:0 overruns:0 frame:0
        TX packets:764 errors:0 dropped:0 overruns:0 carrier:0
        collisions:0 txqueuelen:1024
        RX bytes:125706 (122.7 KB) TX bytes:977642 (954.7 KB)
    
```

Route Table

Destination	Gateway	Genmask	Flags	Metric	Ref	Use	Iface
0.0.0.0	192.168.253.254	0.0.0.0	UG	0	0	0	usb0
10.64.0.0	0.0.0.0	255.255.252.0	U	0	0	0	eth0
10.65.0.0	0.0.0.0	255.255.252.0	U	0	0	0	eth1
10.66.0.0	0.0.0.0	255.255.252.0	U	0	0	0	eth2
10.70.0.0	0.0.0.0	255.255.252.0	U	0	0	0	wlan0
10.72.0.0	0.0.0.0	255.255.252.0	U	0	0	0	wlan02
192.168.253.254	0.0.0.0	255.255.255.255	UH	0	0	0	usb0

IPv6 Route Table

Destination	Next Hop	Flags	Metric	Ref	Use	Iface
64:ff9b::/96	::	U	256	1	0	nat64
ff00::/8	::	U	256	1	0	nat64
::/0	::	!n	-1	1	1	lo

Backup Routes

```

IP      : usb0
IPv6    : N/A
    
```

» Connections «

Figure 5: Network Status

2.5.1 Connections

On the *Network Status* page, scroll down and click the »Connections« link. A new window listing all active router connections will display, see Figure 6.

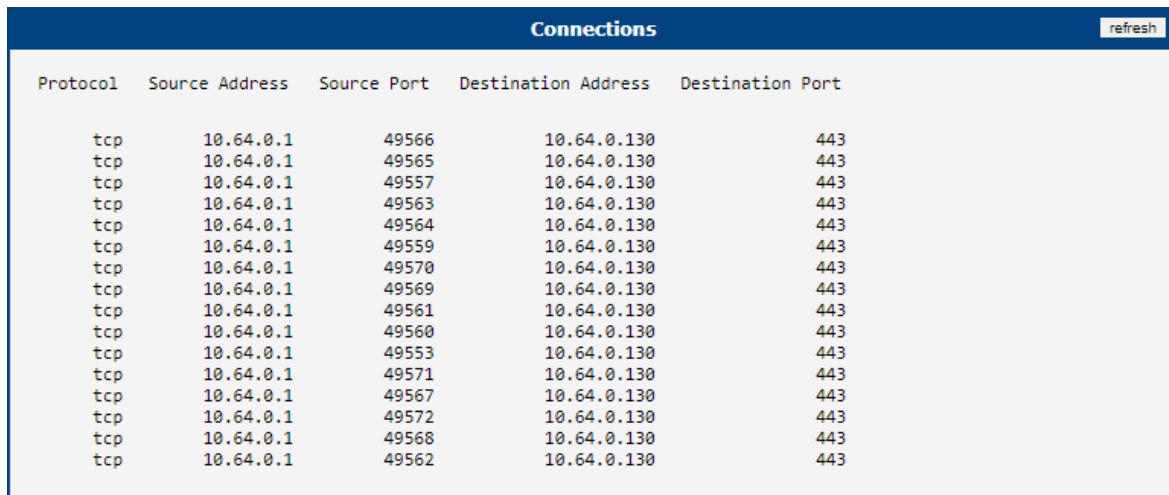

Protocol	Source Address	Source Port	Destination Address	Destination Port
tcp	10.64.0.1	49566	10.64.0.130	443
tcp	10.64.0.1	49565	10.64.0.130	443
tcp	10.64.0.1	49557	10.64.0.130	443
tcp	10.64.0.1	49563	10.64.0.130	443
tcp	10.64.0.1	49564	10.64.0.130	443
tcp	10.64.0.1	49559	10.64.0.130	443
tcp	10.64.0.1	49570	10.64.0.130	443
tcp	10.64.0.1	49569	10.64.0.130	443
tcp	10.64.0.1	49561	10.64.0.130	443
tcp	10.64.0.1	49560	10.64.0.130	443
tcp	10.64.0.1	49553	10.64.0.130	443
tcp	10.64.0.1	49571	10.64.0.130	443
tcp	10.64.0.1	49567	10.64.0.130	443
tcp	10.64.0.1	49572	10.64.0.130	443
tcp	10.64.0.1	49568	10.64.0.130	443
tcp	10.64.0.1	49562	10.64.0.130	443

Figure 6: Connection List

2.6 DHCP

Information about the DHCP server activity is accessible via the *DHCP* item. The DHCP server automatically configures the client devices connected to the router. The DHCP server assigns each device an IP address, subnet mask, and default gateway (IP address of the router) and DNS server (IP address of the router). DHCPv6 server is supported.

See Figure 7 for the DHCP Status example. Records in the *DHCP Status* window are divided into two parts based on the interface.

DHCP Status refresh				
Active DHCP Leases (LAN)				
IPv4 Address	Lease Starts	Lease Ends	MAC	Hostname
192.168.2.2	2022-06-14 11:16:30	2022-06-14 11:26:30	aa:bb:cc:dd:ee:ff	"PETA-NB"
IPv6 Address	Lease Starts	Lease Ends	IA-NA	
2001:db8::10	2022-06-14 11:20:27	2022-06-14 11:30:27	\235{P\006\000\001\000\001%y\030DP{\235\246SK	
Active DHCP Leases (WiFi AP 1)				
IPv4 Address	Lease Starts	Lease Ends	MAC	Hostname
192.168.2.2	2022-06-14 11:30:55	2022-06-14 11:40:55	aa:bb:cc:dd:ee:ff	"Galaxy-S10"
No active dynamic DHCPv6 Leases.				
Active DHCP Leases (WiFi AP 2)				
DHCP server is disabled.				

Figure 7: DHCP Status

The DHCP status window displays the following information on a row for each client in the list. All items are described in Table 13.

Item	Description
IPv4 Address	IPv4 address assigned to a client.
IPv6 Address	IPv6 address assigned to a client.
Lease Starts	The time the IP address lease started.
Lease Ends	The time the IP address lease expires.
MAC	MAC address of the client.
Hostname	Client hostname.
IA-NA	IPv6 unique identifier.

Table 13: DHCP Status Description



The DHCP status may occasionally display two records for one IP address. It may be caused by resetting the client network interface.

2.7 IPsec

Selecting the *IPsec* option in the *Status* menu of the web page will bring up the information for any IPsec Tunnels that have been established. If the tunnel has been built correctly, the screen will display **ESTABLISHED** and the number of running IPsec connections **1 up** (orange highlighted in the figure below.) If there is no such text in log (e.g. "0 up"), the tunnel was not created!

The screenshot shows the 'IPsec Status' page with a 'refresh' button. The main content is titled 'IPsec Tunnels Information' and displays the following text:

```
Status of IKE charon daemon (weakSwan 5.5.3, Linux 3.12.10+, armv71):
uptime: 26 minutes, since Nov 09 10:26:10 2017
malloc: sbrk 528384, mmap 0, used 123104, free 405280
worker threads: 11 of 16 idle, 5/0/0/0 working, job queue: 0/0/0/0, scheduled: 5
loaded plugins: charon nonce pem openssl kernel-netlink socket-default stroke updown
Listening IP addresses:
192.168.1.1
2001:10:7:6::1
10.0.0.228
Connections:
ipsecl: 10.0.0.228...%any IKEv2, dpddelay=20s
ipsecl: local: [10.0.0.228] uses pre-shared key authentication
ipsecl: remote: uses pre-shared key authentication
ipsecl: child: 2001:10:7:6::/64 === 1999:10:7:5::/64 TUNNEL, dpdaction=clear
Security Associations (1 up, 0 connecting):
ipsecl{2}: ESTABLISHED 17 minutes ago, 10.0.0.228[10.0.0.228]...10.0.2.250[10.0.2.250]
ipsecl{2}: IKEv2 SPIs: 7e675f07f05d7434_i 8625de2fc6f84049_r*, pre-shared key reauthentication in 28 minutes
ipsecl{2}: IKE proposal: AES_CBC_128/HMAC_SHA2_256_128/PRF_HMAC_SHA2_256/MODP_3072
ipsecl{2}: INSTALLED, TUNNEL, reqid 2, ESP SPIs: c7247a03_i c29f5287_o
ipsecl{2}: AES_CBC_128/HMAC_SHA1_96, 0 bytes_i, 0 bytes_o, rekeying in 30 minutes
ipsecl{2}: 2001:10:7:6::/64 === 1999:10:7:5::/64
```

The line 'ipsecl{2}: ESTABLISHED 17 minutes ago, 10.0.0.228[10.0.0.228]...10.0.2.250[10.0.2.250]' is highlighted with an orange box, indicating a successful tunnel establishment.

Figure 8: IPsec Status

2.8 WireGuard

Selecting the *WireGuard* option in the *Status* menu of the web page will bring up the information for any WireGuard Tunnels established. In the figure below is an example of the first WireGuard tunnel running.

WireGuard Tunnel Status
refresh

1st WireGuard Tunnel Information

```

interface: wg1
  public key: Zu5pZz4h05xUDGvcFN9ULr2W0oxzcL6V4Hi+WkyE63E=
  private key: (hidden)
  listening port: 51820

peer: sHvm8R8HLQM7hRtmD+/VA8c5aIuDpGfnwq371+0gMVM=
  endpoint: 192.168.7.231:51820
  allowed ips: 10.0.0.0/30, 192.168.133.0/24
  latest handshake: 1 minute, 55 seconds ago
  transfer: 1.44 KiB received, 5.28 KiB sent
  persistent keepalive: every 25 seconds
          
```

2nd WireGuard Tunnel Information

WireGuard is disabled.

3rd WireGuard Tunnel Information

WireGuard is disabled.

4th WireGuard Tunnel Information

WireGuard is disabled.

Figure 9: WireGuard Status Page



The *Latest handshake* time is the time left from the latest successful communication with the opposite tunnel side. This item will not be shown here until there is a tunnel communication (data sent by the client-side or the keepalive data sent when *NAT/Firewall Traversal* is set to *yes*).

2.9 DynDNS

The router supports Dynamic DNS using a DNS server. If Dynamic DNS is configured, its status can be viewed by selecting the *DynDNS* menu option.



You can use the servers listed below for the Dynamic DNS service. DynDNSv6 can be used when *IP Mode* is set to *IPv6* on the *Services* → *DynDNS* configuration page.

- www.freedns.afraid.org
- www.duckdns.org
- www.noip.com

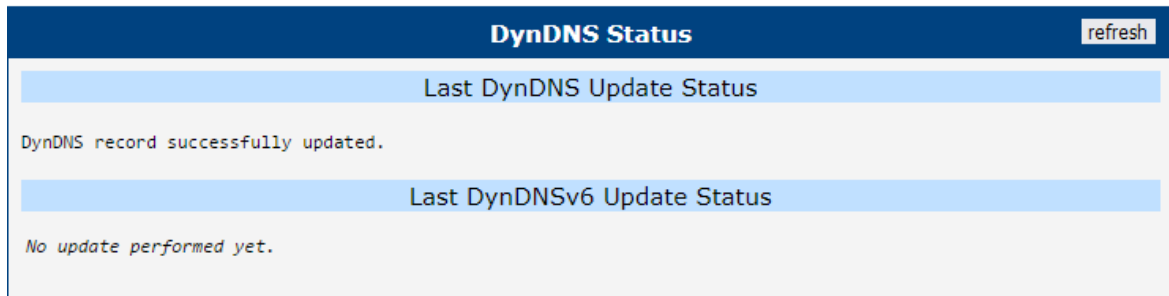

Figure 10: DynDNS Status

When the router detects a DynDNS record update, the dialog displays one or more of the following messages:

- DynDNS client is disabled.
- Invalid username or password.
- Specified hostname doesn't exist.
- Invalid hostname format.
- Hostname exists, but not under specified username.
- No update performed yet.
- DynDNS record is already up to date.
- DynDNS record successfully update.
- DNS error encountered.
- DynDNS server failure.



The router's SIM card must have public IP address assigned or DynDNS will not function correctly.

2.10 System Log

 Sensitive data in the report is filtered out for security reasons.

You can view the system log by selecting the *Status* → *System Log* menu item. This displays detailed reports from individual applications running on the router.

The default size of the system log is 1000 KiB. Once this limit is reached, a new file is created to store subsequent log entries. When the second file becomes full, the first file is overwritten. You can configure the *Log Size Limit* and other related settings in the Syslog configuration, accessible via *Configuration* → *Services* → *Syslog*.

Use the *Save Log* button to save the system log to a connected computer. The log will be saved as a text file with the `.log` extension.

The *Save Report* button generates a detailed report, saved as a text file with the `.txt` extension. This report includes system information, statistical data, routing and process tables, details of running processes, filesystem information, the system log, and configuration details.

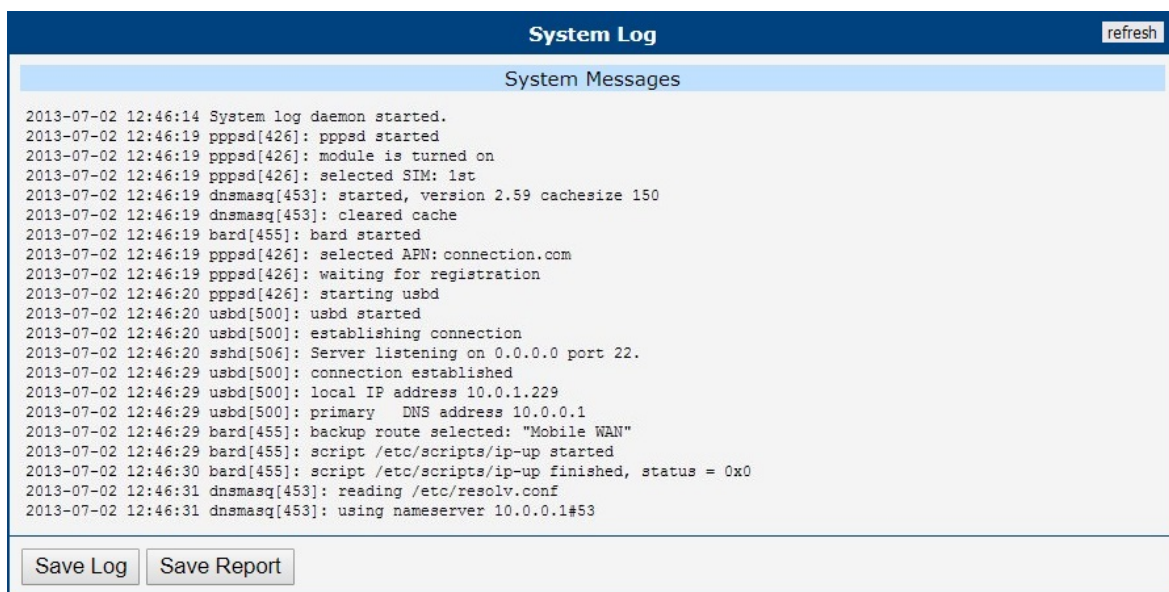

The screenshot shows a web interface titled "System Log" with a "refresh" button in the top right corner. Below the title is a header "System Messages" in a light blue bar. The main area contains a list of log entries with timestamps and messages from various system daemons. At the bottom of the interface are two buttons: "Save Log" and "Save Report".

```

2013-07-02 12:46:14 System log daemon started.
2013-07-02 12:46:19 pppsd[426]: pppsd started
2013-07-02 12:46:19 pppsd[426]: module is turned on
2013-07-02 12:46:19 pppsd[426]: selected SIM: 1st
2013-07-02 12:46:19 dnsmasq[453]: started, version 2.59 cachesize 150
2013-07-02 12:46:19 dnsmasq[453]: cleared cache
2013-07-02 12:46:19 bard[455]: bard started
2013-07-02 12:46:19 pppsd[426]: selected APN: connection.com
2013-07-02 12:46:19 pppsd[426]: waiting for registration
2013-07-02 12:46:20 pppsd[426]: starting usbd
2013-07-02 12:46:20 usbd[500]: usbd started
2013-07-02 12:46:20 usbd[500]: establishing connection
2013-07-02 12:46:20 sshd[506]: Server listening on 0.0.0.0 port 22.
2013-07-02 12:46:29 usbd[500]: connection established
2013-07-02 12:46:29 usbd[500]: local IP address 10.0.1.229
2013-07-02 12:46:29 usbd[500]: primary DNS address 10.0.0.1
2013-07-02 12:46:29 bard[455]: backup route selected: "Mobile WAN"
2013-07-02 12:46:29 bard[455]: script /etc/scripts/ip-up started
2013-07-02 12:46:30 bard[455]: script /etc/scripts/ip-up finished, status = 0x0
2013-07-02 12:46:31 dnsmasq[453]: reading /etc/resolv.conf
2013-07-02 12:46:31 dnsmasq[453]: using nameserver 10.0.0.1#53
  
```

Figure 11: System Log

3. Configuration

3.1 Ethernet

To configure the Local Area Network (LAN), navigate to the *Ethernet* menu item under the *Configuration* section. Expanding the *Ethernet* menu on the left allows you to select the appropriate Ethernet interface for configuration: *ETH0* for the first Ethernet interface and *ETH1* for the second Ethernet interface.

The LAN configuration page is divided into IPv4 and IPv6 sections, as shown in Figure 12. The router supports dual-stack operation, meaning IPv4 and IPv6 can run concurrently. You can configure either one or both. When both IPv4 and IPv6 are enabled, network devices will automatically select the appropriate protocol. The configuration options and key differences between IPv4 and IPv6 are described in the following tables.

ETH0 Configuration		
	IPv4	IPv6
DHCP Client	<input type="text" value="disabled"/>	<input type="text" value="disabled"/>
IP Address	<input type="text" value="10.64.0.37"/>	<input type="text" value="fd00:a40::99"/>
Subnet Mask / Prefix	<input type="text" value="255.255.252.0"/>	<input type="text" value="56"/>
Default Gateway	<input type="text" value="10.64.0.1"/>	<input type="text" value="fd00:a40::1"/>
Primary DNS Server	<input type="text"/>	<input type="text"/>
Secondary DNS Server	<input type="text"/>	<input type="text"/>
Bridged	<input type="text" value="no"/>	
Media Type	<input type="text" value="auto-negotiation"/>	
MTU	<input type="text" value="1500"/>	bytes
<input type="checkbox"/> Enable dynamic DHCP leases		
IP Pool Start	<input type="text" value="192.168.1.2"/>	<input type="text"/>
IP Pool End	<input type="text" value="192.168.1.254"/>	<input type="text"/>
Lease Time	<input type="text" value="600"/>	<input type="text" value="600"/> sec
<input type="checkbox"/> Enable static DHCP leases		
MAC Address	IP Address	IPv6 Address
1	<input type="text"/>	<input type="text"/>
2	<input type="text"/>	<input type="text"/>
Maximum 32 items		
<input type="checkbox"/> Enable IPv6 prefix delegation		
Subnet ID *	<input type="text"/>	
Subnet ID Width *	<input type="text"/> bits	
<input type="checkbox"/> Enable IEEE 802.1X Authentication		
Authentication Method	<input type="text" value="EAP-PEAP/MSCHAPv2"/>	
CA Certificate	<input type="text"/>	
	<input type="button" value="Choose File"/> No file chosen	
Local Certificate	<input type="text"/>	
	<input type="button" value="Choose File"/> No file chosen	
Local Private Key	<input type="text"/>	
	<input type="button" value="Choose File"/> No file chosen	
Identity	<input type="text"/>	
Password	<input type="text"/>	
* can be blank		
<input type="button" value="Apply"/>		

Figure 12: LAN Configuration Page

Item	Description
DHCP Client	<p>Enables or disables the DHCP client function. If in the IPv6 column, the DHCPv6 client is enabled. The DHCPv6 client supports all three methods of obtaining an IPv6 address – SLAAC, stateless DHCPv6, and stateful DHCPv6.</p> <ul style="list-style-type: none"> • disabled – The router does not allow automatic allocation of an IP address from a DHCP server in the LAN network. • enabled – The router allows automatic allocation of an IP address from a DHCP server in the LAN network.
IP Address	A fixed IP address for the Ethernet interface. Use IPv4 notation in the IPv4 column and IPv6 notation in the IPv6 column. Shortened IPv6 notation is supported.
Subnet Mask / Prefix	Specifies the subnet mask for the IPv4 address. In the IPv6 column, fill in the prefix for the IPv6 address – a number in the range of 0 to 128.
Default Gateway	Specifies the IP address of the default gateway. If provided, every packet with a destination not found in the routing table is sent to this IP address. Use the correct IP address notation in both the IPv4 and IPv6 columns.
Primary DNS Server	Specifies the primary IP address of the DNS server. When the IP address is not found in the routing table, the router forwards the request to the DNS server specified here. Use the correct IP address notation in both the IPv4 and IPv6 columns.
Secondary DNS Server	Specifies the secondary IP address of the DNS server.

Table 14: Configuration of the Network Interface – IPv4 and IPv6

The *Default Gateway* and *DNS Server* items are only used if the *DHCP Client* is set to *disabled* and if the ETH0 or ETH1 LAN is selected by the *Backup Routes* system as the default route. (The selection algorithm is described in section 3.10). Since FW 5.3.0, *Default Gateway* and *DNS Server* are also supported on bridged interfaces (e.g., eth0 + eth1).

The following three items (in the table below) are global for the configured Ethernet interface. Only one bridge can be active on the router at a time. The *DHCP Client*, *IP Address*, and *Subnet Mask / Prefix* parameters of only one of the interfaces are used for the bridge. The ETH0 LAN has higher priority when both interfaces (ETH0 and ETH1) are added to the bridge. Other interfaces can be added to or removed from an existing bridge at any time. The bridge can be created on demand for such interfaces, but not if it is configured by their respective parameters.



Under certain conditions, the ETH interface may operate as a WAN interface, and the rules defined in the Firewall settings will be applied to it. Details are described in Chapter *Backup Routes* and are demonstrated with examples provided in that chapter.

Item	Description
Bridged	<p>Activates or deactivates the bridging function on the router.</p> <ul style="list-style-type: none"> • no – The bridging function is inactive (default). • yes – The bridging function is active. <p>See the Bridge Notes below the table for further details.</p>
Media Type	<p>Specifies the type of duplex and speed used in the network.</p> <ul style="list-style-type: none"> • Auto-negotiation – The router automatically sets the best speed and duplex mode of communication according to the network's possibilities. • 100 Mbps Full Duplex – The router communicates at 100 Mbps, in the full duplex mode. • 100 Mbps Half Duplex – The router communicates at 100 Mbps, in the half duplex mode. • 10 Mbps Full Duplex – The router communicates at 10 Mbps, in the full duplex mode. • 10 Mbps Half Duplex – The router communicates at 10 Mbps, in the half duplex mode.
MTU	Maximum Transmission Unit value. Default value is 1500 bytes.
LAN1 PoE PSE ¹ LAN2 PoE PSE ¹ LAN3 PoE PSE ¹ LAN4 PoE PSE ¹	<ul style="list-style-type: none"> • enabled – The PoE PSE feature is enabled for port LANx of an ETH0 interface. • disabled – The PoE PSE feature is disabled for port LANx of an ETH0 interface (default).

Table 15: Configuration of the Network Interface – Global Items

Bridge Notes

A bridge behaves like a network switch, forwarding packets between interfaces that are connected to it. The Advantech router supports creating a bridge network within Ethernet interfaces or between Ethernet interfaces and Wi-Fi Access Point (AP) interfaces. Once the bridge is configured and established, a new interface named `br0` is created. This interface will appear in the *Status* → *Network* → *Interfaces* section.

If a bridge is configured on two Ethernet interfaces, the `br0` interface will inherit the IP address of the Ethernet interface with the lower index. IP address and subnet configuration of the Ethernet interface with the higher index will be removed. This behavior is consistent regardless of the order in which the interfaces are configured.

To include a Wi-Fi AP interface in the bridge, at least one Ethernet interface must also be part of the bridge configuration. In this case, the IP address of the bridge interface `br0` will again be determined by the Ethernet interface (or interfaces) with the lowest index.

¹Available only on models equipped with the PoE PSE functionality.

3.1.1 DHCP Server

The DHCP server assigns the IP address, gateway IP address (IP address of the router) and IP address of the DNS server (IP address of the router) to the connected clients. If these values are filled in by the user in the configuration form, they will be preferred.

The DHCP server supports static and dynamic assignment of IP addresses. *Dynamic DHCP* assigns clients IP addresses from a defined address space. *Static DHCP* assigns IP addresses that correspond to the MAC addresses of connected clients.



If IPv6 column is filled in, the DHCPv6 server is used. DHCPv6 server offers stateful address configuration to connected clients. Only when the *Subnet Prefix* above is set to 64, the DHCPv6 server offers both – the stateful address configuration and SLAAC (Stateless Address Autoconfiguration).



For DHCPv6 static address assignment to work, DHCPv6 client must use DUID-LL or DUID-LLT types that are derived from its MAC address.



Do not to overlap ranges of static allocated IP addresses with addresses allocated by the dynamic DHCP server. IP address conflicts and incorrect network function can occur if you overlap the ranges.

Item	Description
Enable dynamic DHCP leases	Select this option to enable a dynamic DHCP server.
IP Pool Start	Starting IP address allocated to DHCP clients. Use proper notation in the IPv4 and IPv6 columns.
IP Pool End	Ending IP address allocated to DHCP clients. Use proper IP address notation in the IPv4 and IPv6 columns.
Lease Time	Duration (in seconds) for which the assigned IP address remains valid before it can be reassigned.

Table 16: Configuration of the Dynamic DHCP Server

Item	Description
Enable static DHCP leases	Select this option to enable a static DHCP server. You can define up to thirty-two rules. A new row for defining the next rule appears automatically after filling in the previous one.
MAC Address	MAC address of a DHCP client.
IPv4 Address	Assigned IPv4 address. Use proper notation.
IPv6 Address	Assigned IPv6 address. Use proper notation.

Table 17: Configuration of Static DHCP Server

3.1.2 IPv6 Prefix Delegation



This is an advanced configuration option. IPv6 prefix delegation works automatically with DHCPv6 – use only if different configuration is desired and if you know the consequences.

If you want to override the automatic IPv6 prefix delegation, you can configure it in this form. You have to know your Subnet ID Width (part of IPv6 address), see Figure below for the calculation help – it is an example: 48 bits is Site Prefix, 16 bits is Subnet ID (*Subnet ID Width*) and 64 bits is Interface ID.

2001:0db8:85a3:08d3:1319:8a2e:0370:7344

Site Prefix Subnet ID Interface ID

Figure 13: IPv6 Address with Prefix Example

Item	Description
Enable IPv6 prefix delegation	Enables prefix delegation configuration filled-in below.
Subnet ID	The decimal value of the Subnet ID of the Ethernet interface. Maximum value depends on the <i>Subnet ID Width</i> .
Subnet ID Width	The maximum <i>Subnet ID Width</i> depends on your Site Prefix – it is the remainder to 64 bits.

Table 18: IPv6 Prefix Delegation Configuration

3.1.3 802.1X Authentication to RADIUS Server

IEEE 802.1X is an **IEEE Standard** for **port-based Network Access Control** (PNAC), part of the IEEE 802.1 group of networking protocols. It provides an **authentication mechanism** for devices wishing to attach to a LAN or WLAN through "EAP over LAN" or **EAPoL**, which encapsulates the **Extensible Authentication Protocol** (EAP) over IEEE 802.

IEEE 802.1X authentication involves three parties: **a supplicant, an authenticator, and an authentication server**, illustrated in Figure 14.

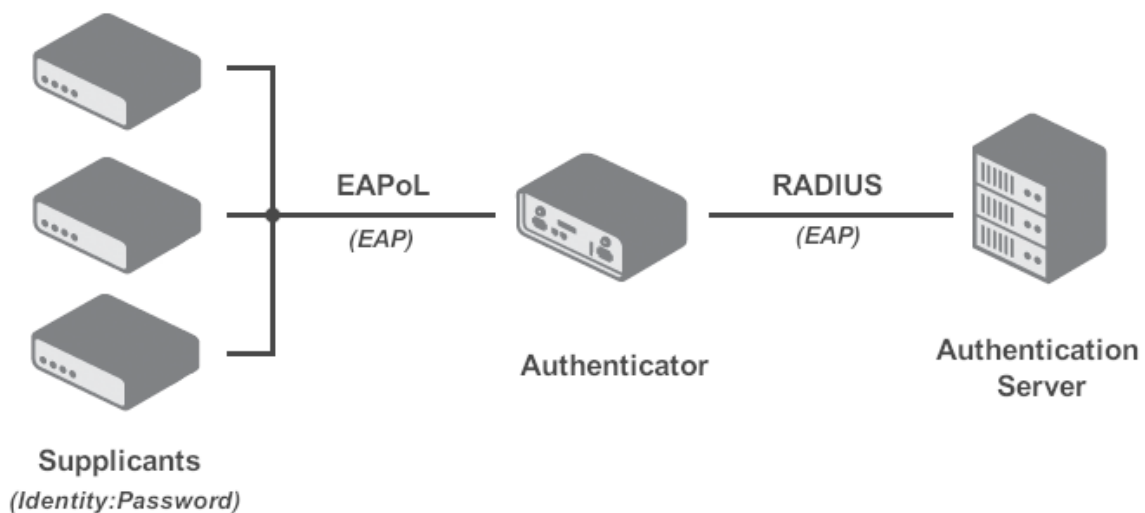

Figure 14: IEEE 802.1X Functional Diagram

- The **supplicant** is a client device (e.g., a laptop) wishing to attach to the LAN/WLAN, also referring to the client software providing credentials to the authenticator.
- The **authenticator** is a network device facilitating the data link between the supplicant and the network, capable of permitting or denying network traffic. This device communicates with the authentication server to decide on network access authorization for a supplicant.
- The **authentication server**, usually a trusted server, handles requests for network access, informing the authenticator about connection permissions and the settings applicable to the client's connection. It commonly runs software supporting the **RADIUS** and **EAP protocols**.

Table 19 summarizes the supported roles and cases for IEEE 802.1X authentication on Advantech routers.



Advantech routers support the roles of supplicant and authenticator only. The authentication server role is not supported.

Interface	Supplicant Role	Authenticator Role
LAN	As a built-in feature, configure LAN with 802.1X authentication, see Chapter 3.1.3.	While not a built-in feature, it can be facilitated by the <i>802.1X Authenticator</i> Router App.
WiFi	In Station (STA) mode, see Chapter 3.9.	In Access Point (AP) mode, see Chapter 3.8.

Table 19: Supported Roles for IEEE 802.1X Authentication

Authentication (802.1X) to RADIUS server can be enabled in next configuration section. This functionality requires additional setting of identity and certificates as described in the following table.

Item	Description
Enable IEEE 802.1X Authentication	Select this option to enable 802.1X Authentication.
Authentication Method	Select authentication method (EAP-PEAPMSCHAPv2 or EAP-TLS).
CA Certificate	Definition of CA certificate for EAP-TLS authentication protocol.
Local Certificate	Definition of local certificate for EAP-TLS authentication protocol.
Local Private Key	Definition of local private key for EAP-TLS authentication protocol.
Identity	User name – identity.
Password	Access password. This item is available for EAP-PEAPMSCHAPv2 protocol only. Enter valid characters only, see chap. 1.2.1.
Local Private Key Password	Definition of password for private key of EAP-TLS protocol. This item is available for EAP-TLS protocol only. Enter valid characters only, see chap. 1.2.1.

Table 20: Configuration of 802.1X Authentication

3.1.4 LAN Configuration Examples

Example 1: IPv4 Dynamic DHCP Server, Default Gateway and DNS Server

- The range of dynamic allocated IPv4 addresses is from 192.168.1.2 to 192.168.1.4.
- The address is allocated for 600 second (10 minutes).
- Default gateway IP address is 192.168.1.20
- DNS server IP address is 192.168.1.20

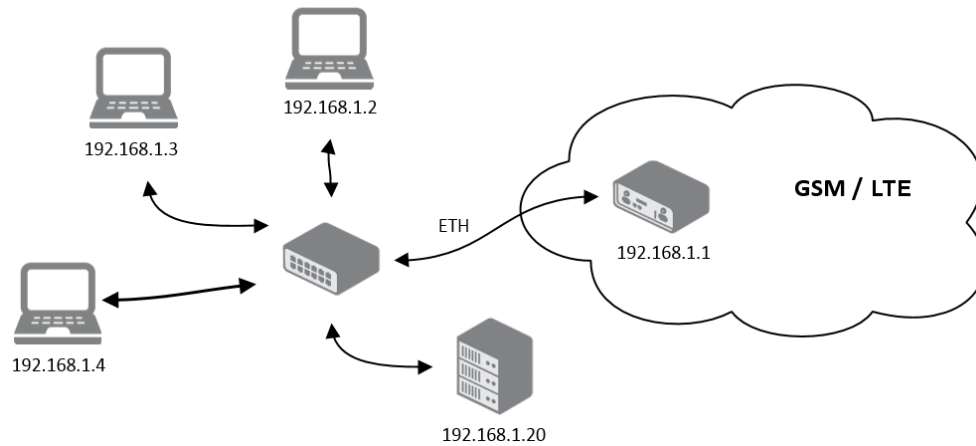

Figure 15: Network Topology for Example 1

ETH0 Configuration			
	IPv4	IPv6	
DHCP Client	disabled ▼	disabled ▼	
IP Address	192.168.1.1		
Subnet Mask / Prefix	255.255.255.0		
Default Gateway	129.168.1.20		
Primary DNS Server	192.168.1.20		
Secondary DNS Server			
Bridged	no ▼		
Media Type	auto-negotiation ▼		
<input checked="" type="checkbox"/> Enable dynamic DHCP leases			
IP Pool Start	192.168.1.2		
IP Pool End	192.168.1.4		
Lease Time	600	600 sec	
<input type="checkbox"/> Enable static DHCP leases			
	MAC Address	IP Address IPv6 Address	
1			
2			
Maximum 32 items			
<input type="checkbox"/> Enable IPv6 prefix delegation			
Subnet ID *			
Subnet ID Width *		bits	
<input type="checkbox"/> Enable IEEE 802.1X Authentication			
Authentication Method	EAP-PEAP/MSCHAPv2 ▼		
CA Certificate	<input type="text"/> <input type="button" value="Choose File"/> No file chosen		
Local Certificate	<input type="text"/> <input type="button" value="Choose File"/> No file chosen		
Local Private Key	<input type="text"/> <input type="button" value="Choose File"/> No file chosen		
Identity	<input type="text"/>		
Password	<input type="password"/>		
* can be blank			
<input type="button" value="Apply"/>			

Figure 16: LAN Configuration for Example 1

Example 2: IPv4 Dynamic and Static DHCP server

- The range of allocated addresses is from 192.168.1.2 to 192.168.1.4.
- The address is allocated for 600 seconds (10 minutes).
- The client with the MAC address 01:23:45:67:89:ab has the IP address 192.168.1.10.
- The client with the MAC address 01:54:68:18:ba:7e has the IP address 192.168.1.11.

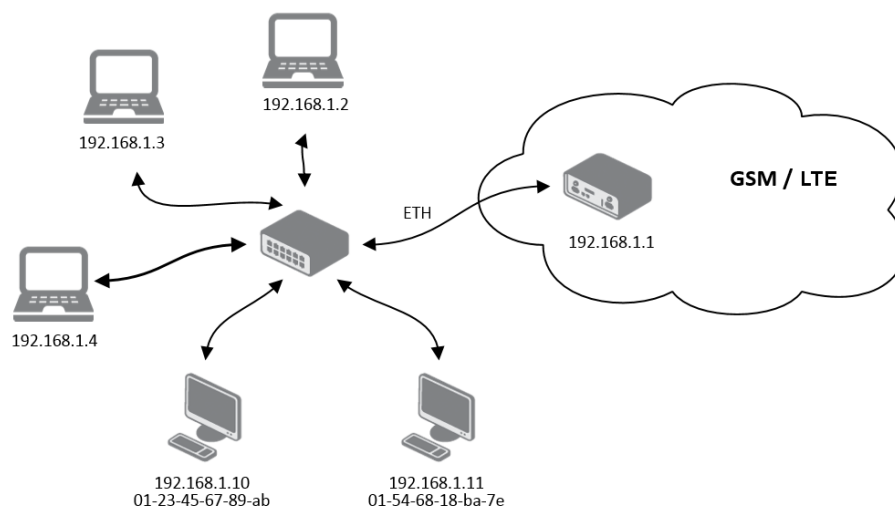

Figure 17: Network Topology for Example 2

ETH0 Configuration			
	IPv4	IPv6	
DHCP Client	disabled	disabled	
IP Address	192.168.1.1		
Subnet Mask / Prefix	255.255.255.0		
Default Gateway			
Primary DNS Server			
Secondary DNS Server			
Bridged	no		
Media Type	auto-negotiation		
<input checked="" type="checkbox"/> Enable dynamic DHCP leases			
	IPv4	IPv6	
IP Pool Start	192.168.1.2		
IP Pool End	192.168.1.4		
Lease Time	600	600	sec
<input checked="" type="checkbox"/> Enable static DHCP leases			
	MAC Address	IP Address	IPv6 Address
1	01:23:45:67:89:ab	192.168.1.10	
2	01:54:68:18:ba:7e	192.168.1.11	
Maximum 32 items			
<input type="checkbox"/> Enable IPv6 prefix delegation			
Subnet ID *			
Subnet ID Width *		bits	
<input type="checkbox"/> Enable IEEE 802.1X Authentication			
Authentication Method	EAP-TLS		
CA Certificate	<input type="text"/> <input type="button" value="Choose File"/> No file chosen		
Local Certificate	<input type="text"/> <input type="button" value="Choose File"/> No file chosen		
Local Private Key	<input type="text"/> <input type="button" value="Choose File"/> No file chosen		
Identity	<input type="text"/>		
Local Private Key Password	<input type="password"/>		
* can be blank			
<input type="button" value="Apply"/>			

Figure 18: LAN Configuration for Example 2

Example 3: IPv6 Dynamic DHCP Server

- The range of dynamic allocated IPv6 addresses is from 2001:db8::1 to 2001:db8::ffff.
- The address is allocated for 600 second (10 minutes).
- The router is still accessible via IPv4 (192.168.1.1).

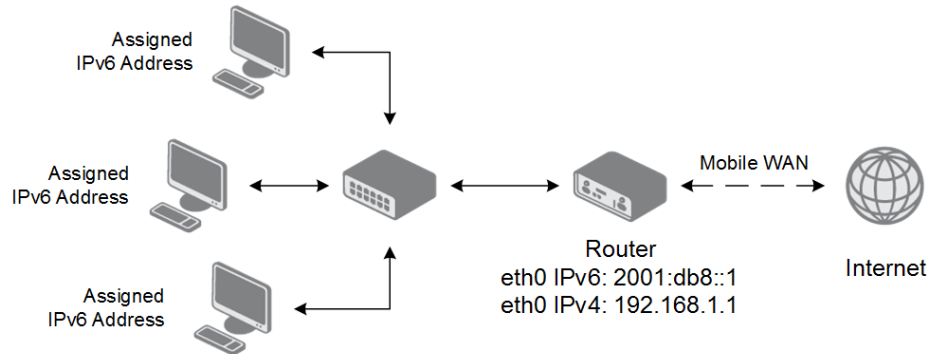

Figure 19: Network Topology for Example 3

ETH0 Configuration			
DHCP Client	IPv4	IPv6	
	disabled	disabled	
IP Address	192.168.1.1	2001:db8::1	
Subnet Mask / Prefix	255.255.255.0	64	
Default Gateway			
Primary DNS Server			
Secondary DNS Server			
Bridged	no		
Media Type	auto-negotiation		
<input checked="" type="checkbox"/> Enable dynamic DHCP leases			
IP Pool Start	IPv4	IPv6	
		2001:db8::2	
IP Pool End		2001:db8::ffff	
Lease Time		600	sec
<input type="checkbox"/> Enable static DHCP leases			
	MAC Address	IP Address	IPv6 Address
1			
2			
Maximum 32 items			
<input type="checkbox"/> Enable IPv6 prefix delegation			
Subnet ID *			
Subnet ID Width *		bits	
<input type="checkbox"/> Enable IEEE 802.1X Authentication			
Authentication Method	EAP-TLS		
CA Certificate			
	Choose File	No file chosen	
Local Certificate			
	Choose File	No file chosen	
Local Private Key			
	Choose File	No file chosen	
Identity			
Local Private Key Password			
* can be blank			
Apply			

Figure 20: LAN Configuration for Example 3

3.2 VLAN

This section provides options for configuring VLANs on the device. You can configure up to three VLANs. The configuration form consists of multiple sections that allow you to set up VLAN interfaces, manage DHCP leases, and configure IPv6 delegation. See Figure 21 and Table 21 for details.

1st VLAN Configuration

Create 1st VLAN connection

	IPv4	IPv6
DHCP Client	<input type="text" value="disabled"/>	<input type="text" value="disabled"/>
IP Address	<input type="text"/>	<input type="text"/>
Subnet Mask / Prefix	<input type="text"/>	<input type="text"/>

Interface

VLAN ID

MTU * bytes

Enable dynamic DHCP leases

	IPv4	IPv6
IP Pool Start	<input type="text"/>	<input type="text"/>
IP Pool End	<input type="text"/>	<input type="text"/>
Lease Time	<input type="text" value="600"/>	<input type="text" value="600"/> sec

Enable static DHCP leases

	MAC Address	IP Address	IPv6 Address
1	<input type="text"/>	<input type="text"/>	<input type="text"/>
2	<input type="text"/>	<input type="text"/>	<input type="text"/>

Maximum 32 items

Enable IPv6 prefix delegation

Subnet ID *

Subnet ID Width * bits

* can be blank

Figure 21: VLAN Configuration Form

Item	Description
Create VLAN connection	Enables VLAN creation.
DHCP Client (IPv4/IPv6)	Enables or disables the DHCP client for IPv4 and IPv6: <ul style="list-style-type: none"> • Disabled — Disables the DHCP client. • Enabled — Enables the DHCP client for the respective protocol.
IP Address	Manually specifies the IP address for the VLAN interface.
Subnet Mask / Prefix	Defines the subnet mask for IPv4 or the prefix length for IPv6.
Interface	Selects the Ethernet interface associated with the VLAN.
VLAN ID	Specifies the VLAN ID for the virtual LAN interface.
MTU	Defines the Maximum Transmission Unit (MTU) size in bytes.

Continued on the next page

Continued from previous page

Item	Description
Enable dynamic DHCP leases	Configures dynamic DHCP leases for IPv4 and IPv6. <ul style="list-style-type: none"> • IP Pool Start: Defines the starting IP address of the DHCP pool. • IP Pool End: Defines the ending IP address of the DHCP pool. • Lease Time: Specifies the lease duration in seconds (default: 600 seconds).
Enable static DHCP leases	Configures static DHCP leases for specific MAC addresses. You can define up to thirty-two rules for each. A new row for defining the next rule appears automatically after filling in the previous one. <ul style="list-style-type: none"> • MAC Address: Specifies the MAC address of the client. • IP Address: Assigns a fixed IPv4 address to the client. • IPv6 Address: Assigns a fixed IPv6 address to the client.
Enable IPv6 prefix delegation	Configures IPv6 prefix delegation: <ul style="list-style-type: none"> • Subnet ID: Specifies the subnet ID for prefix delegation. • Subnet ID Width: Defines the width of the subnet ID in bits.

Table 21: VLAN Configuration Options

3.3 VRRP

Select the *VRRP* menu item to enter the VRRP configuration. There are two submenus allowing the configuration of up to two VRRP instances. The VRRP protocol (Virtual Router Redundancy Protocol) enables packet routing to be transferred from the primary router to a backup router in case of a failure. This can be useful for providing a cellular backup to a primary wired router in critical applications. If the *Enable VRRP* option is checked, you can configure the following parameters:

Item	Description
Protocol Version	Select the VRRP version (VRRPv2 or VRRPv3).
Interface	Select the interface to be used for VRRP communication.
Virtual Server IP Address	Sets the virtual server IP address, which must be the same for both the primary and backup routers. Devices on the LAN will use this address as their default gateway.
Virtual Server ID	Identifies the virtual router on the network. The primary and backup routers must use the same value.
Host Priority	Determines which router is the primary. The router with the highest priority (set by the <i>Host Priority</i> parameter) becomes the main router. According to RFC 2338, the primary router should have the highest possible priority (255). Backup routers should have a priority value between 1 and 254 (default: 100). A priority value of 0 is not allowed.

Table 22: VRRP Configuration Items Description

In the second section of the configuration window, you can enable the *Check connection* option to allow automatic test messages for the cellular network. In some cases, the mobile WAN connection may appear active, but the router might be unable to transmit data over the cellular network. This feature helps verify whether data can be sent over the PPP connection, complementing the standard VRRP message handling.

The currently active router (primary/backup) will send test messages (Ping) to the specified *Ping IP Address* at periodic intervals (*Ping Interval*) and wait for a response (*Ping Timeout*). If no response is received, the router will retry up to the number of times specified by the *Ping Probes* parameter. If all attempts fail, the router will switch to backup mode until the PPP connection is restored.



You may use the DNS server of the mobile carrier as the destination IP address for test messages (Pings).

The *Enable traffic monitoring* option helps reduce unnecessary test messages for verifying the PPP connection. When this option is enabled, the router will monitor the interface for non-ping traffic. If a response to another type of packet is received within the *Ping Timeout* period, the router assumes the connection is still active. If no response is received within this period, the router will initiate standard Ping tests to check the mobile WAN connection.

Item	Description
Ping IP Address	Destination IP address for Ping commands. The IP address cannot be specified as a domain name.
Ping Interval	Interval, in seconds, between outgoing Ping requests.
Ping Timeout	Time, in seconds, to wait for a response to a Ping request.
Ping Probes	Maximum number of consecutive failed Ping requests before considering the connection as down.

Table 23: Check Connection Parameters

3.3.1 VRRP Usage Example

In this example, VRRP is configured on two routers to ensure high availability and minimize downtime for network clients. Figure illustrates the overall topology, where both routers share a virtual IP address. The main router is configured with a higher priority, while the backup router has a lower priority. Should the main router fail or become unreachable, the backup router automatically takes over as the default gateway, preventing service disruption.

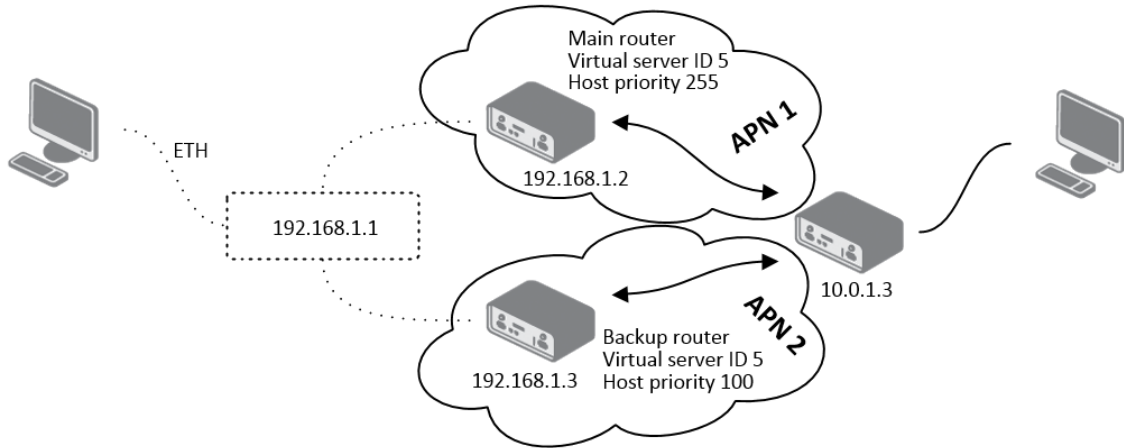

Figure 22: VRRP Configuration Example Topology

1st VRRP Instance Configuration	
<input checked="" type="checkbox"/> Enable 1st VRRP Instance	
Protocol Version	VRRPv2
Interface	ETH0
Virtual Server IP Address	192.168.1.1
Virtual Server ID	5
Host Priority	255
<input checked="" type="checkbox"/> Check connection	
Ping IP Address	10.0.1.3
Ping Interval	10 sec
Ping Timeout	5 sec
Ping Probes	10
<input type="checkbox"/> Enable traffic monitoring	
Apply	

Figure 23: Main Router Configuration

1st VRRP Instance Configuration	
<input checked="" type="checkbox"/> Enable 1st VRRP Instance	
Protocol Version	VRRPv2
Interface	ETH0
Virtual Server IP Address	192.168.1.1
Virtual Server ID	5
Host Priority	100
<input checked="" type="checkbox"/> Check connection	
Ping IP Address	10.0.1.3
Ping Interval	10 sec
Ping Timeout	5 sec
Ping Probes	10
<input type="checkbox"/> Enable traffic monitoring	
Apply	

Figure 24: Backup Router Configuration

3.4 Mobile WAN Configuration

Select the *Mobile WAN* item in the *Configuration* menu section to enter the cellular network configuration pages. The menu item will expand and you will see three separate configuration pages: *1st module*, *2nd module* and *Module Switching*. The last page – *Module Switching* – is the most important in the hierarchy of decision making when connecting to a mobile network. See the Figure below for help on where to configure decision making for each module and SIM card. The decision concerning which SIM card is used is calculated by the logical outcome of the system and the individual settings of each module and SIM card. The subpages of Mobile WAN are explained below in order of appearance on the menu.

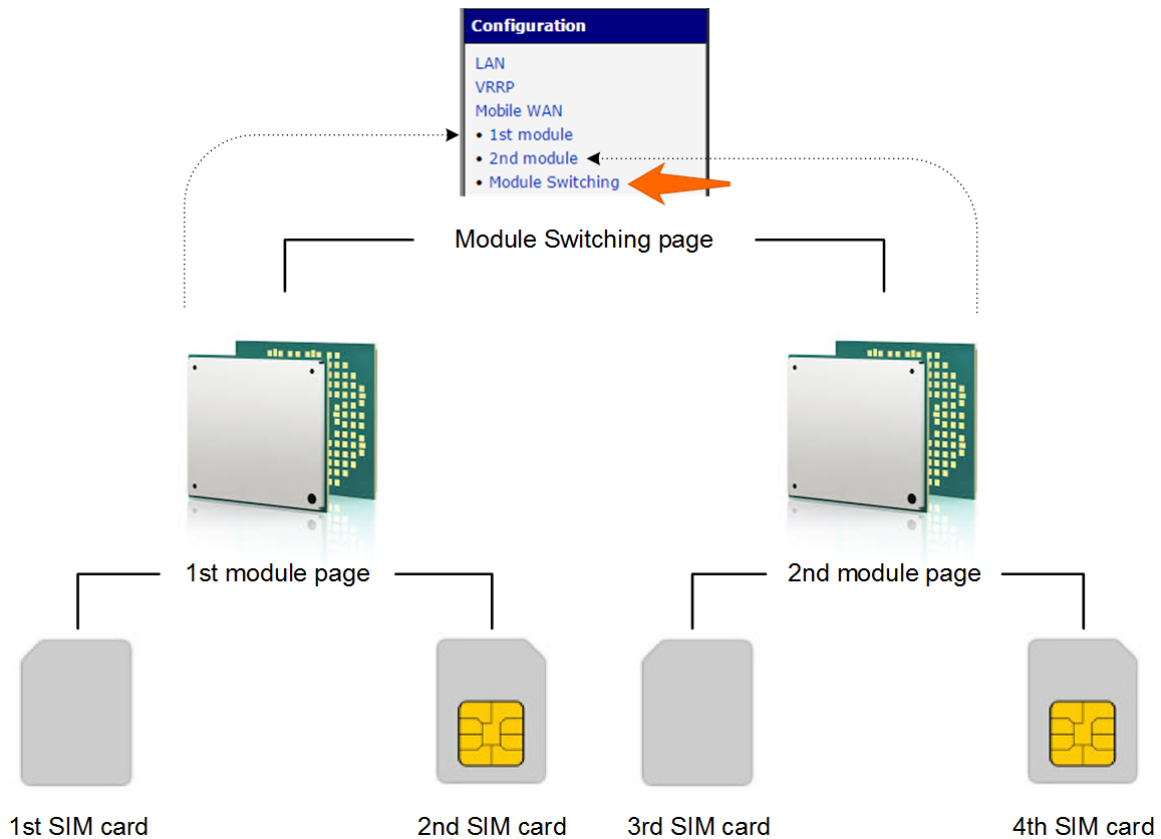

Figure 25: Switching and configuration pages structure

3.5 1st and 2nd Mobile WAN Configuration

To configure the 1st cellular module and 1st and 2nd SIM cards – go to the *1st module* configuration page, as shown in Figure 27 below. The configuration settings of the 2nd cellular module, and 3rd and 4th SIM cards are under the *2nd module* page, which has exactly the same configuration items and options as *1st module* page.

3.5.1 Connection to Mobile Network

If the *Create connection to mobile network* checkbox is checked, then the router will automatically attempt to establish a connection after booting up. You can specify the following parameters for each SIM card separately.

Item	Description
APN	Network identifier (Access Point Name).
Username	The user name used for logging on to the GSM network.
Password	The password used for logging on to the GSM network. Enter valid characters only, see chap. 1.2.1.
Authentication	Authentication protocol used in the GSM network: <ul style="list-style-type: none"> • PAP or CHAP – The router selects the authentication method. • PAP – The router uses the PAP authentication method. • CHAP – The router uses the CHAP authentication method.
IP Mode	Specifies the version of IP protocol used: <ul style="list-style-type: none"> • IPv4 – IPv4 protocol is used only (default). • IPv6 – IPv6 protocol is used only. • IPv4/IPv6 – IPv4 and IPv6 independent dual stack is enabled.
IP Address	For use in IPv4 and IPv4/IPv6 mode only. Specifies the IPv4 address of the SIM card. You manually enter the IP address only when mobile network carrier has assigned the IP address.
Dial Number	Specifies the telephone number which the router dials for a GPRS or CSD connection. The router uses the default telephone number *99***1 #.
Operator	Specifies the carrier code. You can specify this parameter as the PLNM preferred carrier code.
Network type	Specifies the type of protocol used in the mobile network. <ul style="list-style-type: none"> • Automatic selection – The router automatically selects a transmission method according to the availability of transmission technologies. • It is also possible to select one of the following specific methods of data transmission: LTE, UMTS/HSPA, GPRS/EDGE.
PIN	Specifies the PIN used to unlock the SIM card. Use only if this is required by a given SIM card. The SIM card will be blocked after several failed attempts to enter the PIN.
MRU	Maximum Receive Unit – maximum size of packet that the router can receive via Mobile WAN. The default value is 1500 B. Other settings may cause the router to receive data incorrectly. Minimal value in IPv4 and IPv4/IPv6 mode is 128 B. Minimal value in IPv6 mode is 1280 B.
MTU	Maximum Transmission Unit – maximum size of packet that the router can transmit via Mobile WAN. The default value is 1500 B. Other settings may cause the router to transmit data incorrectly. Minimal value in IPv4 and IPv4/IPv6 mode is 128 B. Minimal value in IPv6 mode is 1280 B.

Table 24: Mobile WAN Connection Configuration



The following is a list of tips for working with the *1st/2nd Mobile WAN Configuration* form:

- If the MTU size is set incorrectly, then the router will not exceed the data transfer. If the MTU value is set too low, more frequent fragmentation of data will occur. More frequent fragmentation will mean a higher overhead and also the possibility of packet damage during defragmentation. In contrast, a higher MTU value can cause the network to drop the packet.
- If the *IP address* field is left blank, when the router establishes a connection, the mobile network carrier will automatically assign an IP address. If you assign an IP address manually, then the router will access the network quicker.
- If the **APN** field is left blank, the router automatically selects the APN using the IMSI code of the SIM card. The name of the chosen APN can be found in the System Log.
- If you enter the word *blank* in the *APN* field, then the router interprets the APN as blank.



The correct PIN must be filled in. An incorrect PIN may block the SIM card.

Parameters identified with an asterisk require you to enter the appropriate information only if this information is required by the mobile network carrier.

When the router is unsuccessful in establishing a connection to mobile network, you should verify accuracy of the entered data. Alternatively, you could try a different authentication method or network type.

3.5.2 DNS Address Configuration

The *DNS Settings* parameter is designed for easier configuration on the client's side. When this value is set to *get from operator* the router will attempt to automatically obtain an IP address from the primary and secondary DNS server of the mobile network carrier. To specify the IP addresses of the Primary DNS servers manually, on the *DNS Server* pull down list select the value *set manually*. You can also fill-in the IPv4 or IPv6 address of the DNS server (or both) based on the IP Mode option.

3.5.3 Check Connection to Mobile Network



Enabling the *Check Connection* function for mobile networks is necessary for uninterrupted and continuous operation of the router.

If the *Check Connection* item is set to *enabled* or *enabled + bind*, the router will be sending the ping requests to the specified domain or IP address configured in *Ping IP Address* or *Ping IPv6 Address* at regular time intervals set up in the *Ping Interval*.

In case of an unsuccessful ping, a new ping will be sent after the *Ping Timeout*. If the ping is unsuccessful three times in a row, the router will terminate the cellular connection and will attempt to establish a new one.

This monitoring function can be set for both SIM cards separately, but running on the active SIM at given time only. Be sure, you configure a functional address as the destination for the ping, for example an IP address of the operator's DNS server.

If the *Check Connection* item is set to the *enabled*, the ping requests are being sent on the basis of the routing table. Therefore, the requests may be sent through any available interface. If you require each ping request to be sent through the network interface, which was created when establishing a connection to the mobile operator, it is necessary to set the *Check Connection* to *enabled + bind*. The *disabled* option deactivates checking of the connection to the mobile network.



A note for routers connected to the **Verizon** carrier (detected by the router):
 The retry interval for connecting to the mobile network prolongs with more retries. First two retries are done after 1 minute. Then the interval prolongs to 2, 8 and 15 minutes. The ninth and every other retry is done in 90 minutes interval.

If *Enable Traffic Monitoring* item is checked, the router will monitor the Mobile WAN traffic without sending the ping requests. If there is no traffic, the router will start sending the ping requests.

Item	Description
Ping IP Address	Specifies the ping queries destination IPv4 address or domain name. Available in IPv4 and IPv4/IPv6 <i>IP Mode</i> .
Ping IPv6 Address	Specifies the ping queries destination IPv6 address or domain name. Available in IPv6 and IPv4/IPv6 <i>IP Mode</i> .
Ping Interval	Specifies the time interval between outgoing pings.
Ping Timeout	Time in seconds to wait for a Ping response.

Table 25: Check Connection to Mobile Network Configuration

3.5.4 Check Connection Example

The figure below displays the following scenario: the connection to the mobile network in IPv4 *IP Mode* is controlled on the address 8.8.8.8 with a time interval of 60 seconds for the first SIM card and on the address www.google.com with the time interval 80 seconds for the second SIM card (for an active SIM only). Because the *Enable traffic monitoring* option is enabled, the control pings are not sent, but the data stream is monitored. The ping will be sent, if the data stream is interrupted.

(The feature of check connection to mobile network is necessary for uninterrupted operation)

Check Connection	<input type="text" value="enabled"/>	<input type="text" value="enabled"/>
Ping IP Address	<input type="text" value="8.8.8.8"/>	<input type="text" value="www.google.com"/>
Ping IPv6 Address	<input type="text"/>	<input type="text"/>
Ping Interval	<input type="text" value="60"/>	<input type="text" value="80"/> sec
Ping Timeout	<input type="text" value="10"/>	<input type="text" value="10"/> sec

Enable traffic monitoring

Figure 26: Check Connection Example

3.5.5 Data Limit Configuration

Item	Description
Data Limit	Specifies the maximum expected amount of data transmitted (sent and received) over GPRS in one billing period (one month). Maximum value is 2 TB (2097152 MB).
Warning Threshold	Specifies a percentage of the "Data Limit" in the range of 50 % to 99 %. If the given percentage data limit is exceeded, the router will send an SMS in the following form; <i>Router has exceeded (value of Warning Threshold) of data limit.</i>
Accounting Start	Specifies the day of the month in which the billing cycle starts for a given SIM card. When the service provider that issued the SIM card specifies the start of the billing period, the router will begin to count the amount of data transferred starting on this day.

Table 26: Data Limit Configuration



If the parameter *Data Limit State* (see below) is set to *not applicable* or *Send SMS when data limit is exceeded* in *SMS Configuration* is not selected, the *Data Limit* set here will be ignored.

3.5.6 Switch between SIM Cards Configuration

In the lower part of the *1st (2nd) Mobile WAN Configuration* page you can specify the rules for toggling between the two SIM cards.



The router will automatically toggle between the SIM cards and their individual setups depending on the configuration settings specified here (manual permission, roaming, data limit, binary inputs state). Note that the SIM card selected for connection establishment is the result of the logical product (AND) of the configuration here (table below).

Item	Description
SIM Card	<p>Enable or disable the use of a SIM card. If you set all the SIM cards to <i>disabled</i>, this means that the entire cellular module is disabled.</p> <ul style="list-style-type: none"> • enabled – It is possible to use the SIM card. • disabled – Never use the SIM card, the usage of this SIM is forbidden.
Roaming State	<p>Configure the use of SIM cards based on roaming. This roaming feature has to be activated for the SIM card on which it is enabled!</p> <ul style="list-style-type: none"> • not applicable – It is possible to use the SIM card everywhere. • home network only – Only use the SIM card if roaming is not detected.
Data Limit State	<p>Configure the use of SIM cards based on the Data Limit set above:</p> <ul style="list-style-type: none"> • not applicable – It is possible to use the SIM regardless of the limit. • not exceeded – Use the SIM card only if the Data Limit (set above) has not been exceeded.
BIN0 State	<p>Configure the use of SIM cards based on binary input 0 state:</p> <ul style="list-style-type: none"> • not applicable – It is possible to use the SIM regardless of BIN0 state. • on – Only use the SIM card if the BIN0 state is logical 0 – voltage present. • off – Only use the SIM card if the BIN0 state is logical 1 – no voltage.
BIN1 State	<p>Configure the use of SIM cards based on binary input 1 state:</p> <ul style="list-style-type: none"> • not applicable – It is possible to use the SIM regardless of BIN1 state. • on – Only use the SIM card if the BIN1 state is logical 0 – voltage present. • off – Only use the SIM card if the BIN1 state is logical 1 – no voltage.

Table 27: Switch between SIM cards configuration

Use the following parameters to specify the decision making of SIM card switching in a particular cellular module.

Item	Description
Default SIM Card	Specifies the modules' default SIM card. The router will attempt to establish a connection to mobile network using this default. <ul style="list-style-type: none"> • 1st (3rd) – The 1st (3rd) SIM card is the default one. • 2nd (4th) – The 2nd (4th) SIM card is the default one.
Initial State	Specifies the action of the cellular module after the SIM card has been selected. <ul style="list-style-type: none"> • online – establish connection to the mobile network after the SIM card has been selected (default). • offline – go to the off-line mode after the SIM card has been selected. <p>Note: If offline, you can change this initial state by SMS message only – see <i>SMS Configuration</i>. The cellular module will also go into off-line mode if none of the SIM cards are not selected.</p>
Switch to other SIM card when connection fails	Applicable only when connection is established on the default SIM card and then fails. If the connection failure is detected by <i>Check Connection</i> feature above, the router will switch to the backup SIM card.
Switch to default SIM card after timeout	If enabled, after timeout, the router will attempt to switch back to the default SIM card. This applies only when there is default SIM card defined and the backup SIM is selected because of a failure of the default one or if roaming settings cause the switch. This feature is available only when <i>Switch to other SIM card when connection fails</i> is enabled.
Initial Timeout	Specifies the length of time that the router waits before the first attempt to revert to the default SIM card, the range of this parameter is from 1 to 10000 minutes.
Subsequent Timeout	Specifies the length of time that the router waits after an unsuccessful attempt to revert to the default SIM card, the range is from 1 to 10000 min.
Additive Constant	Specifies the length of time that the router waits for any further attempts to revert to the default SIM card. This length time is the sum of the time specified in the "Subsequent Timeout" parameter and the time specified in this parameter. The range in this parameter is from 1 to 10000 minutes.

Table 28: Parameters for SIM card switching

 The cellular module will go into *offline* mode if no SIM card can be selected. In off-line mode, the *Default SIM card* is selected and the manual change of SIM card is possible via SMS only, see *SMS Configuration* in Chapter 3.20.8.

1st Mobile WAN Configuration			
<input checked="" type="checkbox"/> Create connection to mobile network			
	1st SIM card	2nd SIM card	
APN *	advantech.agnep.cz		
Username *			
Password *			
Authentication	PAP or CHAP ▼	PAP or CHAP ▼	
IP Mode	IPv4 ▼	IPv4 ▼	
IP Address *			
Dial Number *			
Operator *			
Network Type	automatic selection ▼	automatic selection ▼	
PIN *			
MRU	1500	1500	bytes
MTU	1500	1500	bytes
DNS Settings	get from operator ▼	get from operator ▼	
DNS IP Address			
DNS IPv6 Address			
<i>(The feature of check connection to mobile network is necessary for uninterrupted operation)</i>			
Check Connection	disabled ▼	disabled ▼	
Ping IP Address			
Ping IPv6 Address			
Ping Interval			sec
Ping Timeout	10	10	sec
<input type="checkbox"/> Enable traffic monitoring			
Data Limit			MB
Warning Threshold			%
Accounting Start	1	1	
SIM Card	enabled ▼	enabled ▼	
Roaming State	not applicable ▼	not applicable ▼	
Data Limit State	not applicable ▼	not applicable ▼	
BIN0 State	not applicable ▼	not applicable ▼	
BIN1 State	not applicable ▼	not applicable ▼	
Default SIM Card	1st ▼		
Initial State	online ▼		
<input type="checkbox"/> Switch to other SIM card when connection fails			
<input type="checkbox"/> Switch to default SIM card after timeout			
Initial Timeout	60		min
Subsequent Timeout *			min
Additive Constant *			min
<input type="checkbox"/> Enable PPPoE bridge mode			
* can be blank			
<input type="button" value="Apply"/>			

Figure 27: 1st Mobile WAN Configuration

3.5.7 Examples of SIM Card Switching Configuration

Example 1: Timeout Configuration

Mark the *Switch to default SIM card after timeout* check box, and fill-in the following values:

<input checked="" type="checkbox"/>	Switch to other SIM card when connection fails
<input checked="" type="checkbox"/>	Switch to default SIM card after timeout
Initial Timeout	<input type="text" value="60"/> min
Subsequent Timeout *	<input type="text" value="30"/> min
Additive Constant *	<input type="text" value="20"/> min

Figure 28: Configuration for SIM card switching Example 1

The first attempt to change to the default SIM card is carried out after 60 minutes. When the first attempt fails, a second attempt is made after 30 minutes. A third attempt is made after 50 minutes (30+20). A fourth attempt is made after 70 minutes (30+20+20).

Example 2: Data Limit Switching

The following configuration illustrates a scenario in which the router changes to the second SIM card after exceeding the data limit of 800 MB on the first (default) SIM card. The router sends SMS upon reaching 400 MB (this settings has to be enabled on the *SMS Configuration* page). The accounting period starts on the 18th day of the month.

Data Limit	<input type="text" value="800"/>	<input type="text"/>	MB
Warning Threshold	<input type="text" value="50"/>	<input type="text"/>	%
Accounting Start	<input type="text" value="18"/>	<input type="text"/>	
SIM Card	<input type="text" value="enabled"/>	<input type="text" value="enabled"/>	
Roaming State	<input type="text" value="not applicable"/>	<input type="text" value="not applicable"/>	
Data Limit State	<input type="text" value="not applicable"/>	<input type="text" value="not applicable"/>	
BIN0 State	<input type="text" value="not applicable"/>	<input type="text" value="not applicable"/>	
Default SIM Card	<input type="text" value="1st"/>		
Initial State	<input type="text" value="online"/>		
<input type="checkbox"/> Switch to other SIM card when connection fails <input type="checkbox"/> Switch to default SIM card after timeout			
Initial Timeout	<input type="text"/>		min
Subsequent Timeout *	<input type="text"/>		min
Additive Constant *	<input type="text"/>		min

Figure 29: Configuration for SIM card switching Example 2

3.6 Module Switching Configuration

On this page you can configure the main decision process of cellular module switching. The cellular module that is selected is the result of the logical product (AND function) of the decision-making settings of the configuration on this page.

Module Switching			
	1st module	2nd module	
Module	enabled ▼	enabled ▼	
BIN0 State	not applicable ▼	not applicable ▼	
BIN1 State	not applicable ▼	not applicable ▼	
Default Module	1st ▼		
Holdoff Time	<input type="text"/> sec		
<input type="checkbox"/> Switch to the other module when signal strength drops below "weak" level (and is above "fair" level on target module)			
	weak	fair	
Levels for GPRS/EDGE	<input type="text" value="-90"/>	<input type="text" value="-80"/>	dBm
Levels for UMTS/HSPA	<input type="text" value="-100"/>	<input type="text" value="-90"/>	dBm
Levels for LTE	<input type="text" value="-100"/>	<input type="text" value="-90"/>	dBm
Sampling Interval	<input type="text" value="10"/>	sec	
Filter Width	<input type="text" value="4"/>	/	<input type="text" value="16"/> samples
<input type="button" value="Apply"/>			

Figure 30: Module Switching Configuration

Item	Description
Module	Enable or disable the cellular module. If all the cellular modules are set to <i>disabled</i> , no connection to a cellular network is attempted. <ul style="list-style-type: none"> • enabled – It is possible to use the cellular module if the connection to the cellular network is successfully established. • disabled – Usage of the cellular module is forbidden, never use the cellular module.
BIN0 State	Cellular module usage based on binary input 0 state: <ul style="list-style-type: none"> • not applicable – Use the cellular module regardless of the BIN0 state. • on – Use the cellular module only if the BIN0 is logical 0 – voltage present. • off – Use the cellular module only if the BIN0 is logical 1 – no voltage.

Continued on next page

Continued from previous page

Item	Description
BIN1 State	Cellular module usage based on binary input 1 state: <ul style="list-style-type: none"> • not applicable – Use the cellular module regardless of the BIN1 state. • on – Use the cellular module only if the BIN1 is logical 0 – voltage present. • off – Use the cellular module only if the BIN1 is logical 1 – no voltage.
Default Module	Specifies the default cellular module. The router uses this default cellular module preferentially for connection to mobile network. <ul style="list-style-type: none"> • none – None cellular module is the default one. • 1st – The 1st cellular module is the default one. • 2nd – The 2nd cellular module is the default one.
Holdoff Time	If the default cellular module is de-selected because of a failed signal, the other cellular module is selected after this holdoff time, given in seconds. This is a protection against fast module switching. It applies only when the connection fails on the default module. Switches because of roaming, data limit, BIN or signal levels are performed immediately.
Switch to the other module when signal strength drops below the "weak" level (and is above "fair" level on target module)	This parameter enables automatic switching of cellular modules, when the signal strength of the active one drops below the specified value (and signal strength of the other one is above the specified value). The system will switch back to the default cellular module when the signal strength is below the "weak" level again and so on.
Levels for GPRS/EDGE	Signal strength limits for GPRS/EDGE technology.
Levels for UMTS/HSPA+	Signal strength limits for UMTS/HSPA+ technology.
Levels for LTE	Signal strength limits for LTE technology.
Sampling Interval	The period of sample taking when measuring the signal strength, given in seconds.
Filter Width	The width for calculating the moving average of loaded values of signal strength. The first value indicates the lowest number of loaded samples for which the value of a calculated average is valid and can be used to evaluate the relevant condition. The second value is a filter buffer width in the steady state when the moving average algorithm is applied (ie. if another sample is loaded, this replaces the oldest one, which means that the filter width remains constant).

Table 29: Module Switching Configuration

3.6.1 PPPoE Bridge Mode Configuration

If you mark the *Enable PPPoE bridge mode* check box on the configuration page for the first MWAN module, the router will activate the PPPoE bridge protocol. PPPoE (point-to-point over ethernet) is a network protocol for encapsulating Point-to-Point Protocol (PPP) frames inside Ethernet frames. This bridge mode allows you to create a PPPoE connection from a device behind the router. For example, a PC connected to the ETH port of the router. You assign the IP address of the SIM card to the PC.

 For **SmartMotion ST355** routers only: If you enable *PPPoE bridge mode*, it is not possible to use *SMS Configuration* features – the router will not send SMSs and you cannot control the router via SMS! The *Send SMS* feature in the *Administration* section will not work. Also in *Mobile WAN Status* there will be no signal strength data displayed. This is caused by the use of the same channel for sending AT commands in the cellular module in this version of the router. If the channel is occupied by AT commands for PPPoE bridge, there is no place for SMS AT commands.

The changes in settings will be applied after clicking the *Apply* button.

3.7 PPPoE

PPPoE (Point-to-Point over Ethernet) is a network protocol that encapsulates PPP frames into Ethernet frames. The router uses the PPPoE client to connect to devices supporting a PPPoE bridge or server. The bridge or server is typically an ADSL router.

To open the *PPPoE Configuration* page, select the *PPPoE* menu item. If you check the *Create PPPoE connection* box, the router will attempt to establish a PPPoE connection after boot-up. Once connected, the router obtains the IP address of the device to which it is connected. Communication from devices behind the PPPoE server is then forwarded to the router, enabling full network access.

PPPoE Configuration

Create PPPoE connection

Interface ▼

Username *

Password * 👁

Authentication ▼

IP Mode ▼

MRU bytes

MTU bytes

Clamp Max. Segment Size

DNS Settings ▼

Primary DNS Server

Primary IPv6 DNS Server

Secondary DNS Server

Secondary IPv6 DNS Server

* can be blank

Figure 31: PPPoE Configuration

Item	Description
Create PPPoE connection	Enable PPPoE on the selected interface.
Interface	Select an Ethernet interface for the PPPoE connection.
Username	Username for secure access to PPPoE.
Password	Password for secure access to PPPoE. Enter valid characters only, see chap. 1.2.1.

Continued on next page

Continued from previous page

Item	Description
Authentication	<p>Authentication protocol in the GSM network.</p> <ul style="list-style-type: none"> • PAP or CHAP – The router selects the authentication method. • PAP – The router uses the PAP authentication method. • CHAP – The router uses the CHAP authentication method.
IP Mode	<p>Specifies the version of the IP protocol:</p> <ul style="list-style-type: none"> • IPv4 – Only the IPv4 protocol is used (default). • IPv6 – Only the IPv6 protocol is used. • IPv4/IPv6 – Dual stack for both IPv4 and IPv6 is enabled.
MRU	<p>Specifies the Maximum Receive Unit. The MRU identifies the maximum packet size that the router can receive via PPPoE. The default value is 1492 B (bytes). Other settings may result in incorrect data transmission. The minimum value for IPv4 and IPv4/IPv6 mode is 128 B, and for IPv6 mode is 1280 B.</p>
MTU	<p>Specifies the Maximum Transmission Unit. The MTU identifies the maximum packet size that the router can transfer in a given environment. The default value is 1492 B (bytes). Other settings may result in incorrect data transmission. The minimum value for IPv4 and IPv4/IPv6 mode is 128 B, and for IPv6 mode is 1280 B.</p>
Clamp Max. Segment Size	<p>Enhances network performance and stability by adjusting the Maximum Segment Size (MSS) of TCP packets to align with the network connection's Path Maximum Transmission Unit (PMTU). It is enabled by default.</p>
DNS Settings	<p>Can be set to obtain the DNS address from the server or to configure it manually.</p>
Primary DNS Server	<p>Primary IPv4 address of the DNS server.</p>
Primary IPv6 DNS Server	<p>Primary IPv6 address of the DNS server.</p>
Secondary DNS Server	<p>Secondary IPv4 address of the DNS server.</p>
Secondary IPv6 DNS Server	<p>Secondary IPv6 address of the DNS server.</p>

Table 30: PPPoE Configuration



Setting an incorrect packet size value (MRU, MTU) can cause unsuccessful transmission.

3.8 WiFi Access Point

- This feature is available only on routers equipped with a WiFi module.
- The router supports the configuration of two separate WLANs (**Multiple SSIDs**).
- **Multi-role mode** allows the router to function as both an access point (AP) and a station (STA) simultaneously. However, multichannel mode is not supported, meaning the AP and STA must operate on the same channel. Please note that only one AP can be active alongside the STA in operation.
- **RADIUS** (Remote Authentication Dial-In User Service), a networking protocol for centralized Authentication, Authorization, and Accounting (AAA) management, is supported for WiFi. The router acts as a RADIUS client (not a server), typically as a WiFi AP (Access Point) communicating with a RADIUS server.



To enable WiFi access point mode, check the *Enable WiFi AP* box at the top of the *Configuration* → *WiFi* → *Access Point 1* or *Access Point 2* configuration pages. In this mode, the router functions as an access point, allowing other devices in *station (STA)* mode to connect.

The table below lists the available configuration options.

Item	Description
Enable WiFi AP	Enables the WiFi access point (AP).
IP Address	A fixed IP address for the WiFi interface. Use IPv4 notation in the IPv4 column and IPv6 notation in the IPv6 column. Shortened IPv6 notation is supported.
Subnet Mask / Prefix	Specifies a Subnet Mask for the IPv4 address. In the IPv6 column, enter the prefix length (0 to 128).
Bridged	Activates bridge mode: <ul style="list-style-type: none"> • no – Bridged mode is disabled (default). The WLAN network is separate from the LAN. • yes – Bridged mode is enabled. The WLAN network is connected to one or more LAN networks. In this case, most of the setting in this table are ignored, and the router uses the settings of the selected network interface (LAN). See the Bridge Notes in Chapter 3.1 for further details.
Enable dynamic DHCP leases	Enables dynamic allocation of IP addresses using the DHCP (DHCPv6) server.
IP Pool Start	Beginning of the range of IP address range assigned to DHCP clients. Use proper notation for IPv4 and IPv6 column.
IP Pool End	End of the range of IP address range assigned to DHCP clients. Use proper notation for IPv4 and IPv6 column.
Lease Time	Duration (in seconds) for which a client can use the assigned IP address.
Enable IPv6 prefix delegation	Enables prefix delegation for IPv6.
Subnet ID	The decimal value of the Subnet ID for the Ethernet inter face. The maximum value depends on the Subnet ID Width.

Continued on next page

Continued from previous page

Item	Description
Subnet ID Width	Maximum Subnet ID Width, which depends on your site's configuration. The remaining bits to reach 64 are used for the prefix.
SSID	The unique identifier (SSID) of the WiFi network.
Broadcast SSID	Defines how the SSID is broadcast in the beacon frame. <ul style="list-style-type: none"> • Enabled – SSID is included in the beacon frame • Zero length – The beacon frame does not include the SSID. Requests for sending beacon frame are ignored. • Clear – SSID characters in beacon frames are replaced with zeros, maintaining the original length. Requests for beacon frames are ignored.
SSID Isolation	When enabled, and a zone is selected, WiFi clients connected to this access point cannot communicate with clients connected to another access point that has a different zone selected. However, clients can still communicate with other clients connected to the same access point unless <i>Client Isolation</i> is also enabled.
Client Isolation	If enabled, the access point isolates each connected client, preventing them from communicating with each other (they are in separate networks and cannot PING each other). If disabled, the access point functions like a switch, allowing clients on the same LAN to see and communicate with each other.
WMM	Enables basic QoS (Quality of Service) for WiFi networks. This feature does not guarantee network throughput but is suitable for simple applications that require QoS.
Country Code	<ul style="list-style-type: none"> • The country code where the router is installed. This code must be entered in ISO 3166-1 alpha-2 format. • For proper and optimal utilization of WiFi functionality in the given region, always set the correct country code. • After changing the country code, save the settings by clicking the <i>Apply</i> button, then continue with further WiFi configuration. • If the country code is not specified, the default "00" code is used. • If an incorrect country code is entered, the router may violate country-specific regulations regarding the use of WiFi parameters. • This option is not available for NAM routers, where the "US" country code is set by default.
Follow STA radio settings	When enabled, and the STA is connected to a foreign AP, the access point's radio settings will automatically adjust to match those of the connected foreign AP.
HW Mode ¹	Specifies the WiFi standard (HW mode) that will be supported by the WiFi access point. <ul style="list-style-type: none"> • IEEE 802.11b (2.4 GHz) • IEEE 802.11b+g (2.4 GHz) • IEEE 802.11b+g+n (2.4 GHz) • IEEE 802.11a (5 GHz) • IEEE 802.11a+n (5 GHz) • IEEE 802.11ac (5 GHz)

Continued on next page

Continued from previous page

Item	Description
Channel ¹	<p>The channel on which the WiFi access point (AP) is transmitting. The available channels depend on the selected <i>Country Code</i>. You can choose <i>Auto</i> to allow the system to select the optimal channel automatically. To view the channels available for a different country code, change the country code, click <i>Apply</i>, and the channel list will update accordingly.</p> <p><u>Note:</u> On NAM routers, only channels 1 to 11 are supported.</p>
Bandwidth ¹	<p>Allows you to select the transfer bandwidth. Note that this option may be unavailable for some hardware modes. If a selected bandwidth is already occupied, the router may automatically switch to a lower bandwidth.</p>
Short GI	<p>This option, available for HW mode 802.11n, enables the use of a short guard interval (GI) of 400 ns instead of the standard 800 ns, improving data transmission efficiency.</p>
Authentication	<p>Defines access control and authorization methods for users in the WiFi network.</p> <ul style="list-style-type: none"> • Open – No authentication required (free access point). • Shared – Basic authentication using a WEP key. • WPA-PSK – Pre-Shared Key (PSK) authentication with WPA encryption. • WPA2-PSK – Pre-Shared Key (PSK) authentication using WPA2 encryption with AES. • WPA3-PSK – Pre-Shared Key (PSK) authentication using WPA3 encryption with AES. • WPA-Enterprise – RADIUS-based authentication using an external server with username/password. • WPA2-Enterprise – RADIUS-based authentication with stronger encryption. • WPA3-Enterprise – RADIUS-based authentication with stronger encryption.
Encryption	<p>Specifies the type of data encryption used in the WiFi network.</p> <ul style="list-style-type: none"> • None – No data encryption. • WEP – Wired Equivalent Privacy (WEP) encryption with static keys. This method is considered insecure and may not be available on some models. • TKIP – Temporal Key Integrity Protocol (TKIP), used for <i>WPA-PSK</i> and <i>WPA2-PSK</i> authentication. • AES – Advanced Encryption Standard (AES), used for <i>WPA2-PSK</i> authentication.
WEP Key Type	<p>Specifies the WEP key format.</p> <ul style="list-style-type: none"> • ASCII – WEP key in ASCII format. • HEX – WEP key in hexadecimal format.
WEP Default Key	<p>Specifies the default WEP key.</p>

Continued on next page

Continued from previous page

Item	Description
WEP Key 1–4	<p>Allows entry of up to four different WEP keys.</p> <ul style="list-style-type: none"> • ASCII format: The WEP key must be entered in quotes and can have the following lengths: <ul style="list-style-type: none"> – 5 characters (40-bit WEP key) – 13 characters (104-bit WEP key) – 16 characters (128-bit WEP key) • Hexadecimal format: The WEP key must be entered using hexadecimal digits and can have the following lengths: <ul style="list-style-type: none"> – 10 hex digits (40-bit WEP key) – 26 hex digits (104-bit WEP key) – 32 hex digits (128-bit WEP key)
WPA PSK Type	<p>Specifies the available key options for WPA-PSK authentication.</p> <ul style="list-style-type: none"> • 256-bit secret – A 64-character hexadecimal key. • ASCII passphrase – An alphanumeric passphrase of 8 to 63 characters. • PSK File – Absolute path to a file containing a list of key-MAC address pairs.
WPA PSK	<p>The key used for WPA-PSK authentication. This key must match the selected WPA PSK type:</p> <ul style="list-style-type: none"> • 256-bit secret – A 64-character hexadecimal string. • ASCII passphrase – An 8 to 63-character passphrase. • PSK File – The absolute path to a file containing PSK key and MAC address pairs.
RADIUS Auth Server IP	<p>IPv4 or IPv6 address of the RADIUS authentication server. This is required when using RADIUS-based authentication.</p>
RADIUS Auth Password	<p>Access password for the RADIUS authentication server. Required when using RADIUS authentication.</p>
RADIUS Auth Port	<p>Port number of the RADIUS authentication server. The default value is 1812. Required when using RADIUS authentication.</p>
RADIUS Acct Server IP	<p>IPv4 or IPv6 address of the RADIUS accounting server. Define this only if it differs from the authentication server. Required when using RADIUS authentication.</p>
RADIUS Acct Password	<p>Access password for the RADIUS accounting server. Define this only if it differs from the authentication server. Required when using RADIUS authentication.</p>
RADIUS Acct Port	<p>Port number of the RADIUS accounting server. The default value is 1813. Define this only if it differs from the authentication server. Required when using RADIUS authentication.</p>
Access List	<p>Defines the mode of the Access/Deny list.</p> <ul style="list-style-type: none"> • Disabled – The Access/Deny list is not used. • Accept – Only clients in the Accept/Deny list can access the network. • Deny – Clients in the Accept/Deny list cannot access the network.

Continued on next page

Continued from previous page

Item	Description
Accept/Deny List	List of client MAC addresses for network access control. Each MAC address should be entered on a new line.
Syslog Level	Defines the logging level used when writing to the system log. <ul style="list-style-type: none"> • Verbose debugging – The highest level of logging. • Debugging • Informational – The default logging level. • Notification • Warning – The lowest level of system logging.
Extra options	Allows the user to define additional parameters for <code>hostapd</code> . Options are added as-is to the end of the configuration file. For more information, refer to the <code>hostapd.conf</code> Linux man page. Use this option only if you are familiar with its functionality.

Table 31: WiFi Configuration Items Description

¹The availability of configuration options may vary depending on the specific WiFi module and can be affected by the selected country code.

WiFi AP 1 Configuration	
<input type="checkbox"/> Enable WiFi AP 1	
IP Address	IPv4 <input type="text"/> IPv6 <input type="text"/>
Subnet Mask / Prefix	<input type="text"/> <input type="text"/>
Bridged	<input type="text" value="no"/> ▼
<input type="checkbox"/> Enable dynamic DHCP leases	
IP Pool Start	IPv4 <input type="text"/> IPv6 <input type="text"/>
IP Pool End	<input type="text"/> <input type="text"/>
Lease Time	600 <input type="text"/> 600 <input type="text"/> sec
<input type="checkbox"/> Enable IPv6 prefix delegation	
Subnet ID *	<input type="text"/>
Subnet ID Width *	<input type="text"/> bits
SSID	<input type="text"/>
Broadcast SSID	<input type="text" value="enabled"/> ▼
SSID Isolation	<input type="text" value="disabled"/> ▼
Client Isolation	<input type="text" value="disabled"/> ▼
WMM	<input type="text" value="disabled"/> ▼
<i>The following radio settings are common for all Access Points on WiFi module 1</i>	
Country Code *	<input type="text"/>
HW Mode	<input type="text" value="IEEE 802.11b"/> ▼
Channel	<input type="text" value="1"/> ▼
Bandwidth	<input type="text" value="20 MHz"/> ▼
Short GI	<input type="text" value="disabled"/> ▼
Authentication	<input type="text" value="open"/> ▼
Encryption	<input type="text" value="none"/> ▼
WEP Key Type	<input type="text" value="ASCII"/> ▼
WEP Default Key	<input type="text" value="1"/> ▼
WEP Key 1	<input type="text"/>
WEP Key 2	<input type="text"/>
WEP Key 3	<input type="text"/>
WEP Key 4	<input type="text"/>
WPA PSK Type	<input type="text" value="256-bit secret"/> ▼
WPA PSK	<input type="text"/>
RADIUS Auth Server IP	<input type="text"/>
RADIUS Auth Password	<input type="text"/>
RADIUS Auth Port *	<input type="text" value="1812"/>
RADIUS Acct Server IP *	<input type="text"/>
RADIUS Acct Password *	<input type="text"/>
RADIUS Acct Port *	<input type="text" value="1813"/>
Access List	<input type="text" value="disabled"/> ▼
Accept/Deny List	<input type="text"/>
Syslog Level	<input type="text" value="informational"/> ▼
Extra options *	<input type="text"/>
* can be blank	
<input type="button" value="Apply"/>	

Figure 32: WiFi Access Point Configuration Page

3.9 WiFi Station



- This feature is available only on routers equipped with a WiFi module.
- The WiFi module supports **multi-role mode**, allowing the router to operate as both an access point (AP) and a station (STA) simultaneously. However, **multichannel mode is not supported**, meaning the AP and STA must operate on the same channel.
- In WiFi STA mode, only the authentication methods **EAP-PEAP/MSCHAPv2** (both PEAPv0 and PEAPv1) and **EAP-TLS** are supported.

Activate WiFi station mode by checking the *Enable WiFi STA* box at the top of the *Configuration → WiFi → Station* configuration page. In this mode, the router functions as a client station, receiving data packets from the available access point (AP) and transmitting data from its wired connection over the WiFi network.

WiFi STA Configuration	
<input type="checkbox"/> Enable WiFi STA	
DHCP Client	IPv4: enabled IPv6: enabled
IP Address	
Subnet Mask / Prefix	
Default Gateway	
Primary DNS Server	
Secondary DNS Server	
SSID	
Probe Hidden SSID	disabled
Country Code *	
Authentication	open
Encryption	none
WEP Key Type	ASCII
WEP Default Key	1
WEP Key 1	
WEP Key 2	
WEP Key 3	
WEP Key 4	
WPA PSK Type	256-bit secret
WPA PSK	
RADIUS EAP Authentication	EAP-PEAP/MSCHAPv2
RADIUS CA Certificate	<input type="text"/> Choose File No file chosen
RADIUS Local Certificate	<input type="text"/> Choose File No file chosen
RADIUS Local Private Key	<input type="text"/> Choose File No file chosen
RADIUS Identity	<input type="text"/>
RADIUS Password	<input type="text"/>
Syslog Level	informational
Extra options *	<input type="text"/>
* can be blank	
<input type="button" value="Apply"/>	

Figure 33: WiFi Station Configuration Page

Item	Description
Enable WiFi STA	Enables the WiFi station (STA) mode.
DHCP Client	Activates or deactivates the DHCP client. In the IPv6 column, this enables the DHCPv6 client.
IP Address	Specifies a fixed IP address for the WiFi interface. Use IPv4 notation in the IPv4 column and IPv6 notation in the IPv6 column. Shortened IPv6 notation is supported.
Subnet Mask / Prefix	Defines a subnet mask for the IPv4 address. In the IPv6 column, enter the prefix length (a number between 0 and 128).
Default Gateway	Specifies the IP address of the default gateway. If provided, all packets with destinations not found in the routing table are sent to this gateway. Use the appropriate IP address notation in the IPv4 and IPv6 columns.
Primary DNS Server	Specifies the primary IP address of the DNS server. If the requested IP address is not found in the routing table, this DNS server is queried. Use proper IP address notation in the IPv4 and IPv6 columns.
Secondary DNS Server	Specifies the secondary IP address of the DNS server.
SSID	The unique identifier of the WiFi network.
Probe Hidden SSID	An access point (AP) with a hidden SSID (see the Broadcast SSID option in the AP configuration) does not respond to broadcast probe requests, preventing the station from obtaining the necessary information to connect. Enable this option to force the station to probe a specific SSID. If you do not expect a hidden SSID, it is recommended to disable this setting to avoid unnecessary radio transmissions.
Country Code	<ul style="list-style-type: none"> • Note: The country code must be entered in ISO 3166-1 alpha-2 format. • Optional entry of the country code where the router is installed. • If not specified, the code is inherited from the AP to which the STA connects. • If an incorrect country code is entered, the router may violate country-specific regulations regarding WiFi parameters. • This option is not available for NAM routers, where the "US" country code is set by default.

Continued on the next page

Continued from previous page

Item	Description
Authentication	<p>Access control and authorization of users in the WiFi network.</p> <ul style="list-style-type: none"> • Open – No authentication required (public access point). • Shared – Authentication based on Pre-Shared Keys (PSK) using the WEP protocol (considered insecure). • WPA-PSK – Authentication based on Pre-Shared Keys (PSK) using the original WPA protocol (considered insecure). • WPA2-PSK – Authentication based on Pre-Shared Keys (PSK) using the WPA2 standard. • WPA3-PSK – Authentication based on Pre-Shared Keys (PSK) using the latest WPA3 standard. • WPA-Enterprise – Authentication using RADIUS with the original WPA protocol (considered insecure). • WPA2-Enterprise – Authentication using RADIUS with the WPA2 standard. • WPA3-Enterprise – Authentication using RADIUS with the WPA3 standard.
Encryption	<p>Type of data encryption in the WiFi network:</p> <ul style="list-style-type: none"> • None – No encryption (unencrypted network). • WEP – Static encryption using WEP keys. This encryption can be used with Shared authentication but is considered insecure and may not be supported on some models. • TKIP – Legacy dynamic encryption used with WPA and WPA2 authentication. • AES – Modern dynamic encryption used with WPA2 and WPA3 authentication.
WEP Key Type	<p>Specifies the format of the WEP key:</p> <ul style="list-style-type: none"> • ASCII – WEP key in ASCII format. • HEX – WEP key in hexadecimal format.
WEP Default Key	<p>Defines the default WEP key used for encryption.</p>
WEP Key 1–4	<p>Allows entry of up to four different WEP keys:</p> <ul style="list-style-type: none"> • WEP key in ASCII format (must be enclosed in quotes). Supported lengths: <ul style="list-style-type: none"> – 5 ASCII characters (40-bit WEP key) – 13 ASCII characters (104-bit WEP key) – 16 ASCII characters (128-bit WEP key) • WEP key in hexadecimal format. Supported lengths: <ul style="list-style-type: none"> – 10 hexadecimal digits (40-bit WEP key) – 26 hexadecimal digits (104-bit WEP key) – 32 hexadecimal digits (128-bit WEP key)

Continued on the next page

Continued from previous page

Item	Description
WPA PSK Type	Specifies the type of key used for WPA-PSK authentication. <ul style="list-style-type: none"> • 256-bit secret – Requires a 64-digit hexadecimal key. • ASCII passphrase – Accepts a passphrase between 8 and 63 characters.
WPA PSK	The WPA-PSK authentication key. The key format depends on the selected WPA PSK type: <ul style="list-style-type: none"> • 256-bit secret – Must be a 64-digit hexadecimal value. • ASCII passphrase – Must contain between 8 and 63 characters.
RADIUS EAP Authentication	Specifies the EAP protocol used for authentication. <ul style="list-style-type: none"> • EAP-PEAP/MSCHAPv2 – Uses TLS to protect legacy EAP authentication. • EAP-TLS – Utilizes TLS for mutual authentication between the client and server.
RADIUS CA Certificate	The Certificate Authority (CA) certificate used to verify the server certificate when EAP-TLS authentication is selected.
RADIUS Local Certificate	The client certificate required for authentication when EAP-TLS is selected.
RADIUS Local Private Key	The private key associated with the client certificate for EAP-TLS authentication.
RADIUS Identity	The identity used for connecting to the RADIUS server.
RADIUS Password	The password used to authenticate the RADIUS identity when EAP-PEAP/MSCHAPv2 authentication is selected.
RADIUS Local Private Key Password	Password used to access the RADIUS Local Private Key when EAP-TLS authentication is selected.
Syslog Level	Defines the logging level for system log messages. <ul style="list-style-type: none"> • Verbose debugging – The highest level of logging. • Debugging • Informational – Default logging level. • Notification • Warning – The lowest level of system communication.
Extra options	Allows users to define additional parameters for <code>hostapd</code> . The options are appended directly to the configuration file. For more details, refer to the <code>hostapd.conf</code> Linux man page. Use this feature only if you fully understand its implications.

Table 32: WLAN Configuration Items Description

3.10 Backup Routes



- Note that some interfaces, typically WiFi, ETH2, or ETH1, may not be available for some router product lines or for the model you are currently using.
- Note that an ETH interface won't be used as WAN for the default backup route priorities if neither an IP address is configured nor the DHCP client is enabled for this ETH interface.
- Just for the default priorities mode: Unplugging the Ethernet cable does not switch the WAN interface to the next one in order.

Typically, you want the router to direct traffic from the whole LAN (Local Area Network) behind the router to an external WAN (Wide Area Network) outside, such as the Internet.

Backup Routes is a mechanism that enables customizing which router's interfaces will be used for communication to the WAN outside the router. The *Backup Routes* configuration page is shown in Figure 34.

You may not care about this configuration and leave this process on the default router mechanism. In this case, leave the *Backup Routes* configuration page as it is, unconfigured, and the router will proceed as described in Chapter 3.10.1 *Default Priorities for Backup Routes*.

If you want to set up this feature your way, see Chapter 3.10.2 *User Customized Backup Routes* for more information.

3.10.1 Default Priorities for Backup Routes

By default, when the first checkbox, *Enable backup routes switching*, is unchecked, the backup routes system is not user customized and operates with the default mechanism. Instead, the router selects a route to the WAN based on the default priorities.

The following is the list of the network interfaces in descending order from the highest priority to the lowest priority interface for use as a WAN interface.

1. **Mobile WAN** (pppX, usbX)
2. **PPPoE** (ppp0)
3. **WiFi STA** (wlan0)
4. **ETH1** (eth1)
5. **ETH2** (eth2)
6. **ETH0** (eth0)

For example, based on the list above, we can say that the ETH1 interface will only be used as the WAN interface if Mobile WAN, PPPoE, and WiFi STA interfaces are down or disabled.

It is clear from the above that an interface connected to a LAN network can take over the role of a WAN interface under certain circumstances. Possible communication from the LAN to the WAN can be blocked or forwarded rules configured on the *NAT* and *Firewall* configuration pages.

3.10.2 User Customized Backup Routes

You can choose preferred router interfaces acting as the WAN, including their priorities, on the *Backup Routes* configuration page; see Figure 34. Switching between the WAN is then carried out according to the order of priority and the state of all the affected interfaces.

There are three different modes you can choose for the connection backup as described in Table 33.

Item	Description
Enable backup routes switching	Enables the customized backup routes setting made on the whole configuration page . If disabled (unchecked), the backup routes system operates in the default mechanism, as described in Chapter 3.10.1.
Mode	<p>Single WAN</p> <ul style="list-style-type: none"> • Just one interface is used for the WAN communication at a time. • Other interfaces (if enabled) are used as the backup routes for the WAN communication when the active interface fails (based on the priorities set). • Just one interface, currently active, is allowed to access the router from a network outside the router. <p>Multiple WANs</p> <ul style="list-style-type: none"> • Just one interface is used for the WAN communication at a time. • Other interfaces (if enabled) are used as the backup routes for the WAN communication when the active interface fails (based on the priorities set). • The router is accessible from networks outside on all enabled interfaces. This is the only difference from the <i>Single WAN</i> mode. <p>Load Balancing</p> <ul style="list-style-type: none"> • In this mode, it is possible to split the volume of data passing through individual WAN interfaces. • If the mode was chosen, the weight for every interface is enabled in the GUI and can be set. • This setting determines the relative number of data streams passing through the interfaces.

Table 33: Backup Routes Modes Items Description

You have now selected a backup route mode. To add a network interface to the backup routes system, mark the enable checkbox of that interface. Enabled interfaces are used for WAN access based on their priorities.



Note for Load Balancing mode: The weight setting for load balancing may not precisely match the amount of balanced data. It depends on the number of data flows and the data structure. The best result of the balancing is achieved for a high amount of data flows.



Note for Mobile WAN: If you want to use a mobile WAN connection as a backup route, choose the *enable + bind* option in the *Check Connection* item on the *Mobile WAN* page and fill in the ping address; see chapter 3.5.1.



Note for an ETH interface: Unlike the default backup route mode, disconnecting the Ethernet cable from an ETH interface switches the route to the next in the sequence.

Settings, which can be made for each interface, are described in the table below. Any changes made to settings will be applied after pressing the *Apply* button.

Item	Description
Priority	Priority for the type of connection (network interface).
Ping IP Address	Destination IPv4 address or domain name of ping queries to check the connection.
Ping IPv6 Address	Destination IPv6 address or domain name of ping queries to check the connection.
Ping Interval	The time interval between consecutive ping queries.
Ping Timeout	Time in seconds to wait for a response to the ping.
Weight	Weight for the Load Balancing mode only. The number from 1 to 256 determines the ratio for load balancing of the interface. For example, if two interfaces set the weight to 1, the ratio is 50% to 50%. If they set the weight up to 1 and 4, the ratio is 20% to 80%.

Table 34: Backup Routes Configuration Items Description

Other notes:

- The system checks the status state of an interface. For example, unlike the *Default Priorities* mode, unplugging the Ethernet cable triggers a switchover to the next WAN interface in the sequence.
- To monitor the interface availability, you can use one or both Ping IP Addresses (IPv4 and IPv6) based on the IP protocol used on a particular network interface and WAN connection settings.

Backup Routes Configuration	
<input type="checkbox"/> Enable backup routes switching	
Mode	Single WAN
<input type="checkbox"/> Enable backup routes switching for Mobile WAN	
Priority	1st
Weight	
<input type="checkbox"/> Enable backup routes switching for PPPoE	
Priority	1st
Ping IP Address	
Ping IPv6 Address	
Ping Interval	sec
Ping Timeout	10 sec
Weight	
<input type="checkbox"/> Enable backup routes switching for WiFi STA	
Priority	1st
Ping IP Address	
Ping IPv6 Address	
Ping Interval	sec
Ping Timeout	10 sec
Weight	
<input type="checkbox"/> Enable backup routes switching for ETH0	
Priority	1st
Ping IP Address	
Ping IPv6 Address	
Ping Interval	sec
Ping Timeout	10 sec
Weight	
<input type="checkbox"/> Enable backup routes switching for ETH1	
Priority	1st
Ping IP Address	
Ping IPv6 Address	
Ping Interval	sec
Ping Timeout	10 sec
Weight	
<input type="button" value="Apply"/>	

Figure 34: Backup Routes Configuration Page

3.10.3 Backup Routes Examples

Example #1: Default Settings

As already described above, by default, if the *Backup Routes* are unconfigured, the system operates with the default priorities as described in Chapter 3.10.1. Figure 35 shows the GUI configuration.

Note: Assume all the affected interfaces are correctly configured and activated on their configuration pages.



Figure 35: Example #1: GUI Configuration

Figure 36 illustrates the example topology.

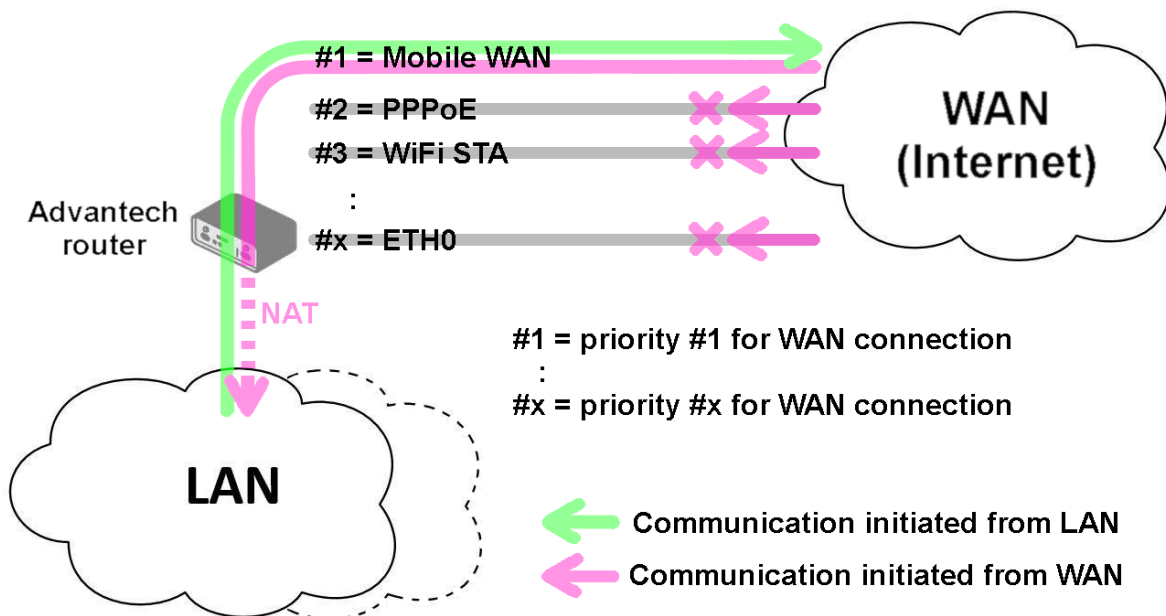

Figure 36: Example #1: Topology

Example #2: Default Routes Switching

This example illustrates when the interface, primarily used for the WAN connection, is down. Its role is taken over by the interface with the second highest priority. Since the *Backup Routes* configuration is still unconfigured, the system operates with the default system priorities described in Chapter 3.10.1. Figure 37 shows the GUI configuration.

Note: Assume all the affected interfaces are correctly configured and activated on their configuration pages.



Figure 37: Example #2: GUI Configuration

Figure 38 illustrates the example topology.

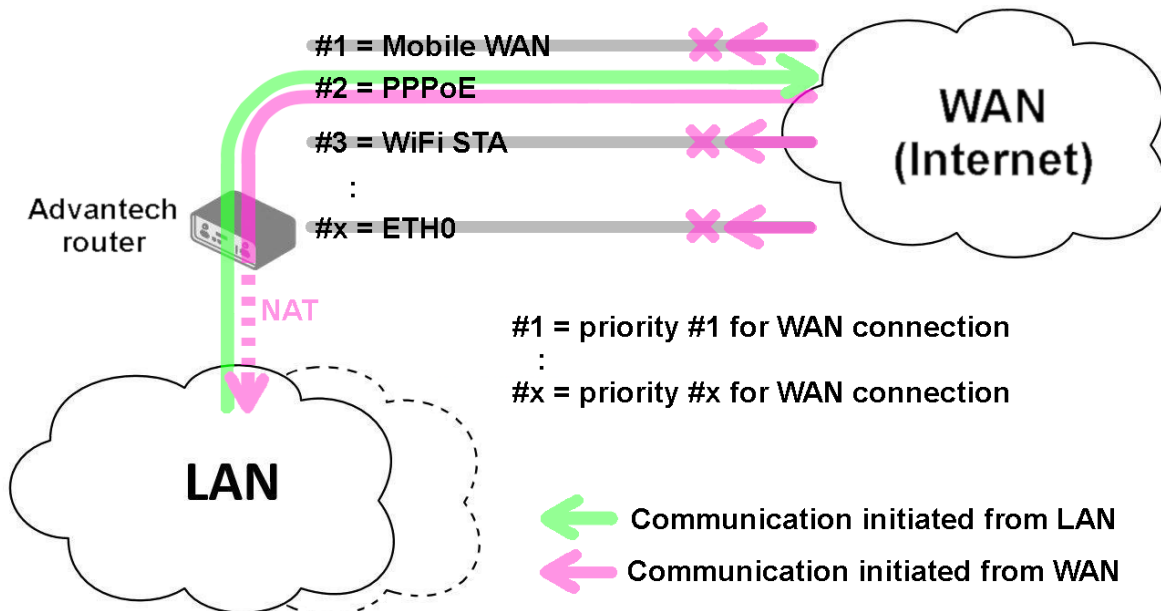

Figure 38: Example #2: Topology

Example #3: Custom Backup Routes

This example illustrates the configuration of custom backup routes for the Mobile WAN, PPPoE, and ETH1 interfaces. The Mobile WAN interface has the highest priority, and the ETH1 interface has the lowest priority. Figure 39 shows the GUI configuration.

Note: Assume all the affected interfaces are correctly configured and activated on their configuration pages.

Backup Routes Configuration

Enable backup routes switching
Mode Single WAN

Enable backup routes switching for Mobile WAN
Priority 1st
Weight

Enable backup routes switching for PPPoE
Priority 2nd
Ping IP Address 172.16.1.1
Ping IPv6 Address
Ping Interval 30 sec
Ping Timeout 10 sec
Weight

Enable backup routes switching for WiFi STA

Enable backup routes switching for ETH0

Enable backup routes switching for ETH1
Priority 3rd
Ping IP Address
Ping IPv6 Address
Ping Interval sec
Ping Timeout 10 sec
Weight

Apply

Figure 39: Example #3: GUI Configuration

Figure 40 illustrates the example topology for *Single WAN mode*. If the Mobile WAN connection goes down, the PPPoE tunnel takes its role, and so on. The ping to the 172.16.1.1 address, tested every 30 seconds with a timeout of 10 seconds, checks the status of the PPPoE tunnel.

Figure 41 illustrates the example topology for *Multiple WAN mode*. As you can see, the only difference between these two modes is that in the *Multiple WAN mode*, the router is accessible on all interfaces from the WAN simultaneously.

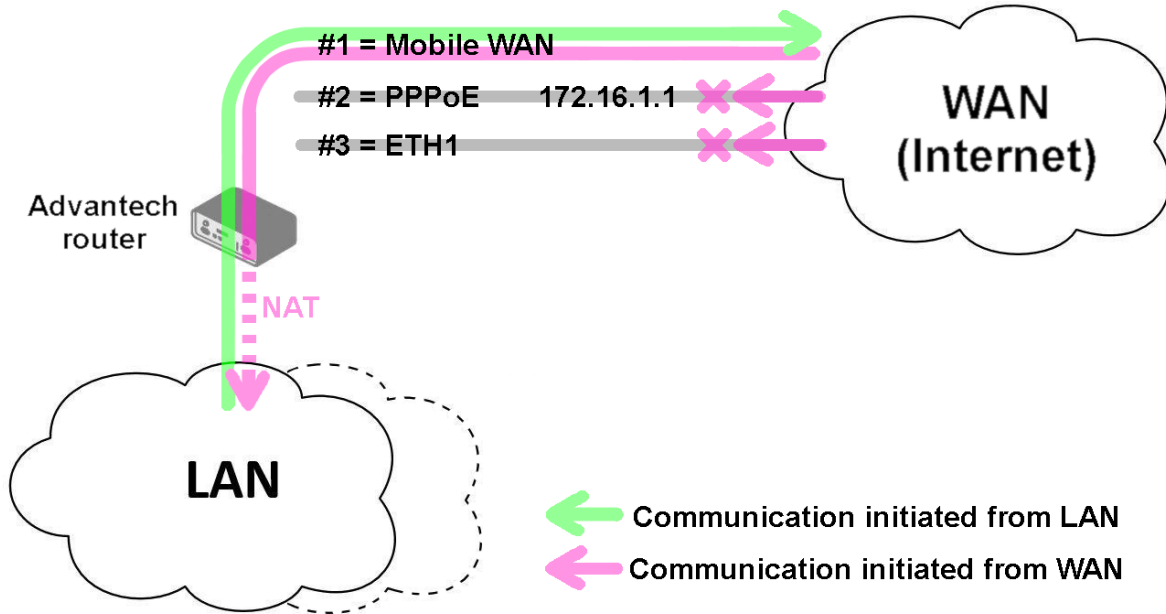

Figure 40: Example #3: Topology for *Single WAN mode*

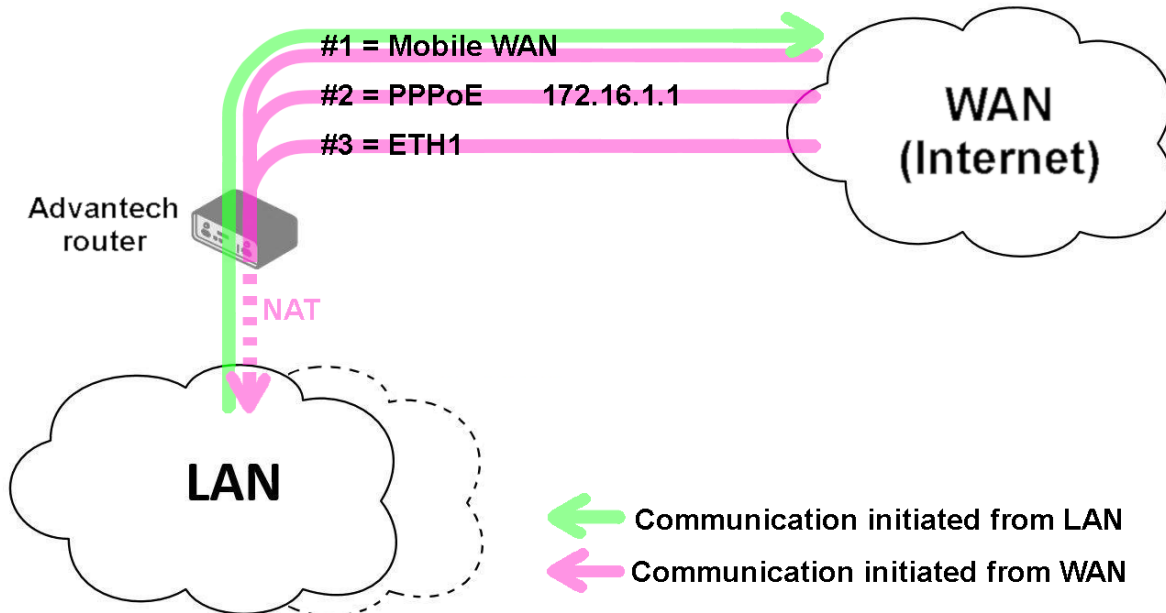

Figure 41: Example #3: Topology for *Multiple WAN mode*

Example #4: Load Balancing Mode #1



If both cellular modules are enabled, the weight set for the MWAN is applied to both cellular modules. For that reason, the total weight for the MWAN is double.

In this example, the only one enabled is the MWAN interface. Because the entry of the weight field is mandatory, it is set to 1, but it has no significance. Because both cellular modules are enabled and running, 50 % of data streams are directed to the first cellular module and 50 % to the second cellular module. Figure 42 shows the GUI configuration.

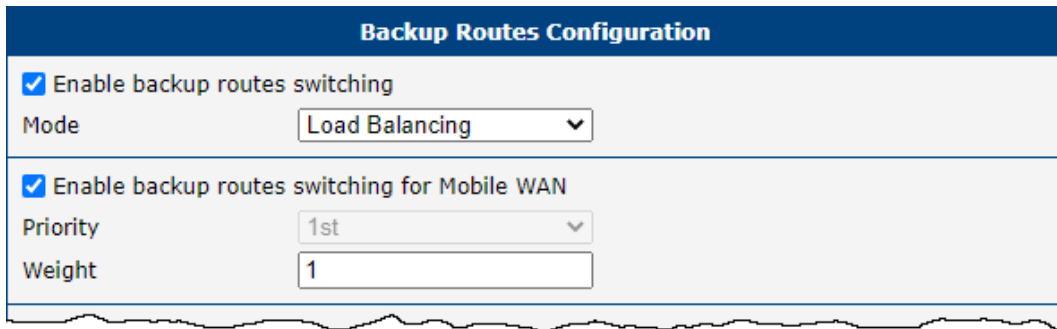

Figure 42: Example #4: GUI Configuration

Figure 43 illustrates the example topology.

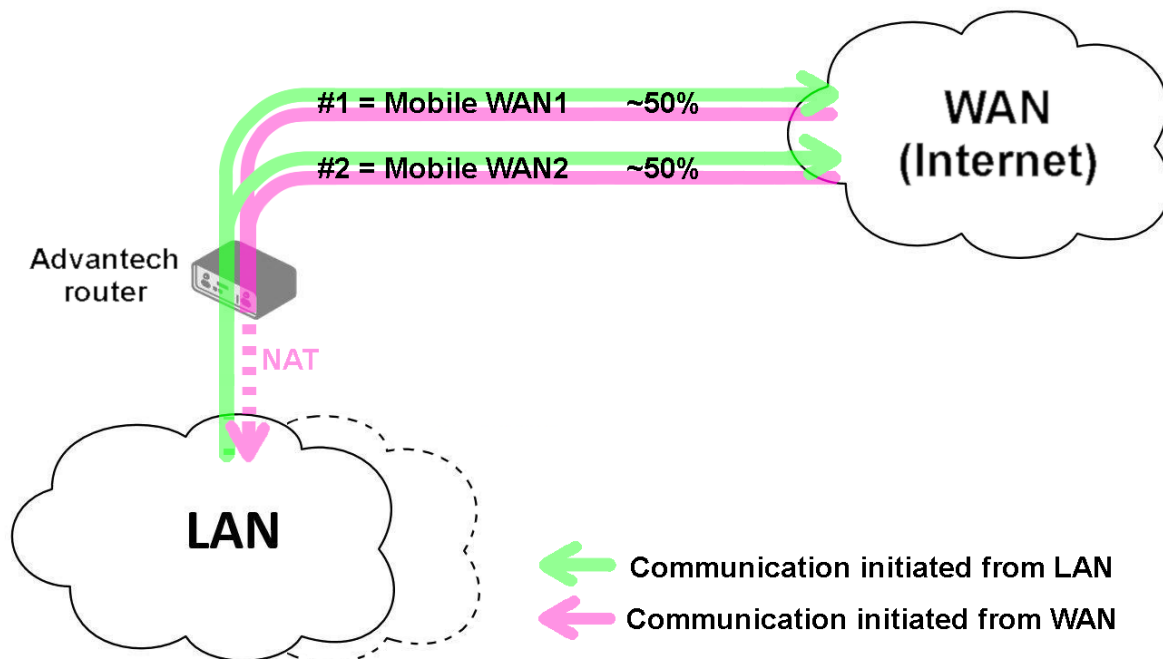

Figure 43: Example #4: Topology

Example #5: Load Balancing Mode #2

In this are enabled the MWAN and PPPoE interfaces. The weight set to the MWAN is 2 (2 to the first and 2 to the second cellular module – total weight is 4) and 1 to the PPPoE. Because both cellular modules are enabled and running, 40 % of data streams are directed to the first cellular module, 40 % to the second cellular module and 20 % to the PPPoE. Figure 44 shows the GUI configuration.

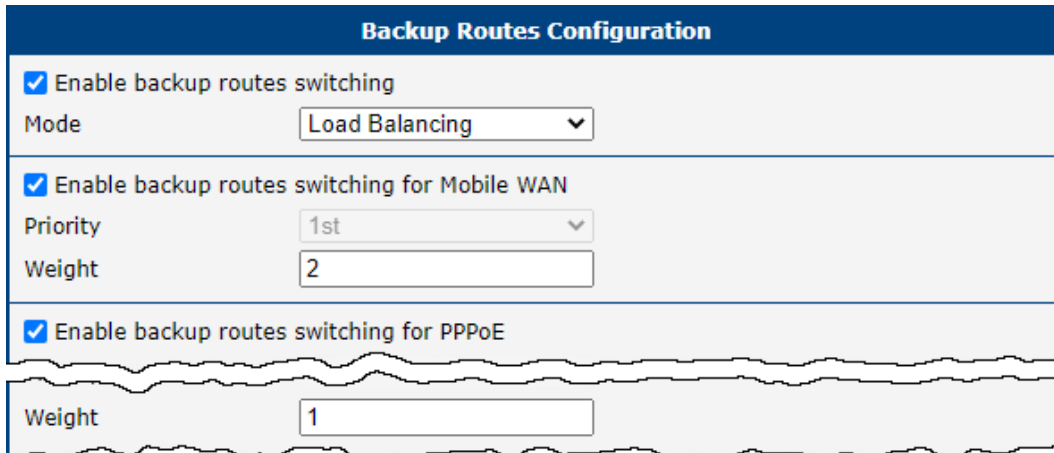

Figure 44: Example #5: GUI Configuration

Figure 45 illustrates the example topology.

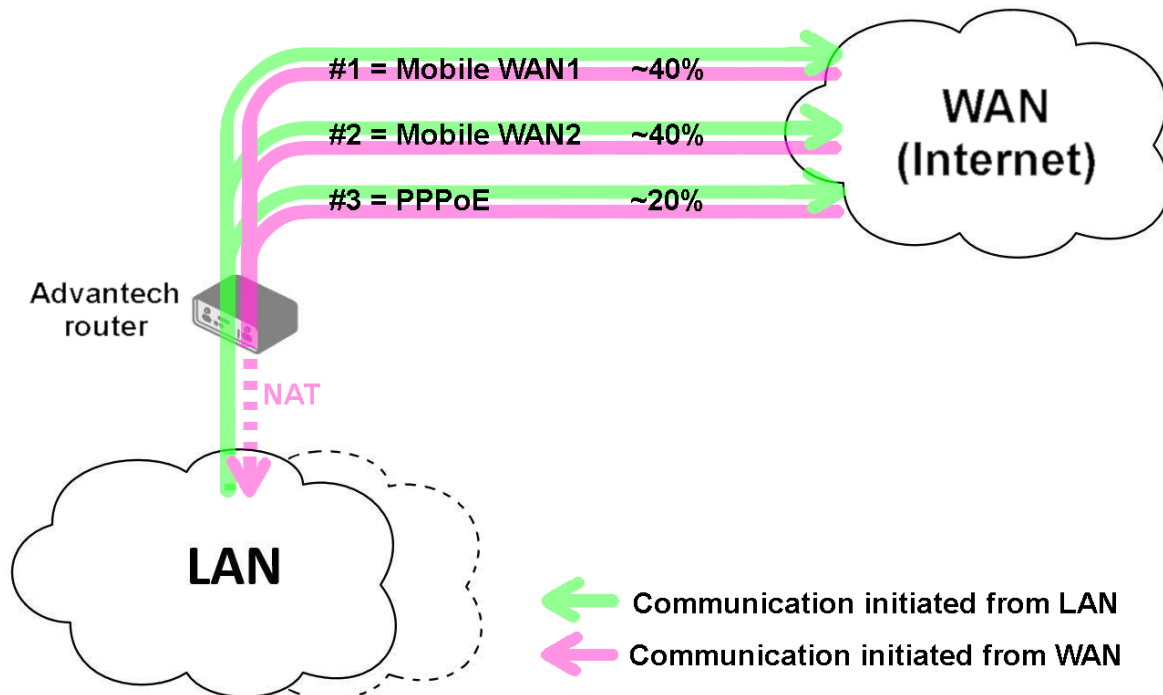

Figure 45: Example #5: Topology

Example #6: Load Balancing Mode #3

In this example are enabled the MWAN, WiFi STA and 2nd LAN interfaces. The weight set to MWAN is 1 (1 to the first and 1 to the second cellular module – total weight is 2), 1 to the WiFi STA and 1 to the 2nd LAN. Because both cellular modules are enabled and running, 25 % of data streams are directed to the first cellular module, 25 % to the second cellular module, 25 % to the WiFi STA and 25 % to the 2nd LAN. Figure 46 shows the GUI configuration. Figure 47 illustrates the example topology.

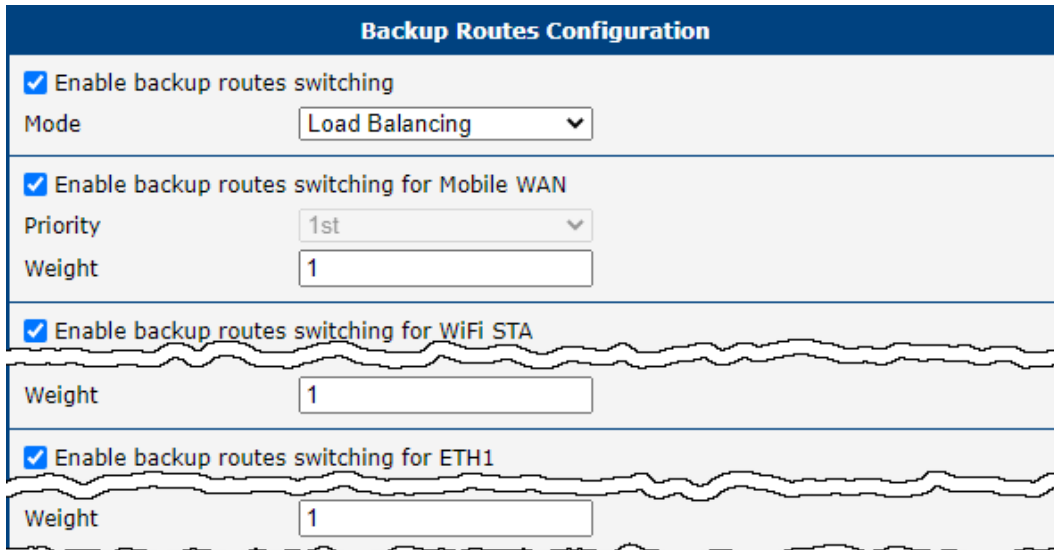

Figure 46: Example #6: GUI Configuration

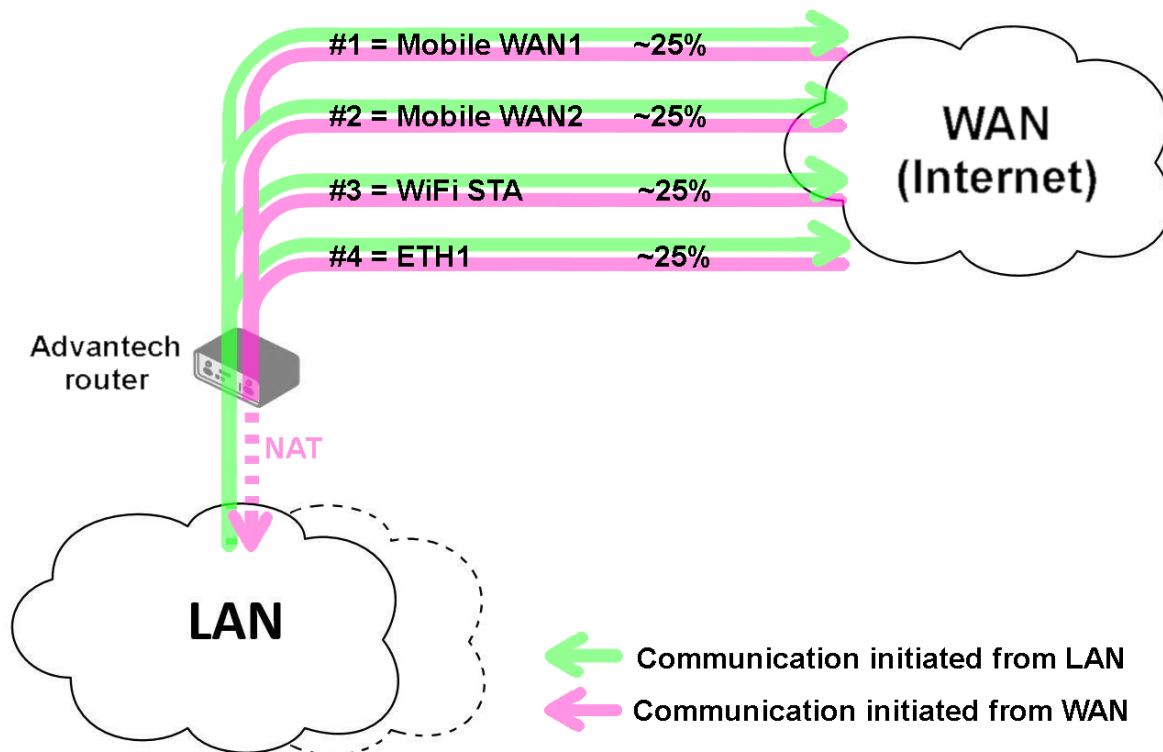

Figure 47: Example #6: Topology

Example #7: No WAN Routes

This example illustrates when *Router Backup* is enabled but no specific interface is selected for the WAN route. In this case, the router has no dedicated WAN interface and routes the traffic within the LANs. Figure 48 shows the GUI configuration.

Note: The Mobile WAN interface is not accessible, even if configured and connected to a cellular network.

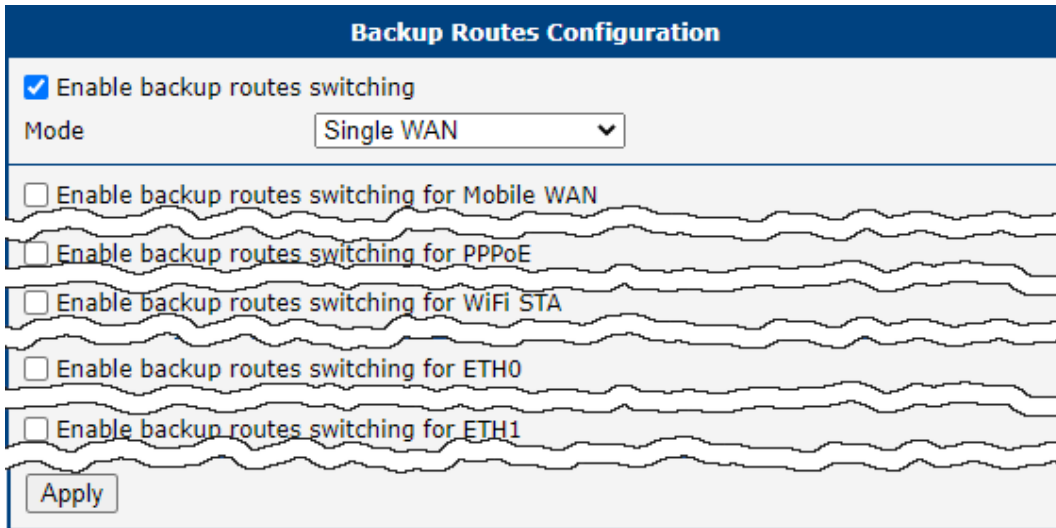

Figure 48: Example #7: GUI Configuration

Figure 49 illustrates the example topology.

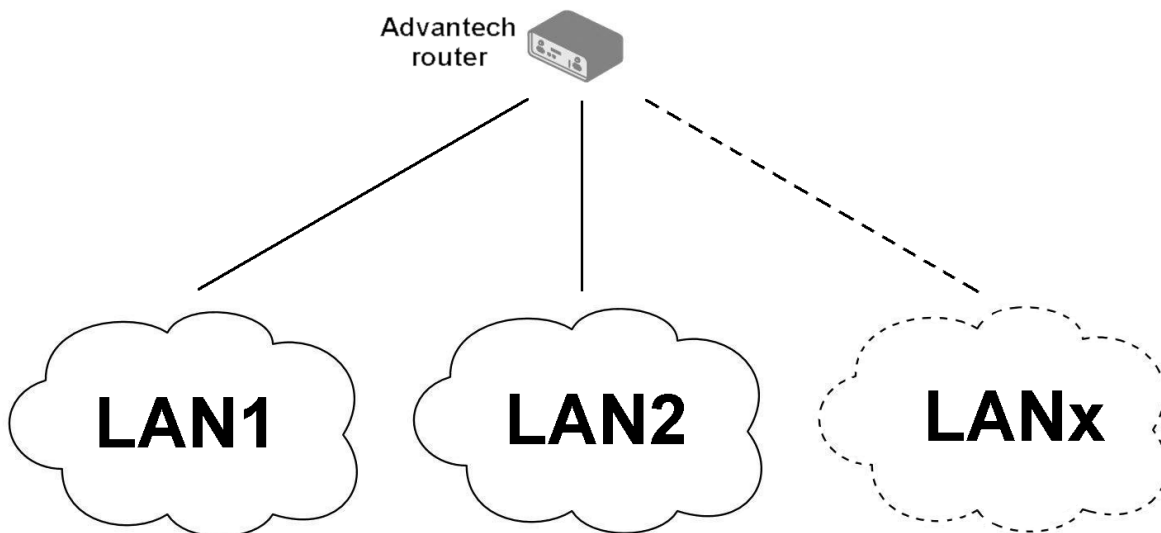

Figure 49: Example #7: Topology

3.11 Static Routes

Static routes can be configured on the *Static Routes* page. A static route provides a fixed routing path within the network. It is manually set on the router and must be updated whenever the network topology changes.

By default, static routes remain private unless redistributed by a routing protocol. Two configuration forms are available: one for IPv4 and another for IPv6. You can define up to thirty-two rules for each, IPv4 and IPv6 form. A new row for defining the next rule appears automatically after filling in the previous one. The static routes configuration form for IPv4 is shown in Figure 50.

Figure 50: Static Routes Configuration Page

The description of all configuration items is listed in Table 35.

Item	Description
Enable IPv4 static routes	Enables static routing functionality when checked. Only routes explicitly enabled via the checkbox in the first column of the table become active.
Destination Network	Specifies the destination IP address of the remote network or host to which the static route applies.
Mask or Prefix Length	Defines the subnet mask or prefix length of the remote network or host IP address.
Gateway	Specifies the IP address of the gateway device that facilitates communication between the router and the remote network or host.
Metric	Defines the route priority within the routing table. Lower metric values indicate higher priority.
Interface ¹	Selects the interface through which the remote network or host is reachable.

Table 35: Static Routes Configuration for IPv4

¹The *Any* interface allows users, for example, to configure static routes toward a GRE tunnel. When using this interface, specifying a *Gateway* address is mandatory, as it determines the interface through which communication occurs.

3.12 Firewall

The firewall is responsible for filtering network traffic. The router implements independent IPv4 and IPv6 firewalls, as it supports a dual-stack configuration for both protocols.

Clicking the *Firewall* item in the *Configuration* menu on the left expands it into three submenus: *IPv4*, *IPv6*, and *Sites*.

Figure 51 displays the default configuration page for the IPv6 firewall. The configuration fields are identical in both the *IPv4 Firewall Configuration* and *IPv6 Firewall Configuration* forms.

IPv6 Firewall Configuration

Enable filtering of incoming packets

		Source *	Protocol	Target Port(s) *	Action	Description *
1	<input type="checkbox"/>	<input type="text"/>	all ▼	<input type="text"/>	allow ▼	<input type="text"/>
2	<input type="checkbox"/>	<input type="text"/>	all ▼	<input type="text"/>	allow ▼	<input type="text"/>

Maximum 32 items

Enable filtering of forwarded packets

		Source *	Destination *	Protocol	Target Port(s) *	Action	Description *
1	<input type="checkbox"/>	<input type="text"/>	64:ff9b::/96	all ▼	<input type="text"/>	allow ▼	Default rule for NAT64
2	<input type="checkbox"/>	<input type="text"/>	<input type="text"/>	all ▼	<input type="text"/>	allow ▼	<input type="text"/>
3	<input type="checkbox"/>	<input type="text"/>	<input type="text"/>	all ▼	<input type="text"/>	allow ▼	<input type="text"/>

Maximum 32 items

Enable filtering of locally destined packets

Enable protection against DoS attacks

* can be blank

Figure 51: IPv6 Default Firewall Configuration

The first section of the configuration form defines the **incoming firewall policy**. If the *Enable filtering of incoming packets* checkbox is unchecked, all incoming connections are accepted. When enabled, and if connections originate from the WAN interface, the router checks them against the PREROUTING chain in the mangle table. The router accepts a connection only if a matching rule exists with the *Action* set to *accept* (the first matching rule is applied). If no matching rule is found or if the *Action* is set to *deny*, the connection is dropped.

You can define rules based on IP addresses, protocols, and ports to allow or deny access to the router and the internal network behind it. The system allows up to thirty-two rules, each of which can be enabled or disabled using the checkbox on the left of the rule row. A new row for defining the next rule appears automatically after filling in the previous one. See Table 36 for a description of the incoming rule definitions.

Please note that incoming rules apply only to connections originating **from the WAN side** (or WAN interface). For details on priority rules related to WAN interfaces, refer to Chapter 3.10.1.

Item	Description
Source ¹	Specifies the IP address to which the rule applies. Use an IPv4 address in <i>IPv4 Firewall Configuration</i> and an IPv6 address in <i>IPv6 Firewall Configuration</i> .
Protocol	Specifies the protocol to which the rule applies: <ul style="list-style-type: none"> • all – The rule applies to all protocols, including those not listed below. • TCP – The rule applies to the TCP protocol. • UDP – The rule applies to the UDP protocol. • GRE – The rule applies to the GRE protocol. • ESP – The rule applies to the ESP protocol. • ICMP/ICMPv6 – The rule applies to the ICMP protocol. In the <i>IPv6 Firewall Configuration</i>, there is an option for ICMPv6.
Target Port(s)	Specifies the port numbers or range that allow access to the router. Enter the initial and final port numbers separated by a hyphen. A single static port can also be specified.
Action	Specifies the action the router performs based on the rule: <ul style="list-style-type: none"> • allow – The router permits the packets to enter the network. • deny – The router blocks the packets from entering the network.
Description	A user-defined description of the rule.

Table 36: Filtering of Incoming Packets

The next section of the configuration form defines the **forwarding firewall policy**. If the *Enable filtering of forwarded packets* checkbox is unchecked, all incoming packets are accepted. When enabled, and if a packet is addressed to another network interface, the router processes it through the FORWARD chain in the iptables firewall. If the FORWARD chain accepts the packet, the router forwards it, provided there is a corresponding entry in the routing table.

You can define up to thirty-two rules, each of which can be enabled or disabled using the checkbox on the left side of the rule row. A new row for defining the next rule appears automatically after filling in the previous one. The forwarding settings apply to all interfaces, regardless of whether the interface is designated as WAN.

The configuration form includes a table for specifying filter rules. You can create a rule to allow data for a selected protocol by specifying only the protocol, or you can define stricter rules by specifying values for source IP addresses, destination IP addresses, and ports. See Table 37 for a description of the forwarding rule definitions.



As shown in the Figure 51, the first entry in the IPv6 forwarded packets configuration is the default firewall rule for NAT64, which is disabled by default. To enable the NAT64 interface, navigate to *Configuration* → *NAT* → *IPv6* → *Enable NAT64*.

¹This field supports IP address input in the formats: `IP` , `IP/mask` , or `IP_start-IP_end` .

Item	Description
Source ¹	Specifies the source IP address to which the rule applies. Use an IPv4 address in the <i>IPv4 Firewall Configuration</i> and an IPv6 address in the <i>IPv6 Firewall Configuration</i> .
Destination ¹	Specifies the destination IP address to which the rule applies. Use an IPv4 address in the <i>IPv4 Firewall Configuration</i> and an IPv6 address in the <i>IPv6 Firewall Configuration</i> .
Protocol	Specifies the protocol to which the rule applies: <ul style="list-style-type: none"> • all – The rule applies to all protocols, including those not listed below. • TCP – The rule applies to the TCP protocol. • UDP – The rule applies to the UDP protocol. • GRE – The rule applies to the GRE protocol. • ESP – The rule applies to the ESP protocol. • ICMP/ICMPv6 – The rule applies to the ICMP protocol. In the <i>IPv6 Firewall Configuration</i>, there is an option for ICMPv6.
Target Port(s)	Specifies the target port numbers. Enter the initial and final port numbers separated by a hyphen. A single static port can also be specified.
Action	Defines the action the router performs based on the rule: <ul style="list-style-type: none"> • allow – The router permits the packets to be forwarded. • deny – The router blocks the packets from being forwarded.
Description	A user-defined description of the rule.

Table 37: Forward Filtering

When the *Enable filtering of locally destined packets* function is enabled, the router automatically drops packets requesting an unsupported service without sending any notification.

To protect against DoS attacks, the *Enable protection against DoS attacks* option limits the number of allowed connections per second to five. A DoS attack floods the target system with excessive requests, overwhelming its resources.

¹This field supports IP address input in the formats: `IP` , `IP/mask` , or `IP_start-IP_end` .

3.12.1 Example of the IPv4 Firewall Configuration

The router permits the following access:

- Access from IP address 198.51.100.45 using any protocol.
- Access from the IP address range 192.0.2.123 to 192.0.3.127 using the TCP protocol on port 1000.
- Access from IP address 203.0.113.67 using the ICMP protocol.
- Access from IP address 203.0.113.67 using the TCP protocol on target ports ranging from 1020 to 1040.

See the network topology and configuration form in the figures below.

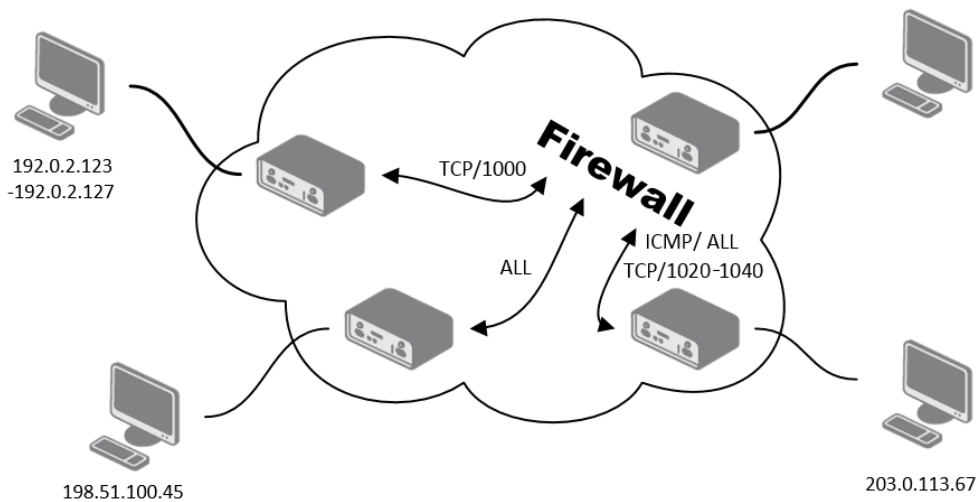

Figure 52: Topology for the IPv4 Firewall Configuration Example

IPv4 Firewall Configuration						
<input checked="" type="checkbox"/> Enable filtering of incoming packets						
	Source *	Protocol	Target Port(s) *	Action	Description *	
1	<input checked="" type="checkbox"/> 198.51.100.45	all		allow		
2	<input checked="" type="checkbox"/> 192.0.2.123-192.0.2.127	TCP	1000	allow		
3	<input checked="" type="checkbox"/> 203.0.113.67	ICMP		allow		
4	<input checked="" type="checkbox"/> 203.0.113.67	TCP	1020-1040	allow		
5	<input type="checkbox"/>	all		allow		
6	<input type="checkbox"/>	all		allow		
Maximum 32 items						
<input type="checkbox"/> Enable filtering of forwarded packets						
	Source *	Destination *	Protocol	Target Port(s) *	Action	Description *
1	<input type="checkbox"/>		all		allow	
2	<input type="checkbox"/>		all		allow	
Maximum 32 items						
<input type="checkbox"/> Enable filtering of locally destined packets						
<input type="checkbox"/> Enable protection against DoS attacks						
* can be blank						
<input type="button" value="Apply"/>						

Figure 53: IPv4 Firewall Configuration Example

3.12.2 Sites



This feature works only if the device is using the router as its DNS server.

On the *Sites* configuration page, you can define URL addresses to be blocked by the firewall (see Figure 54). To enable site blocking, tick the *Enable sites blocking* checkbox and enter the URL addresses in the *Block list* box, placing each address on a separate line. You can also use the *Load From File...* button to import addresses from a plain text file.

Sites Blocking Configuration

Enable sites blocking

Block list

```
https://www.example.com
http://www.socialmedia.com
https://www.streaming-site.comobsahem.
https://www.gambling.com
http://www.malicious-site.com
```

Load From File...

Apply

Figure 54: Firewall Sites Configuration GUI

3.13 NAT

To configure the address translation function, navigate to *NAT* under the *Configuration* section of the main menu, then select either the *IPv4* or *IPv6* subpage. The NAT IPv4 configuration page is shown in Figure 55. Separate NAT configuration options are available for IPv4 and IPv6, as the router supports dual-stack operation. The configuration fields are consistent across both IPv4 and IPv6 pages.

The router utilizes Port Address Translation (PAT), a technique that maps one TCP/UDP port to another by modifying the packet header as packets pass through. This configuration form allows you to define up to sixty-four PAT rules. A new row for defining the next rule appears automatically after filling in the previous one. Table 38 describes the fields used for specifying these rules.

Item	Description
Public Port(s)	Defines the range of public port numbers for NAT. Enter the initial and final port numbers separated by a hyphen. A single static port can also be specified.
Private Port(s)	Defines the range of private port numbers for NAT. Enter the initial and final port numbers separated by a hyphen. A single static port can also be specified.
Type	Specifies the protocol type: TCP or UDP.
Server IP Address	(NAT IPv4 only) Specifies the IPv4 address to which the router forwards incoming traffic.
Server IPv6 Address	(NAT IPv6 only) Specifies the IPv6 address to which the router forwards incoming traffic.
Description	A user-defined description of the rule.

Table 38: NAT Configuration Items Description

If you require more than sixty-four NAT rules, you can add the additional rules to the Startup Script. The *Startup Script* dialog is located on the *Scripts* page under the *Configuration* section of the menu. To define NAT rules in the Startup Script, use the following command for IPv4 NAT:



```
iptables -t nat -A pre_nat -p tcp --dport [PORT_PUBLIC] -j DNAT
--to-destination [IPADDR]:[PORT_PRIVATE]
```

Replace the placeholders as follows:

[IPADDR] – The destination IP address.

[PORT_PUBLIC] – The public port number.

[PORT_PRIVATE] – The private port number.

For IPv6 NAT, use the `ip6tables` command with the same options:



```
ip6tables -t nat -A napt -p tcp --dport [PORT_PUBLIC] -j DNAT
--to-destination [IP6ADDR]:[PORT_PRIVATE]
```

If you enable the following options and specify a port number, the router allows remote access from the WAN (Mobile WAN) interface.

IPv4 NAT Configuration					
	Public Port(s)	Private Port(s)	Type	Server IP Address	Description *
1	<input type="text"/>	<input type="text"/>	TCP ▾	<input type="text"/>	<input type="text"/>
2	<input type="text"/>	<input type="text"/>	TCP ▾	<input type="text"/>	<input type="text"/>
Maximum 64 items					
<input type="checkbox"/>	Enable remote HTTP access on port	<input type="text" value="80"/>			
<input checked="" type="checkbox"/>	Enable remote HTTPS access on port	<input type="text" value="443"/>			
<input type="checkbox"/>	Enable remote FTP access on port	<input type="text" value="21"/>			
<input checked="" type="checkbox"/>	Enable remote SSH access on port	<input type="text" value="22"/>			
<input type="checkbox"/>	Enable remote Telnet access on port	<input type="text" value="23"/>			
<input checked="" type="checkbox"/>	Enable remote SNMP access on port	<input type="text" value="161"/>			
<input type="checkbox"/> Send all remaining incoming packets to default server					
Default Server IP Address <input type="text"/>					
<input checked="" type="checkbox"/> Masquerade outgoing packets					
<input type="checkbox"/> Enable SIP ALG					
<input checked="" type="checkbox"/>	Enable FTP Helper on public port(s)	<input type="text" value="21"/>			
<input type="checkbox"/>	Enable PPTP Helper on public port(s)	<input type="text" value="1723"/>			
* can be blank					
<input type="button" value="Apply"/>					

Figure 55: NAT IPv4 Configuration Page

The next section allows enabling or disabling access to common protocols on specific ports. See Table 39 for details.

Item	Description
Enable remote HTTP access on port	This option redirects HTTP traffic to HTTPS only .
Enable remote HTTPS access on port	If enabled and a port number is specified, the router's web interface can be accessed remotely.
Enable remote FTP access on port	Allows remote access to the router via FTP.
Enable remote SSH access on port	Allows remote access to the router via SSH.
Enable remote Telnet access on port	Allows remote access to the router via Telnet.
Enable remote SNMP access on port	Allows remote access to the router via SNMP.

Table 39: Remote Access Configuration

! *Enable remote HTTP access on port* only redirects HTTP traffic to HTTPS and does not allow unsecured HTTP access to the web configuration. To configure the web interface, always enable *HTTPS access*. Never enable HTTP alone for Internet access; always enable HTTPS or both HTTP and HTTPS for redirection.

Parameters for routing incoming data from the WAN (Mobile WAN) to a connected computer are listed in Table 40.

Item	Description
Send all remaining incoming packets to default server	Enables forwarding of unmatched incoming packets to the default server specified in the <i>Default Server IPv4/IPv6 Address</i> field. This setting forwards data from the mobile WAN to the assigned IP address.
Default Server IPv4/IPv6 Address	Specifies the IPv4/IPv6 address of the default server.

Table 40: Incoming Packets Configuration

The configuration options for NAT helpers, which assist with handling specific protocols, are described in Table 41. These options improve packet forwarding and connection stability for services such as FTP and VPN when NAT is in use.

Item	Description
Enable NAT64	(NAT IPv6 only) Activates the NAT64 interface, serving as an internal translator gateway between IPv6 and IPv4 addresses. Note: Ensure that the predefined <i>Default rule for NAT64</i> is enabled in <i>Firewall → IPv6</i> for proper functionality.
Masquerade outgoing packets	Enables Network Address Translation (NAT) for outgoing packets. This ensures that all outgoing traffic appears to originate from the router's external IP address, concealing the internal network structure.
Enable SIP ALG	(NAT IPv4 only) Enables the SIP Application Layer Gateway (ALG). When enabled, the router modifies SIP packets to facilitate proper NAT traversal, which is essential for VoIP traffic.
Enable FTP Helper on public port(s)	Assists in handling FTP traffic on the specified public port (default: 21). The FTP Helper improves FTP traffic traversal through NAT, particularly for active FTP sessions.
Enable PPTP Helper on public port(s)	(NAT IPv4 only) Enables the PPTP (Point-to-Point Tunneling Protocol) Helper for VPN traffic on the specified public port (default: 1723). The PPTP Helper ensures proper NAT handling for PPTP connections.

Table 41: Related Features Configuration

The NAT64 functionality utilizes the *Jool* implementation. Due to limitations in Jool, it is not possible to connect to the router performing NAT64 translation using the router's IPv4 address mapped into IPv6.

For example, if the router has the IP addresses `192.0.2.1/24` and `2001:db8::1/64`, you can access the router using both IPv4 and IPv6 addresses. However, the NAT64-mapped address `64:ff9b::192.0.2.1` will not work.

Additionally, the firewall must explicitly allow such incoming connections. The permitted address must be specified in the incoming packets firewall rules rather than the forwarding rules because Jool drops incoming packets and recreates outgoing packets.

3.13.1 Examples of NAT Configuration

Example 1: IPv4 NAT Configuration with Single Device Connected

For this configuration, it is essential to enable the *Send all remaining incoming packets to default server* option. The IP address specified in this setting should correspond to the device located behind the router.

Additionally, the default gateway of the devices within the subnet connected to the router must match the IP address displayed in the *Default Server IP Address* field. When properly configured, the connected device will respond to a PING request sent to the IP address assigned to the SIM card.

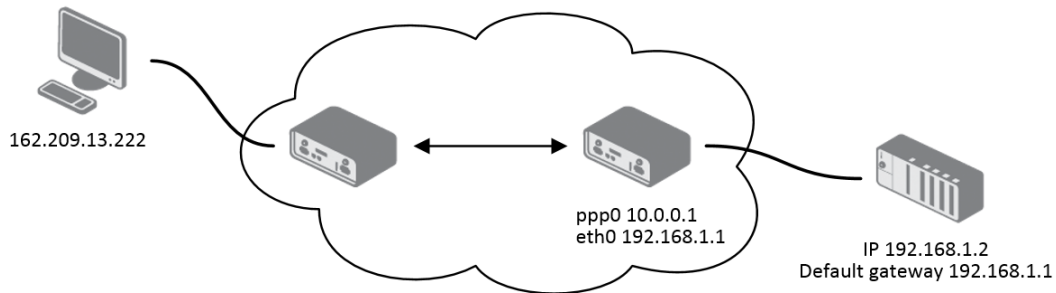

Figure 56: Topology for NAT Configuration Example 1

IPv4 NAT Configuration					
	Public Port(s)	Private Port(s)	Type	Server IP Address	Description *
1	<input type="text"/>	<input type="text"/>	TCP ▾	<input type="text"/>	<input type="text"/>
2	<input type="text"/>	<input type="text"/>	TCP ▾	<input type="text"/>	<input type="text"/>
Maximum 64 items					
<input type="checkbox"/>	Enable remote HTTP access on port	<input type="text" value="80"/>			
<input type="checkbox"/>	Enable remote HTTPS access on port	<input type="text" value="443"/>			
<input type="checkbox"/>	Enable remote FTP access on port	<input type="text" value="21"/>			
<input type="checkbox"/>	Enable remote SSH access on port	<input type="text" value="22"/>			
<input type="checkbox"/>	Enable remote Telnet access on port	<input type="text" value="23"/>			
<input checked="" type="checkbox"/>	Enable remote SNMP access on port	<input type="text" value="161"/>			
<input checked="" type="checkbox"/>	Send all remaining incoming packets to default server				
	Default Server IP Address	<input type="text" value="192.168.1.2"/>			
<input checked="" type="checkbox"/>	Masquerade outgoing packets				
<input type="checkbox"/>	Enable SIP ALG				
<input checked="" type="checkbox"/>	Enable FTP Helper on public port(s)	<input type="text" value="21"/>			
<input type="checkbox"/>	Enable PPTP Helper on public port(s)	<input type="text" value="1723"/>			
* can be blank					
<input type="button" value="Apply"/>					

Figure 57: NAT Configuration for Example 1

Example 2: IPv4 NAT Configuration with Multiple Devices Connected

In this example, a switch is used to connect multiple devices behind the router. Each device has its own IP address. To configure port forwarding, enter the device’s IP address in the *Server IP Address* field within the *NAT* dialog.

The devices communicate on port 80, but you can specify different public and private ports using the *Public Port* and *Private Port* fields in the NAT dialog. This setup enables access to the internal socket 192.168.1.2:80 from the Internet by using the router’s public IP address 10.0.0.1:81.

If you send a ping request to the router’s public IP address (10.0.0.1), the router responds as usual without forwarding the request. Since the *Send all remaining incoming packets to default server* option is inactive, the router denies any other connection attempts.

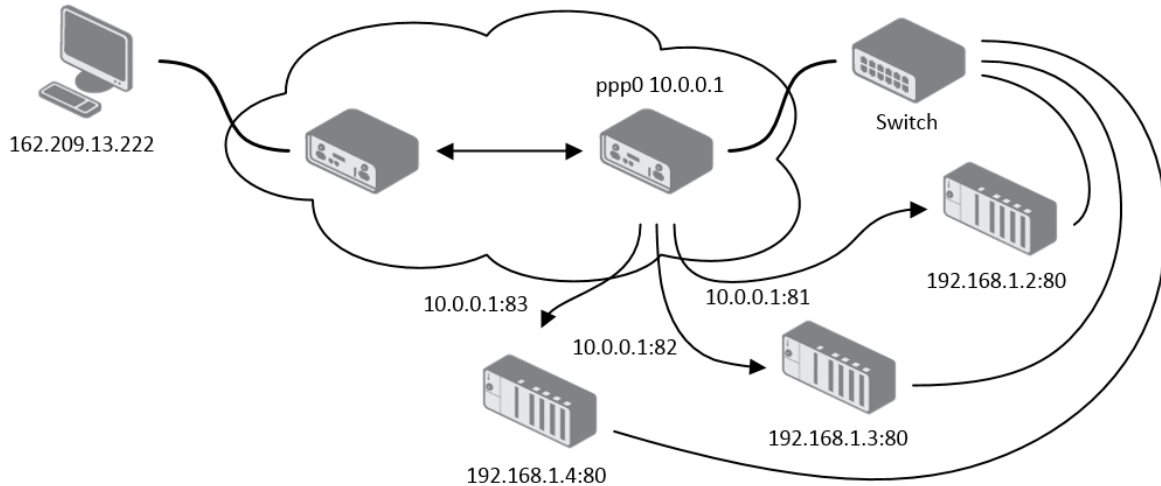

Figure 58: Topology for NAT Configuration Example 2

IPv4 NAT Configuration					
	Public Port(s)	Private Port(s)	Type	Server IP Address	Description *
1	81	80	TCP	192.168.1.2	
2	82	80	TCP	192.168.1.3	
3	83	80	TCP	192.168.1.4	
4			TCP		
5			TCP		
Maximum 64 items					
<input type="checkbox"/> Enable remote HTTP access on port <input type="text" value="80"/>					
<input type="checkbox"/> Enable remote HTTPS access on port <input type="text" value="443"/>					
<input type="checkbox"/> Enable remote FTP access on port <input type="text" value="21"/>					
<input type="checkbox"/> Enable remote SSH access on port <input type="text" value="22"/>					
<input type="checkbox"/> Enable remote Telnet access on port <input type="text" value="23"/>					
<input checked="" type="checkbox"/> Enable remote SNMP access on port <input type="text" value="161"/>					
<input type="checkbox"/> Send all remaining incoming packets to default server Default Server IP Address <input type="text"/>					
<input checked="" type="checkbox"/> Masquerade outgoing packets					
<input type="checkbox"/> Enable SIP ALG					
<input checked="" type="checkbox"/> Enable FTP Helper on public port(s) <input type="text" value="21"/>					
<input type="checkbox"/> Enable PPTP Helper on public port(s) <input type="text" value="1723"/>					
* can be blank <input type="button" value="Apply"/>					

Figure 59: NAT Configuration for Example 2

3.14 OpenVPN

Select the *OpenVPN* item to configure an OpenVPN tunnel. The menu item will expand and you will see separate configuration pages: *1st Tunnel*, *2nd Tunnel*, *3rd Tunnel* and *4th Tunnel*. The OpenVPN tunnel function allows you to create a secure connection between two separate LAN networks. The router allows you to create up to **four OpenVPN tunnels**. IPv4 and IPv6 dual stack is supported.

Item	Description
Description	Specifies the description or name of tunnel.
Interface Type	TAP is basically at the Ethernet level (layer 2) and acts as a switch, whereas TUN works at the network level (layer 3) and routes packets on the VPN. TAP is bridging, whereas TUN is routing. <ul style="list-style-type: none"> • TUN – Choose the TUN mode. • TAP – Choose the TAP mode, but remember first to configure the bridge on the ethernet interface.
Protocol	Specifies the communication protocol. <ul style="list-style-type: none"> • UDP – The OpenVPN communicates using UDP. • TCP server – The OpenVPN communicates using TCP in server mode. • TCP client – The OpenVPN communicates using TCP in client mode. • UDPv6 – The OpenVPN communicates using UDP over IPv6. • TCPv6 server – The OpenVPN communicates using TCP over IPv6 in server mode. • TCPv6 client – The OpenVPN communicates using TCP over IPv6 in client mode.
UDP/TCP port	Specifies the port of the relevant protocol (UDP or TCP).
1st Remote IP Address	Specifies the first IPv4, IPv6 address or domain name of the opposite side of the tunnel.
2nd Remote IP Address	Specifies the second IPv4, IPv6 address or domain name of the opposite side of the tunnel.
Remote Subnet	IPv4 address of a network behind opposite side of the tunnel.
Remote Subnet Mask	IPv4 subnet mask of a network behind opposite tunnel's side.
Redirect Gateway	Adds (rewrites) the default gateway. All the packets are then sent to this gateway via tunnel, if there is no other specified default gateway inside them.
Local Interface IP Address	Specifies the IPv4 address of a local interface. For proper routing it is recommended to fill-in any IPv4 address from local range even if you are using IPv6 tunnel only.
Remote Interface IP Address	Specifies the IPv4 address of the interface of opposite side of the tunnel. For proper routing it is recommended to fill-in any IPv4 address from local range even if you are using IPv6 tunnel only.
Remote IPv6 Subnet	IPv6 address of the remote IPv6 network. Equivalent of the <i>Remote Subnet</i> in IPv4 section.

Continued on next page

Continued from previous page

Item	Description
Remote IPv6 Prefix	IPv6 prefix of the remote IPv6 network. Equivalent of the <i>Remote Subnet Mask</i> in IPv4 section.
Local Interface IPv6 Address	Specifies the IPv6 address of a local interface.
Remote Interface IPv6 Address	Specifies the IPv6 address of the interface of opposite side of the tunnel.
Ping Interval	Time interval after which the router sends a message to opposite side of tunnel to verify the existence of the tunnel.
Ping Timeout	Specifies the time interval the router waits for a message sent by the opposite side. For proper verification of the OpenVPN tunnel, set the <i>Ping Timeout</i> to greater than the <i>Ping Interval</i> .
Renegotiate Interval	Specifies the renegotiate period (reauthorization) of the OpenVPN tunnel. You can only set this parameter when the <i>Authenticate Mode</i> is set to <i>username/password</i> or <i>X.509 certificate</i> . After this time period, the router changes the tunnel encryption to keep the tunnel secure.
Max Fragment Size	Maximum size of a sent packet.
Compression	Compression of the data sent: <ul style="list-style-type: none"> • none – No compression is used. • LZO – A lossless compression is used, use the same setting on both sides of the tunnel.
NAT Rules	Activates/deactivates the NAT rules for the OpenVPN tunnel: <ul style="list-style-type: none"> • not applied – NAT rules are not applied to the tunnel. • applied – NAT rules are applied to the OpenVPN tunnel.
Authenticate Mode	Specifies the authentication mode: <ul style="list-style-type: none"> • none – No authentication is set. • Pre-shared secret – Specifies the shared key function for both sides of the tunnel. • Username/password – Specifies authentication using a CA Certificate, Username and Password. • X.509 Certificate (multiclient) – Activates the X.509 authentication in multi-client mode. • X.509 Certificate (client) – Activates the X.509 authentication in client mode. • X.509 Certificate (server) – Activates the X.509 authentication in server mode.
Security Mode	Choose the security mode, <i>tls-auth</i> or <i>tls-crypt</i> . We recommend to use the <i>tls-crypt</i> mode for the security reasons. In this mode, all the data is encrypted with a pre-shared key. Moreover, this mode is more robust against the TLS denial of service attacks.

Continued on next page

Continued from previous page

Item	Description
Pre-shared Secret	Specifies the pre-shared secret which you can use for every authentication mode.
CA Certificate	Specifies the CA Certificate which you can use for the username/password and X.509 Certificate authentication modes.
DH Parameters	Specifies the protocol for the DH parameters key exchange which you can use for X.509 Certificate authentication in the server mode.
Local Certificate	Specifies the certificate used in the local device. You can use this authentication certificate for the X.509 Certificate authentication mode.
Local Private Key	Specifies the key used in the local device. You can use the key for the X.509 Certificate authentication mode.
Local Passphrase	Passphrase used during private key generation.
Username	Specifies a login name which you can use for authentication in the username/password mode.
Password	Specifies a password which you can use for authentication in the username/password mode. Enter valid characters only, see chap. 1.2.1.
Security Level	Set the Security Level ¹ : <ul style="list-style-type: none"> • 0 - Weak – [Default] Everything is permitted. This setting is not recommended; it is advisable to set a higher security level! • 1 - Low – 80 bits of security. • 2 - Medium – 112 bits of security. • 3 - High – 128 bits of security. • 4 - Very High – 192 bits of security.
User's Up Script	Custom script, executed when the OpenVPN tunnel is established.
User's Down Script	Custom script, executed when the OpenVPN tunnel is closed.
Extra Options	Specifies additional parameters for the OpenVPN tunnel, such as DHCP options. The parameters are preceded by two dashes. For possible parameters see the help text in the router using SSH – run the <code>openvpnd --help</code> command.

Table 42: OpenVPN Configuration Items Description



There is a condition for tunnel to be established: WAN route has to be active (for example mobile connection established) even if the tunnel does not go through the WAN.

The changes in settings will apply after pressing the *Apply* button.

¹For detailed explanation see the *Security Guidelines* [15], specifically the chapter on *Cryptographic algorithms*.

²Parameters passed to the script are `cmd tun_dev tun_mtu link_mtu ifconfig_local_ip ifconfig_remote_ip [init | restart]`, see *Reference manual for OpenVPN*, option `-up` cmd.

1st OpenVPN Tunnel Configuration	
<input type="checkbox"/> Create 1st OpenVPN tunnel	
Description *	<input type="text"/>
Interface Type	TUN ▼
Protocol	UDP ▼
UDP Port	1194
1st Remote IP Address *	<input type="text"/>
2nd Remote IP Address *	<input type="text"/>
Remote Subnet *	<input type="text"/>
Remote Subnet Mask *	<input type="text"/>
Redirect Gateway	no ▼
Local Interface IP Address	<input type="text"/>
Remote Interface IP Address	<input type="text"/>
Remote IPv6 Subnet *	<input type="text"/>
Remote IPv6 Subnet Prefix Length *	<input type="text"/>
Local Interface IPv6 Address *	<input type="text"/>
Remote Interface IPv6 Address *	<input type="text"/>
Ping Interval *	<input type="text"/> sec
Ping Timeout *	<input type="text"/> sec
Renegotiate Interval *	<input type="text"/> sec
Max Fragment Size *	<input type="text"/> bytes
Compression	LZO ▼
NAT Rules	not applied ▼
Authenticate Mode	none ▼
Security Mode	tls-auth ▼
Pre-shared Secret	<input type="text"/>
CA Certificate	<input type="text"/>
DH Parameters	<input type="text"/>
Local Certificate	<input type="text"/>
Local Private Key	<input type="text"/>
Local Passphrase *	<input type="text"/>
Username	<input type="text"/>
Password	<input type="text"/>
Security Level	0 - Weak ▼
User's Up Script	<pre>#!/bin/sh # # This script will be executed when OpenVPN tunnel is up.</pre>
User's Down Script	<pre>#!/bin/sh # # This script will be executed when OpenVPN tunnel is down.</pre>
Extra Options *	<input type="text"/>
<i>* can be blank</i>	
<input type="button" value="Apply"/>	

Figure 60: OpenVPN tunnel configuration Page

3.14.1 Example of the OpenVPN Tunnel Configuration in IPv4 Network

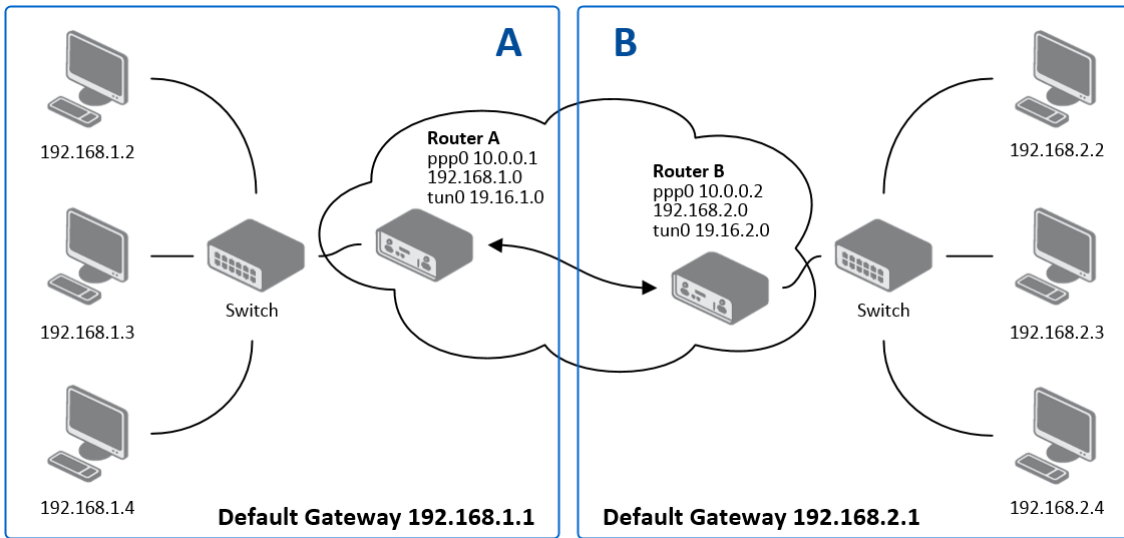

Figure 61: Topology of OpenVPN Configuration Example

OpenVPN tunnel configuration:

Configuration	A	B
Protocol	UDP	UDP
UDP Port	1194	1194
Remote IP Address	10.0.0.2	10.0.0.1
Remote Subnet	192.168.2.0	192.168.1.0
Remote Subnet Mask	255.255.255.0	255.255.255.0
Local Interface IP Address	19.16.1.0	19.16.2.0
Remote Interface IP Address	19.16.2.0	19.16.1.0
Compression	LZO	LZO
Authenticate mode	none	none

Table 43: OpenVPN Configuration Example



Examples of different options for configuration and authentication of OpenVPN tunnel can be found in the application note *OpenVPN Tunnel* [5].

3.15 IPsec

The IPsec tunnel function allows you to create a secured connection between two separate LAN networks. These router family allows you to create **up to four IPsec tunnels**.

To open the IPsec tunnel configuration page, click *IPsec* in the *Configuration* section of the main menu. The menu item will expand and you will see separate configuration pages: *1st Tunnel*, *2nd Tunnel*, *3rd Tunnel* and *4th Tunnel*.

Supported are both, **policy-based** and **route-based** VPN approaches, see the different configuration scenarios in Chapter 3.15.1.

IPv4 and IPv6 tunnels are supported (**dual stack**), you can transport IPv6 traffic through IPv4 tunnel and vice versa. For different IPsec authentication scenarios, see Chapter 3.15.2.



To encrypt data between the local and remote subnets, specify the appropriate values in the subnet fields on both routers. To encrypt the data stream between the routers only, leave the local and remote subnets fields blank.



If you specify the protocol and port information in the *Local Protocol/Port* field, then the router encapsulates only the packets matching the settings.



For optimal an secure setup, we recommend to follow instructions on the [Security Recommendations strongSwan](#) web page.



Detailed information and more examples of IPsec tunnel configuration and authentication can be found in the application note *IPsec Tunnel* [6].



FRRouting (FRR) router app is an Internet routing protocol suite for Advantech routers. This UM includes protocol daemons for BGP, IS-IS, LDP, OSPF, PIM, and RIP.

3.15.1 Route-based Configuration Scenarios

There are more different route-based configuration options which can be configured and used in Advantech routers. Below are listed the most common cases which can be used (for more details see [Route-based VPNs strongSwan](#) web page):

1. Enabled Installing Routes

- Remote (local) subnets are used as traffic selectors (routes).
- It results to the same outcome as a policy-based VPN.
- One benefit of this approach is the possibility to verify non-encrypted traffic passed through an IPsec tunnel number X by tcdump tool: `tcdump -i ipsecX`.
- Set up the *Install Routes* to *yes* option.

2. Static Routes

- Routes are installed statically by an application as soon as the IPsec tunnel is up.
- As an application for static routes installation can be used for example FRR/STATICD application.
- Set up the *Install Routes* to *no* option.

3. Dynamic Routing

- Routes are installed dynamically while running by an application using a dynamic protocol.
- As an application for dynamic routes installation can be used for example FRR/BGP or FRR/OSPF application. This application gains the routes dynamically from an (BGP, OSPF) server.
- Set up the *Install Routes* to *no* option.

4. Multiple Clients

- Allows to create VPN network with multiple clients. One Advantech router acts as the server and assigns IP address to all the clients on the network.
- The server has *Remote Virtual Network* and *Remote Virtual Mask* items configured and the client has *Local Virtual Address* item configured.
- Set up the *Install Routes* to *yes* option.

3.15.2 IPsec Authentication Scenarios

There are four basic authentication options which can be configured and used in Advantech routers:

1. Pre-shared Key

- Set *Authenticate Mode* to *pre-shared key* option.
- Enter the shared key to the *Pre-shared key* field.

2. Public Key

- Set *Authenticate Mode* to *X.509 certificate* option.
- Enter the public key to the *Local Certificate / PubKey* field.
- CA certificate is not required.

3. Peer Certificate

- Set *Authenticate Mode* to *X.509 certificate* option.
- Enter the remote key to the *Remote Certificate / PubKey* field. Users with this certificate will be allowed.
- CA certificate is not required.

4. CA Certificate

- Set *Authenticate Mode* to *X.509 certificate* option.
- Enter the CA certificate or a list of CA certificates to the *CA Certificate* field. Any certificate signed by the CA will be accepted.
- Remote certificate is not required.

Notes:

- The Peer and CA Certificate (options 3 and 4) can be configured and used simultaneously – authentication can be done by one of this method.
- The Local ID is significant. When using certificate authentication, the IKE identity must be contained in the certificate, either as subject or as *subjectAltName*.

3.15.3 Configuration Items Description

The configuration GUI for IPsec is shown in Figure 62 and the description of all items, which can be configured for an IPsec tunnel, are described in Table 44.

1st IPsec Tunnel Configuration	
<input type="checkbox"/> Create 1st IPsec tunnel	
Description *	<input type="text"/>
Type	policy-based
Host IP Mode	IPv4
1st Remote IP Address *	<input type="text"/>
2nd Remote IP Address *	<input type="text"/>
Tunnel IP Mode	IPv4
Remote ID *	<input type="text"/>
Local ID *	<input type="text"/>
Install Routes	yes
First Remote Subnet *	<input type="text"/>
First Remote Subnet Mask *	<input type="text"/>
Second Remote Subnet *	<input type="text"/>
Second Remote Subnet Mask *	<input type="text"/>
Remote Protocol/Port *	<input type="text"/>
First Local Subnet *	<input type="text"/>
First Local Subnet Mask *	<input type="text"/>
Second Local Subnet *	<input type="text"/>
Second Local Subnet Mask *	<input type="text"/>
Local Protocol/Port *	<input type="text"/>
MTU	1426 bytes
Remote Virtual Network *	<input type="text"/>
Remote Virtual Mask *	<input type="text"/>
Local Virtual Address *	<input type="text"/>
Cisco FlexVPN **	no
Encapsulation Mode	tunnel
Force NAT Traversal	no
IKE Protocol	IKEv1
IKE Mode	main
IKE Algorithm	auto
IKE Encryption	3DES
IKE Hash	MD5
IKE DH Group	2
IKE Reauthentication	yes
XAUTH Enabled	no
XAUTH Mode	client
XAUTH Username	<input type="text"/>
XAUTH Password	<input type="password"/>
ESP Algorithm	auto
ESP Encryption	DES
ESP Hash	MD5
PFS	disabled
PFS DH Group	2
Key Lifetime	3600 sec
IKE Lifetime	3600 sec
Rekey Margin	540 sec
Rekey Fuzz	100 %
DPD Delay *	<input type="text"/> sec
DPD Timeout *	<input type="text"/> sec
Authenticate Mode	pre-shared key
Pre-shared Key	<input type="password"/>
Remote Pre-shared Key *	<input type="text"/>
CA Certificate *	<input type="text"/> Choose File No file chosen
Remote Certificate / PubKey *	<input type="text"/> Choose File No file chosen
Local Certificate / PubKey	<input type="text"/> Choose File No file chosen
Local Private Key	<input type="text"/> Choose File No file chosen
Local Passphrase *	<input type="text"/>
Revocation Check	if possible
User's Up Script	<pre>#!/bin/sh # # This script will be executed...</pre>
User's Down Script	<pre>#!/bin/sh # # This script will be executed...</pre>
Debug **	control
* can be blank ** affects all tunnels	
Apply	

Figure 62: IPsec Tunnels Configuration Page

Item	Description
Description	Name or description of the tunnel.
Type	<ul style="list-style-type: none"> • policy-based – Choose for the policy-based VPN approach. • route-based – Choose for the route-based VPN approach. Note: Data throughput via route-based VPN is slightly lower in comparison with policy-based VPN.
Host IP Mode	<ul style="list-style-type: none"> • IPv4 – The router communicates via IPv4 with the opposite side of the tunnel. • IPv6 – The router communicates via IPv6 with the opposite side of the tunnel.
1st Remote IP Address	First IPv4, IPv6 address or domain name of the remote side of the tunnel, based on selected <i>Host IP Mode</i> above.
2nd Remote IP Address	Second IPv4, IPv6 address or domain name of the remote side of the tunnel, based on selected <i>Host IP Mode</i> above.
Tunnel IP Mode	<ul style="list-style-type: none"> • IPv4 – The IPv4 communication runs inside the tunnel. • IPv6 – The IPv6 communication runs inside the tunnel.
Remote ID	Identifier (ID) of remote side of the tunnel. It consists of two parts: a <i>hostname</i> and a <i>domain-name</i> .
Local ID	Identifier (ID) of local side of the tunnel. It consists of two parts: a <i>hostname</i> and a <i>domain-name</i> .
Install Routers	For route-based type only. Choose yes to use traffic selectors as route(s).
First Remote Subnet	IPv4 or IPv6 address of a network behind remote side of the tunnel, based on <i>Tunnel IP Mode</i> above.
First Remote Subnet Mask/Prefix	IPv4 subnet mask of a network behind remote side of the tunnel, or IPv6 prefix (single number 0 to 128).
Second Remote Subnet	IPv4 or IPv6 address of the second network behind remote side of the tunnel, based on <i>Tunnel IP Mode</i> above. For <i>IKE Protocol</i> = IKEv2 only.
Second Remote Subnet Mask/Prefix	IPv4 subnet mask of the second network behind remote side of the tunnel, or IPv6 prefix (single number 0 to 128). For <i>IKE Protocol</i> = IKEv2 only.
Remote Protocol/Port	Specifies Protocol/Port of remote side of the tunnel. The general form is <i>protocol/port</i> , for example 17/1701 for UDP (protocol 17) and port 1701. It is also possible to enter only the number of protocol, however, the above mentioned format is preferred.
First Local Subnet	IPv4 or IPv6 address of a local network, based on <i>Tunnel IP Mode</i> above.
First Local Subnet Mask/Prefix	IPv4 subnet mask of a local network, or IPv6 prefix (single number 0 to 128).
Second Local Subnet	IPv4 or IPv6 address of the second local network, based on <i>Tunnel IP Mode</i> above. For <i>IKE Protocol</i> = IKEv2 only.
Second Local Subnet Mask/Prefix	IPv4 subnet mask of the second local network, or IPv6 prefix (single number 0 to 128). For <i>IKE Protocol</i> = IKEv2 only.

Continued on next page

Continued from previous page

Item	Description
Local Protocol/Port	Specifies Protocol/Port of a local network. The general form is <i>protocol/port</i> , for example 17/1701 for UDP (protocol 17) and port 1701. It is also possible to enter only the number of protocol, however, the above mentioned format is preferred.
MTU	Maximum Transmission Unit value (for route-based mode only). Default value is 1426 bytes.
Remote Virtual Network	Specifies virtual remote network for server (responder).
Remote Virtual Mask	Specifies virtual remote network mask for server (responder).
Local Virtual Address	Specifies virtual local network address for client. To get address from server set up the address to 0.0.0.0.
Cisco FlexVPN	Enable to support the Cisco FlexVPN functionality. The <i>route-based</i> type must be chosen. For more information, see strongswan.conf page.
Encapsulation Mode	Specifies the IPsec mode, according to the method of encapsulation. <ul style="list-style-type: none"> • tunnel – entire IP datagram is encapsulated. • transport – only IP header is encapsulated. Not supported by route-based VPN. • beet – the ESP packet is formatted as a transport mode packet, but the semantics of the connection are the same as for tunnel mode.
Force NAT Traversal	Enable NAT traversal enforcement (UDP encapsulation of ESP packets).
IKE Protocol	Specifies the version of IKE (IKEv1/IKEv2 , IKEv1 or IKEv2).
IKE Mode	Specifies the mode for establishing a connection (<i>main</i> or <i>aggressive</i>). If you select the aggressive mode, then the router establishes the IPsec tunnel faster, but the encryption is permanently set to 3DES-MD5. We recommend that you not use the aggressive mode due to lower security!
IKE Algorithm	Specifies the means by which the router selects the algorithm: <ul style="list-style-type: none"> • auto – The encryption and hash algorithm are selected automatically. • manual – The encryption and hash algorithm are defined by the user.
IKE Encryption	Encryption algorithm – 3DES , AES128 , AES192 , AES256 , AES128GCM128 , AES192GCM128 , AES256GCM128 .
IKE Hash	Hash algorithm – MD5 , SHA1 , SHA256 , SHA384 or SHA512 .
IKE DH Group	Specifies the Diffie-Hellman groups which determine the strength of the key used in the key exchange process. Higher group numbers are more secure, but require more time to compute the key.
IKE Reauthentication	Enable or disable IKE reauthentication (for IKEv2 only).
XAUTH Enabled	Enable extended authentication (for IKEv1 only).
XAUTH Mode	Select XAUTH mode (client or server).
XAUTH Username	XAUTH username.
XAUTH Password	XAUTH password.

Continued on next page

Continued from previous page

Item	Description
ESP Algorithm	Specifies the means by which the router selects the algorithm: <ul style="list-style-type: none"> • auto – The encryption and hash algorithm are selected automatically. • manual – The encryption and hash algorithm are defined by the user.
ESP Encryption	Encryption algorithm – 3DES, AES128, AES192, AES256, AES128GCM128, AES192GCM128, AES256GCM128.
ESP Hash	Hash algorithm – MD5, SHA1, SHA256, SHA384 or SHA512.
PFS	Enables/disables the <i>Perfect Forward Secrecy</i> function. The function ensures that derived session keys are not compromised if one of the private keys is compromised in the future.
PFS DH Group	Specifies the Diffie-Hellman group number (see <i>IKE DH Group</i>).
Key Lifetime	Lifetime key data part of tunnel. The minimum value of this parameter is 60 s. The maximum value is 86400 s.
IKE Lifetime	Lifetime key service part of tunnel. The minimum value of this parameter is 60 s. The maximum value is 86400 s.
Rekey Margin	Specifies how long before a connection expires that the router attempts to negotiate a replacement. Specify a maximum value that is less than half of IKE and Key Lifetime parameters.
Rekey Fuzz	Percentage of time for the Rekey Margin extension.
DPD Delay	Time after which the IPsec tunnel functionality is tested.
DPD Timeout	The period during which device waits for a response.
Authenticate Mode	Specifies the means by which the router authenticates: <ul style="list-style-type: none"> • Pre-shared key – Sets the shared key for both sides of the tunnel. • X.509 Certificate – Allows X.509 authentication in multiclient mode.
(Local) Pre-shared Key	Specifies the shared key (local for IKEv2) for both sides of the tunnel. The prerequisite for entering a key is that you select pre-shared key as the authentication mode.
Remote Pre-shared Key	Specifies the remote shared key (for IKEv2) for both sides of the tunnel. The prerequisite for entering a key is that you select pre-shared key as the authentication mode.
CA Certificate	CA certificate chain for X.509 authentication. Specify the CA certificate or certificates used to validate the remote certificate.
Remote Certificate \ PubKey	Certificate for X.509 authentication or PubKey for public key signature authentication.
Local Certificate \ PubKey	Certificate for X.509 authentication or PubKey for public key signature authentication.
Local Private Key	Private key for X.509 authentication.
Local Passphrase	Passphrase used during private key generation.

Continued on next page

Continued from previous page

Item	Description
Revocation Check	Certificate revocation policy: <ul style="list-style-type: none"> • if possible – Fails only if a certificate is revoked, i.e. it is explicitly known that it is bad. • if URI defined – Fails only if a CRL/OCSP URI is available, but certificate revocation checking fails, i.e. there should be revocation information available, but it could not be obtained. • always – Fails if no revocation information is available, i.e. the certificate is not known to be unrevoked.
User's Up Script ¹	Custom script, executed when the IPsec tunnel is established.
User's Down Script ¹	Custom script, executed when the IPsec tunnel is closed.
Debug	Choose the level of logging verbosity from: silent , audit , control (default), control-more , raw , private (most verbose including the private keys). See Logger Configuration in <i>strongSwan</i> web page for more details.

Table 44: IPsec Tunnel Configuration Items Description

We recommend that you keep up the default settings. When you set key exchange times higher, the tunnel produces lower operating costs, but the setting also provides less security. Conversely, when you reducing the time, the tunnel produces higher operating costs, but provides for higher security. The changes in settings will apply after clicking the *Apply* button.

Do not miss:

- If local and remote subnets are not configured then only packets between local and remote IP address are encapsulated, so only communication between two routers is encrypted.
- If protocol/port fields are configured then only packets matching these settings are encapsulated.

¹Parameters passed to the script:

for policy-based type: one parameter: *connection name*, returns e.g. ipsec1-1,

for route-based type: two parameters: *connection name* and *interface name*, returns e.g. ipsec1-1 and ipsec0.

3.15.4 Basic IPv4 IPsec Tunnel Configuration

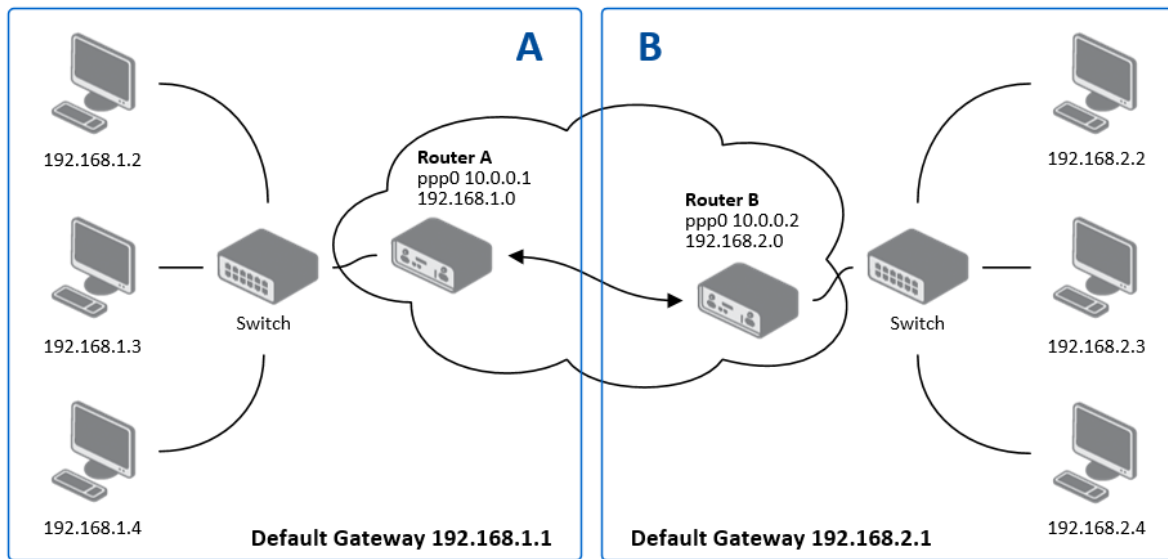

Figure 63: Topology of IPsec Configuration Example

Configuration of *Router A* and *Router B* is as follows:

Configuration	A	B
Host IP Mode	IPv4	IPv4
1st Remote IP Address	10.0.0.2	10.0.0.1
Tunnel IP Mode	IPv4	IPv4
First Remote Subnet	192.168.2.0	192.168.1.0
First Remote Subnet Mask	255.255.255.0	255.255.255.0
First Local Subnet	192.168.1.0	192.168.2.0
First Local Subnet Mask	255.255.255.0	255.255.255.0
Authenticate mode	pre-shared key	pre-shared key
Pre-shared key	test	test

Table 45: Simple IPv4 IPsec Tunnel Configuration

3.16 WireGuard

WireGuard is a communication protocol and free open-source software that implements encrypted virtual private networks (VPNs), and was designed with the goals of ease of use, high speed performance, and low attack surface. It aims for better performance and more power than IPsec and OpenVPN, two common tunneling protocols. The WireGuard protocol passes traffic over UDP. Advantech routers allows you to create **up to four WireGuard tunnels**.

To open the WireGuard tunnel configuration page, click *WireGuard* in the *Configuration* section of the main menu. The menu item will expand and you will see separate configuration pages: *1st Tunnel*, *2nd Tunnel*, *3rd Tunnel* and *4th Tunnel*.

IPv4 and IPv6 tunnels are supported (**dual stack**), you can transport IPv6 traffic through IPv4 tunnel and vice versa.



FRRouting (FRR) router app is an Internet routing protocol suite for Advantech routers. This UM includes protocol daemons for BGP, IS-IS, LDP, OSPF, PIM, and RIP.



Detailed information and more examples of WireGuard tunnel configuration and authentication can be found in the application note *WireGuard Tunnel* [8].

The configuration GUI for WireGuard is shown in Figure 64 and the description of all items, which can be configured for an WireGuard tunnel, are described in Table 46.

Item	Description
Description	Name or description of the tunnel.
Host IP Mode	<ul style="list-style-type: none"> ● IPv4 – The router communicates via IPv4 with the opposite side of the tunnel. ● IPv6 – The router communicates via IPv6 with the opposite side of the tunnel.
Remote IP Address	IPv4, IPv6 address or domain name of the remote side of the tunnel to connect to. The address must match with the selected <i>Host IP Mode</i> above.
Remote Port	Port of the remote side of the tunnel.
Local Port	Port of the local side of the tunnel (default port is 51820).
MTU	Maximum Transmission Unit value. Default value is 1400 bytes.
NAT/Firewall Traversal	If set up to <i>yes</i> , keepalive communication (every 25 seconds) is running to preserve the tunnel established. It is useful when a client is running behind the NAT.
Interface IPv4 Address	Local IPv4 tunnel interface address.
Interface IPv4 Prefix Length	Local IPv4 tunnel interface prefix.
Interface IPv6 Address	Local IPv6 tunnel interface address.
Interface IPv6 Prefix Length	Local IPv6 tunnel interface prefix.
Install Routes	<ul style="list-style-type: none"> ● no – Do not install routes. Use when a dynamic routing protocol is configured. ● yes – Install routes.
Traffic Selector	<ul style="list-style-type: none"> ● all traffic – Proceed all the packets to the WireGuard tunnel. ● subnets – Route based on the subnets listed below.
Remote Subnets	If the <i>Traffic Selector</i> is set to <i>subnets</i> , then other subnets (routes) can be routed through the wire tunnel.

Continued on next page

Continued from previous page

Item	Description
Pre-shared Key	The optional key for additional encryption layer and security strengthening. You can use the <i>Generate</i> button to generate a random key.
Local Private Key	The private key of the local side. You can use the <i>Generate</i> button to generate a random key.
Local Public Key	The public key of the local tunnel side.
Remote Public Key	The public key of the remote tunnel side.

Table 46: WireGuard Tunnel Configuration Items Description

The changes in settings will apply after clicking the *Apply* button.

1st WireGuard Tunnel Configuration

Create 1st WireGuard tunnel

Description *

Host IP Mode ▼

Remote IP Address *

Remote Port *

Local Port

MTU * bytes

NAT/Firewall Traversal ▼

Interface IPv4 Address *

Interface IPv4 Prefix Length *

Interface IPv6 Address *

Interface IPv6 Prefix Length *

Install Routes ▼

Traffic Selector ▼

Remote Subnets *

Pre-shared Key *

Local Private Key

Local Public Key *

Remote Public Key

* can be blank

Figure 64: WireGuard Tunnels Configuration Page

3.16.1 WireGuard IPv4 Tunnel Configuration Example

There is an example of WireGuard IPv4 tunnel configuration between *Router A* and *Router B*.

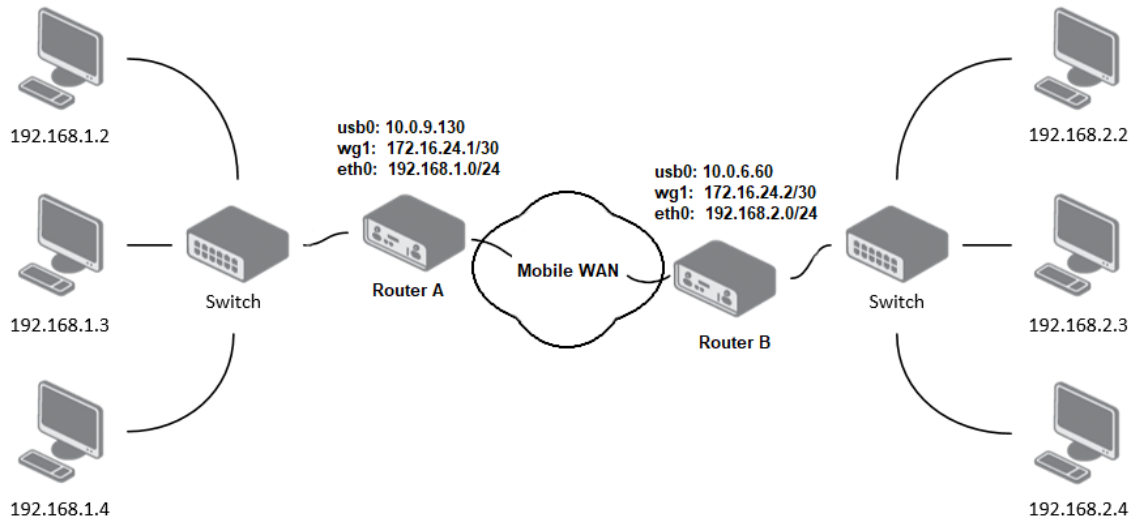

Figure 65: Topology of WireGuard Configuration Example

Router B is configured to listen, and *Router A* is the side initiating the tunnel connection. Configuration of *Router A* and *Router B* from the topology above is as follows:

Configuration	Router A	Router B
Host IP Mode	IPv4	IPv4
Remote IP Address	10.0.6.60	–
Remote Port	51820	–
Local Port	51820	51820
NAT/Firewall Traversal	yes	no
Interface IPv4 Address	172.16.24.1	172.16.24.2
Interface IPv4 Prefix Length	30	30
Install Routes	yes	yes
Traffic Selector	subnets	subnets
Remote Subnets	192.168.2.0/24	192.168.1.0/24
Local Private Key	local private key	local private key
Local Public Key	local public key	local public key
Remote Public Key	public key of the opposite side	public key of the opposite side

Table 47: WireGuard IPv4 Tunnel Configuration Example

In the figure below is the WireGuard status page of *Router A*. If the tunnel connection is established successfully, the *Latest handshake* time is shown here. This value is the time left from the latest successful communication with the opposite tunnel side. This item will not be shown here until there is a tunnel communication (data sent by the *Router A* or the keepalive data sent when *NAT/Firewall Traversal* is set to *yes*).

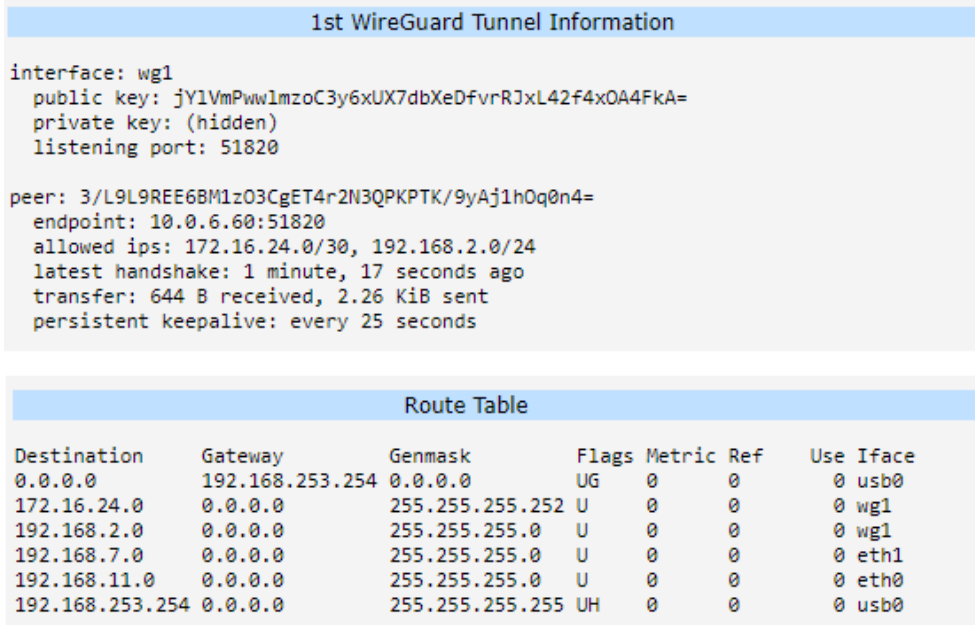

Figure 66: Router A – WireGuard Status Page and Route Table

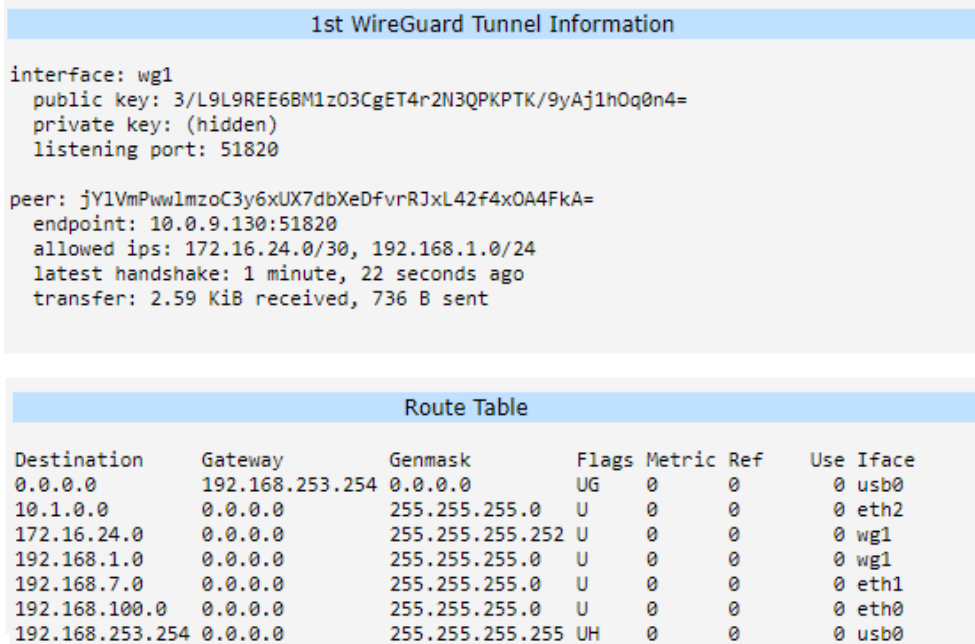

Figure 67: Router B – WireGuard Status Page and Route Table

3.17 GRE



GRE is an unencrypted protocol. GRE via IPv6 is not supported.

To open the *GRE Tunnel Configuration* page, click *GRE* in the *Configuration* section of the main menu. The menu item will expand and you will see separate configuration pages: *1st Tunnel*, *2nd Tunnel*, *3rd Tunnel* and *4th Tunnel*.

The GRE tunnel function allows you to create an unencrypted connection between two separate LAN networks. The router allows you to create **four GRE tunnels**.

Item	Description
Description	Description of the GRE tunnel.
Remote IP Address	IP address of the remote side of the tunnel.
Local IP Address	IP address of the local side of the tunnel.
Remote Subnet	IP address of the network behind the remote side of the tunnel.
Remote Subnet Mask	Specifies the mask of the network behind the remote side of the tunnel.
Local Interface IP Address	IP address of the local side of the tunnel.
Remote Interface IP Address	IP address of the remote side of the tunnel.
Multicasts	Activates/deactivates sending multicast into the GRE tunnel: <ul style="list-style-type: none"> • disabled – Sending multicast into the tunnel is inactive. • enabled – Sending multicast into the tunnel is active.
Pre-shared Key	Specifies an optional value for the 32 bit shared key in numeric format, with this key the router sends the filtered data through the tunnel. Specify the same key on both routers, otherwise the router drops received packets.

Table 48: GRE Tunnel Configuration Items Description



The GRE tunnel cannot pass through the NAT.

The changes in settings will apply after pressing the *Apply* button.

1st GRE Tunnel Configuration

Create 1st GRE tunnel

Description *

Remote IP Address *

Local IP Address *

Remote Subnet *

Remote Subnet Mask *

Local Interface IP Address *

Remote Interface IP Address *

Multicasts disabled ▼

Pre-shared Key *

** can be blank*

Figure 68: GRE Tunnel Configuration Page

3.17.1 Example of the GRE Tunnel Configuration

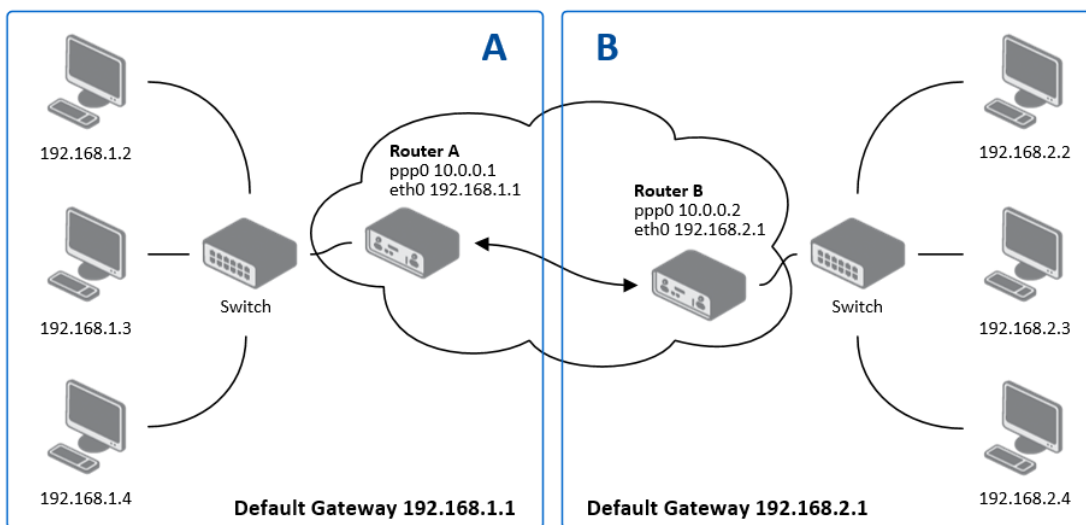

Figure 69: Topology of GRE Tunnel Configuration Example

GRE tunnel configuration:

Configuration	A	B
Remote IP Address	10.0.0.2	10.0.0.1
Remote Subnet	192.168.2.0	192.168.1.0
Remote Subnet Mask	255.255.255.0	255.255.255.0

Table 49: GRE Tunnel Configuration Example



Examples of different options for configuration of GRE tunnel can be found in the application note *GRE Tunnel* [7].

3.18 L2TP



L2TP is an unencrypted protocol. L2TP via IPv6 is not supported.

To open the *L2TP Tunnel Configuration* page, click *L2TP* in the *Configuration* section of the main menu. The L2TP tunnel function allows you to create a password-protected connection between two different LAN networks. Enable the *Create L2TP tunnel* checkbox to activate the tunnel.

L2TP Tunnel Configuration

Create L2TP tunnel

Mode ▼
L2TP client

Server IP Address

Client Start IP Address

Client End IP Address

Local IP Address *

Remote IP Address *

Remote Subnet *

Remote Subnet Mask *

MRU 1400 bytes

MTU 1400 bytes

Username

Password 👁

* can be blank

Apply

Figure 70: L2TP Tunnel Configuration Page

Item	Description
Mode	Specifies the L2TP tunnel mode on the router side: <ul style="list-style-type: none"> L2TP server – Specify an IP address range offered by the server. L2TP client – Specify the IP address of the server.
Server IP Address	IP address of the server.
Client Start IP Address	IP address to start with in the address range. The range is offered by the server to the clients.
Client End IP Address	The last IP address in the address range. The range is offered by the server to the clients.
Local IP Address	IP address of the local side of the tunnel.
Remote IP Address	IP address of the remote side of the tunnel.

Continued on next page

Continued from previous page

Item	Description
Remote Subnet	Address of the network behind the remote side of the tunnel.
Remote Subnet Mask	The mask of the network behind the remote side of the tunnel.
MRU	Maximum Receive Unit value. Default value is 1400 bytes.
MTU	Maximum Transmission Unit value. Default value is 1400 bytes.
Username	Username for the L2TP tunnel login.
Password	Password for the L2TP tunnel login. Enter valid characters only.

Table 50: L2TP Tunnel Configuration Items Description

3.18.1 Example of the L2TP Tunnel Configuration

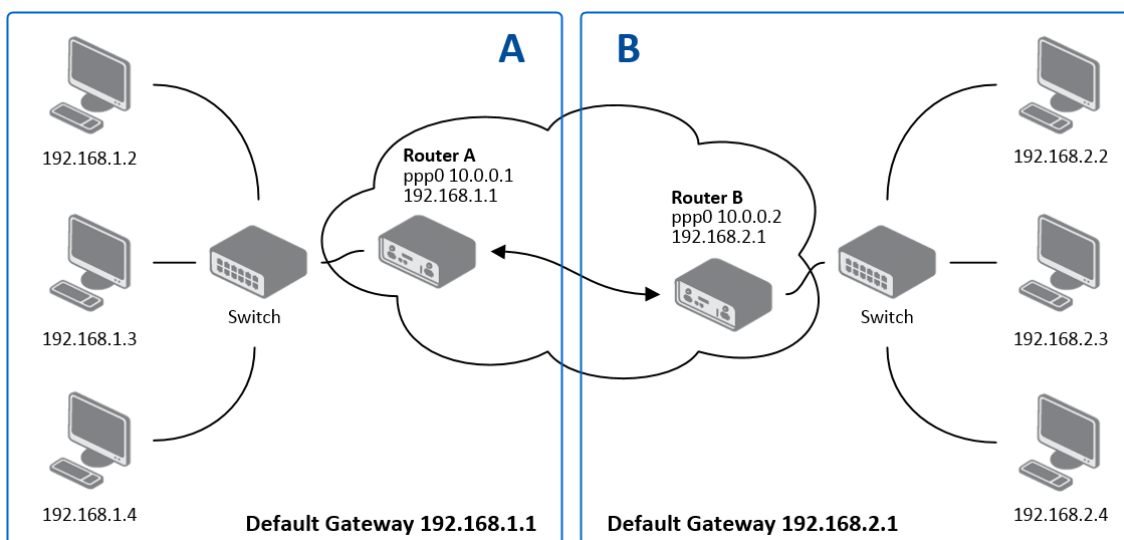

Figure 71: Topology of L2TP Tunnel Configuration Example

Configuration of the L2TP tunnel:

Configuration	A	B
Mode	L2TP Server	L2TP Client
Server IP Address	—	10.0.0.1
Client Start IP Address	192.168.2.5	—
Client End IP Address	192.168.2.254	—
Local IP Address	192.168.1.1	—
Remote IP Address	—	—
Remote Subnet	192.168.2.0	192.168.1.0
Remote Subnet Mask	255.255.255.0	255.255.255.0
Username	username	username
Password	password	password

Table 51: L2TP Tunnel Configuration Example

3.19 PPTP



PPTP is an unencrypted protocol. PPTP via IPv6 is not supported.

Select the *PPTP* item in the menu to configure a PPTP tunnel. PPTP tunnel allows password-protected connections between two LANs. It is similar to L2TP. The tunnels are active after selecting *Create PPTP tunnel*.

PPTP Tunnel Configuration

Create PPTP tunnel

Mode ▼

Server IP Address

Local IP Address

Remote IP Address

Remote Subnet *

Remote Subnet Mask *

MRU bytes

MTU bytes

Username

Password

** can be blank*

Figure 72: PPTP Tunnel Configuration Page

Item	Description
Mode	Specifies the L2TP tunnel mode on the router side: <ul style="list-style-type: none"> • PPTP server – Specify an IP address range offered by the server. • PPTP client – Specify the IP address of the server.
Server IP Address	IP address of the server.
Local IP Address	IP address of the local side of the tunnel.
Remote IP Address	IP address of the remote side of the tunnel.
Remote Subnet	Address of the network behind the remote side of the tunnel.
Remote Subnet Mask	The mask of the network behind the remote side of the tunnel
MRU	Maximum Receive Unit value. Default value is 1460 bytes to avoid fragmented packets.

Continued on next page

Continued from previous page

Item	Description
MTU	Maximum Transmission Unit value. Default value is 1460 bytes to avoid fragmented packets.
Username	Username for the PPTP tunnel login.
Password	Password for the PPTP tunnel login. Enter valid characters only.

Table 52: PPTP Tunnel Configuration Items Description

The changes in settings will apply after pressing the *Apply* button.



The firmware also supports PPTP passthrough, which means that it is possible to create a tunnel through the router.

3.19.1 Example of the PPTP Tunnel Configuration

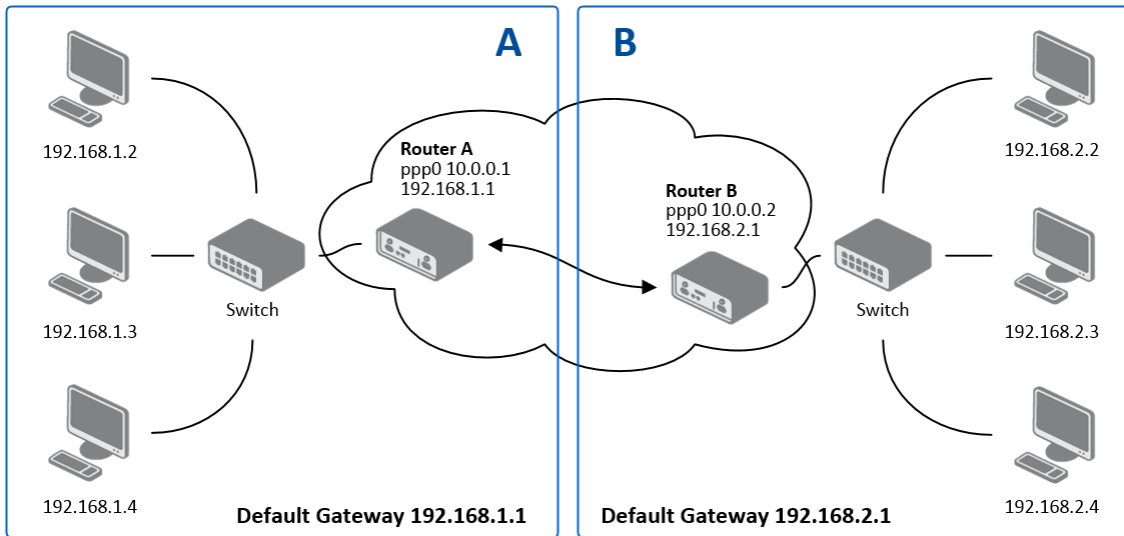

Figure 73: Topology of PPTP Tunnel Configuration Example

Configuration of the PPTP tunnel:

Configuration	A	B
Mode	PPTP Server	PPTP Client
Server IP Address	—	10.0.0.1
Local IP Address	192.168.1.1	—
Remote IP Address	192.168.2.1	—
Remote Subnet	192.168.2.0	192.168.1.0
Remote Subnet Mask	255.255.255.0	255.255.255.0
Username	username	username
Password	password	password

Table 53: PPTP Tunnel Configuration Example

3.20 Services

3.20.1 Authentication

User authentication options can be configured on the *Configuration* → *Authentication* page. Figure 74 shows the configuration for *local user database* mode. Table 54 describes configuration items for *local user database* mode that are common to all other modes as well.

Authentication Configuration	
Two-Factor Authentication	disabled
Mode	local user database
Lock Account After	3 fail(s)
Count Fails For	3600 sec
Unlock After	60 sec
Force Password Complexity	good
Expire Password After *	days
Delay After Fail *	1 sec
Debug	disabled
* can be blank	
Apply	

Figure 74: Common Configuration Items

Item	Description
Two-Factor Authentication	To enable the two-factor authentication service, choose the service type you want to use from <i>Google Authenticator</i> or <i>OATH Toolkit</i> . For more details refer to Chapter 5.2.1 <i>Two-Factor Authentication</i> .
Mode	<ul style="list-style-type: none"> • Local user database – Authenticate against the local user database only. See Chapter 5.1 <i>Manage Users</i>. • RADIUS with fallback – Authenticate against the RADIUS server first, and then against the local database if the RADIUS server is not accessible. • RADIUS only – Authenticate only against the RADIUS server. Note that you will not be able to authenticate to the router if the RADIUS server is not accessible! • TACACS+ with fallback – Authenticate against the TACACS+ server first, and then against the local database if the TACACS+ server is not accessible. • TACACS+ only – Authenticate only against the TACACS+ server. Note that you will not be able to authenticate to the router if the TACACS+ server is not accessible!
Lock Account After	Number of failed login attempts after which the account will be locked.

Continued on the next page

Continued from previous page

Item	Description
Count Fails For	The time window for which unsuccessful login attempts will be counted.
Unlock After	The time after which logging will be unlocked if it was previously locked.
Force Password Complexity	Specify the level of password complexity: <ul style="list-style-type: none"> • very weak – Not secure and not recommended. Requires 6 characters. Time to crack: Seconds to minutes. • weak – Not secure and not recommended. Requires 8 characters from two sets (numbers, letters) [NIST SP 800-63B compliant]. Time to crack: Hours to days. • good – Reasonably secure. Requires 12 characters from three sets (uppercase letters, lowercase letters, and numbers), with a maximum of 3 same characters in sequence [FirstNet compliant]. Time to crack: Months to years. • strong – For the best security level. Requires 16 characters from four sets (uppercase and lowercase letters, digits, and special characters). Time to crack: Centuries.
Expire Password After	Number of days after which the password will expire and the user will be prompted to change it; see Chapter 5.2.3 Expired Password .
Delay After Fail	The time after which the login screen will appear again in case of a previous unsuccessful attempt.
Debug	Enable or disable debugging in the Syslog.

Table 54: Enter Caption

RADIUS Mode



When authenticate against the RADIUS server, user with the same name must exist locally. It can be created manually (see Chapter 5.1 *Manage Users*) or can be created automatically based on data from RADIUS server, if the *Take Over Server Users* option is enabled as described hereunder.

To configure the authentication against a RADIUS server, choose *RADIUS with fallback* or *RADIUS only* as the *PAM mode* and set up all required items, see Figure 75. Table 55 describes all the configuration options for the RADIUS PAM modes.

Authentication Configuration

Two-Factor Authentication disabled ▼

Mode RADIUS only ▼

RADIUS Server(s)

	Server	Port *	Secret	Timeout *	
<input type="checkbox"/>	<input type="text"/>	<input type="text"/>	<input type="text"/>	<input type="text"/>	sec
<input type="checkbox"/>	<input type="text"/>	<input type="text"/>	<input type="text"/>	<input type="text"/>	sec

Take Over Server Users disabled ▼

Default User Role admin ▼

Delay After Fail * 1 sec

Debug disabled ▼

* can be blank

Figure 75: Configuration of RADIUS

Item	Description
Server	Address of the RADIUS server. Up to two servers can be configured.
Port	Port of the RADIUS server.
Secret	The secret For authentication to the RADIUS server.
Timeout	Timeout for authentication to the RADIUS server.
Take Over Server Users	If enabled, a new user account is created during the login, in case the RADIUS authentication is successful and appropriate local account does not exist. New accounts are created without the password. An existing user account with a password is never modified by this feature.
Default User Role	Choose the user role (<i>Admin</i> or <i>User</i>). This role corresponds with router’s user roles, see Chapter 5.1 <i>Manage Users</i> . Selected role will be used for a user in case the option <i>Take Over Server Users</i> is enabled and if the user’s <i>Service-Type</i> set on the RADIUS server is missing or is not set up to <i>NAS-Prompt-User</i> or <i>Administrative-User</i> . When <i>Service-Type</i> is set to <i>NAS-Prompt-User</i> , the <i>User</i> role will be used. When <i>Service-Type</i> is set to <i>Administrative-User</i> , the <i>Admin</i> role is used.

Table 55: Configuration of RADIUS

TACACS+ Mode



When authenticate against the TACACS+ server, user with the same name must exist locally. It can be created manually (see Chapter 5.1 *Manage Users*) or can be created automatically based on data from TACACS+ server, if the *Take Over Server Users* option is enabled as described hereunder.

To configure the authentication against a TACACS+ server, choose *TACACS+ with fallback* or *TACACS+ only* as the *PAM mode* and set up all required items, see Figure 76. Table 56 describes all the configuration options for the TACACS PAM modes.

Authentication Configuration

Two-Factor Authentication	disabled	
Mode	TACACS+ only	
TACACS+ Server(s)		
Authentication Type	ASCII	
Timeout *	<input type="text"/> sec	
	Server	Port *
<input type="checkbox"/>	<input type="text"/>	<input type="text"/>
<input type="checkbox"/>	<input type="text"/>	<input type="text"/>
Take Over Server Users	disabled	
Default User Role	admin	
Delay After Fail *	<input type="text"/> sec	
Debug	disabled	
<small>* can be blank</small>		
<input type="button" value="Apply"/>		

Figure 76: Configuration of TACACS+

Item	Description
Authentication Type	Choose ASCII, PAP or CHAP as authentication type. To configure the two-factor authentication for a user, see Chapter 5.2.1 <i>Two-Factor Authentication</i> .
Timeout	Timeout for authentication to the TACACS+ server.
Server	Address of the TACACS+ server. Up to two servers can be configured.
Port	Port of the TACACS+ server.
Secret	The secret For authentication to the TACACS+ server.
Take Over Server Users	If enabled, a new user account is created during the login, in case the TACACS+ authentication is successful and appropriate local account does not exist. New accounts are created without the password. An existing user account with a password is never modified by this feature.
Default User Role	Choose the user role (<i>Admin</i> or <i>User</i>). This role corresponds with router’s user roles, see Chapter 5.1 <i>Manage Users</i> . Selected role will be used for a new user when <i>Take Over Server Users</i> is used.

Table 56: Configuration of TACACS+

3.20.2 DynDNS

The DynDNS function allows you to access the router remotely using an easy-to-remember custom host-name. This DynDNS client monitors the router’s IP address and updates it whenever a change occurs. For DynDNS to function, a public IP address, either static or dynamic, is required, along with an active Remote Access service account on a Dynamic DNS server. Register the custom (third-level) domain and account information specified in the configuration form.

Other services can also be used, see the table below under the *Server* item. To open the *DynDNS Configuration* page, click *DynDNS* in the main menu.

Item	Description
Hostname	The third-level domain registered on a Dynamic DNS server.
Username	Username for logging into the DynDNS server.
Password	Password for logging into the DynDNS server. Enter only valid characters (see Chapter 1.2.1).
IP Mode	Specifies the IP protocol version: <ul style="list-style-type: none"> • IPv4 – Only the IPv4 protocol is used (default). • IPv6 – Only the IPv6 protocol is used. • IPv4/IPv6 – Dual stack mode (IPv4 and IPv6) is enabled.
Server	Specifies a DynDNS service. Some available free services include: www.freedns.afraid.org , www.duckdns.org , www.noip.com . Enter the update server’s service information in this field. If left blank, the default server <code>members.dyndns.org</code> will be used.

Table 57: DynDNS Configuration Items Description

Example of a DynDNS client configuration with the domain *company.dyndns.org*:

Figure 77: DynDNS Configuration Example



To access the router’s configuration remotely, ensure that this option is enabled in the NAT configuration (bottom part of the form). See Chapter 3.13 NAT.

3.20.3 FTP

FTP protocol (File Transfer Protocol) can be used to transfer files between the router and another device on the computer network. Configuration form of TP server can be done in *FTP* configuration page under *Services* menu item.

Item	Description
Enable FTP service	Enabling of FTP server.
Maximum Sessions	Indicates how many concurrent connections shall the FTP server accept. Once the maximum is reached, additional connections will be rejected until some of the existing connections are terminated. The range is from 1 to 500.
Session Timeout	Is used to close inactive sessions. The server will terminate a FTP session after it has not been used for the given amount of seconds. The range is from 60 to 7200.

Table 58: FTP Configuration Items Description

FTP Configuration

Enable FTP service

Maximum Sessions

Session Timeout sec

Figure 78: Configuration of FTP server

3.20.4 HTTP

The HTTP protocol (Hypertext Transfer Protocol) is used to exchange hypertext documents in HTML format. It enables access to the router's web server for user configuration. However, it is recommended to use the HTTPS protocol, which encrypts data for secure communication.

The *HTTP* configuration page, found under the *Services* menu, allows for configuring both HTTP and HTTPS services. By default, HTTP is disabled, and HTTPS is preferred. For this default setting, any HTTP request is automatically redirected to HTTPS.

Item	Description
Enable HTTP service	Enables the HTTP service.
Enable HTTPS service	Enables the HTTPS service.
Minimum TLS Version	Specifies the minimum supported TLS version. For better security, choose the highest version of the TLS protocol unless compatibility with older web browsers is required.
Session Timeout	Defines the inactivity timeout period after which the session is closed.
Login Banner	Displays the specified text on the login page above the credentials fields.
Keep the current certificate	Retains the current certificate in the router.
Generate a new certificate	Generates a new self-signed certificate for the router.
Upload a new certificate	Uploads a custom PEM certificate, which can be signed by a Certificate Authority.
Certificate	Specifies the file containing the PEM certificate to upload. Note: The file may contain multiple certificates organized in a certificate chain.
Private Key	Specifies the file containing the private key for the certificate.

Table 59: HTTP Configuration Items Description

HTTP Configuration

Enable HTTP service

Enable HTTPS service

Minimum TLS Version TLS 1.2 ▼

Session Timeout 6000 sec

Login Banner

Keep the current certificate

Generate a new certificate

Upload a new certificate

Certificate Choose File No file chosen

Private Key Choose File No file chosen

Apply

Figure 79: HTTP Configuration Page

3.20.5 NTP

The NTP (Network Time Protocol) configuration form allows you to configure the NTP client or NTP server. To open the *NTP* configuration page, click *NTP* in the *Configuration* section of the main menu.



Using the router as an NTP server without synchronization to another reliable NTP server is not recommended, as there is a risk of synchronizing incorrect time with other devices on the network.



When running the NTP service for the first time, there is an approximate 15-minute delay before it begins working in continuous mode due to Hardware Clock adjustment. The message `TIME_ERROR: Clock Unsynchronized` in the syslog is normal during NTP startup. The time will be synchronized shortly thereafter.

Item	Description
Enable local NTP server	Enables a local NTP server running on the device.
Synchronize clock with remote NTP server	Enables the NTP client for clock synchronization with a remote NTP server.
Primary NTP Server	IP address or domain name of the primary NTP server.
Secondary NTP Server	IP address or domain name of the secondary NTP server.
Tertiary NTP Server	IP address or domain name of the tertiary NTP server.
Maximal Pooling Interval	Select the maximum pooling interval for synchronization.
Enable fast initial synchronization	Allows for quick and immediate time synchronization, even in cases of significant differences between the system time and the time on the NTP server. This function is useful when the time difference between the system and the NTP server is large and needs to be corrected quickly.
Timezone	Specifies the time zone where the router is installed.
Daylight Saving Time	Activates or deactivates the DST shift.

Table 60: NTP Configuration Items Description

NTP Configuration

Enable local NTP server

Synchronize clock with remote NTP server

Primary NTP Server

Secondary NTP Server

Tertiary NTP Server

Maximal Polling Interval

Enable fast initial synchronization

Timezone

Daylight Saving Time

Figure 80: NTP Configuration Page

3.20.6 SNMP

The *SNMP* page allows you to configure the SNMP v1/v2 or v3 agent, which transmits information about the router and its expansion ports (if applicable) to a management station. To access the *SNMP* page, click *SNMP* in the *Configuration* section of the main menu.

SNMP (Simple Network Management Protocol) provides status information about network elements such as routers or endpoint computers. In SNMP v3, communication is secured through encryption. To enable the SNMP service, select the *Enable the SNMP agent* checkbox. Sending SNMP traps to IPv6 addresses is supported.

Item	Description
Name	Router designation.
Location	Physical location where the router is installed.
Contact	Contact details of the person responsible for managing the router.
Custom	Field for entering additional specific information based on user requirements.

Table 61: SNMP Agent Configuration

To enable SNMPv1/v2, select the *Enable SNMPv1/v2 access* checkbox and specify a password for access to the *Community* SNMP agent. The default setting is *public*.

You can define a separate password for the *Read* community (read-only) and the *Write* community (read and write) in SNMPv1/v2. Additionally, SNMPv3 allows you to configure up to two SNMP users: one with read-only access (*Read*) and another with read and write access (*Write*).

Each user's configuration is independent, and the router applies these settings exclusively for SNMP access.

To enable SNMPv3, select the *Enable SNMPv3 access* checkbox and specify the following parameters:

Item	Description
Username	Name of the SNMPv3 user.
Authentication	Encryption algorithm used in the Authentication Protocol to verify user identity.
Authentication Password	Password used to generate the authentication key. Note: Enter valid characters only, see Chapter 1.2.1.
Privacy	Encryption algorithm used in the Privacy Protocol to ensure data confidentiality.
Privacy Password	Password used for encryption in the Privacy Protocol. Note: Enter valid characters only, see Chapter 1.2.1.

Table 62: SNMPv3 Configuration

Activating the *Enable I/O extension* function allows you to monitor the binary I/O inputs on the router.



Enabling the *Enable M-BUS extension* option and configuring the *Baudrate*, *Parity*, and *Stop Bits* settings allows you to monitor the status of meters connected via the MBUS interface. While the MBUS expansion port is not currently supported, it is possible to use an external RS232/MBUS converter.

Enabling the *Enable reporting to supervisory system* option and specifying the *IP Address* and *Period* allows the router to send statistical data to the R-SeeNet monitoring system.

Item	Description
IP Address	Specifies the IPv4 or IPv6 address.
Period	Interval for sending statistical information (in minutes).

Table 63: SNMP Configuration (R-SeeNet)

Each monitored value is uniquely identified using a numerical identifier called an *OID* (Object Identifier). This identifier consists of a sequence of numbers separated by dots, forming a hierarchical tree structure. Each OID derives from its parent identifier, appending an additional number to indicate its position in the hierarchy. The figure below illustrates the fundamental tree structure used for creating OIDs.

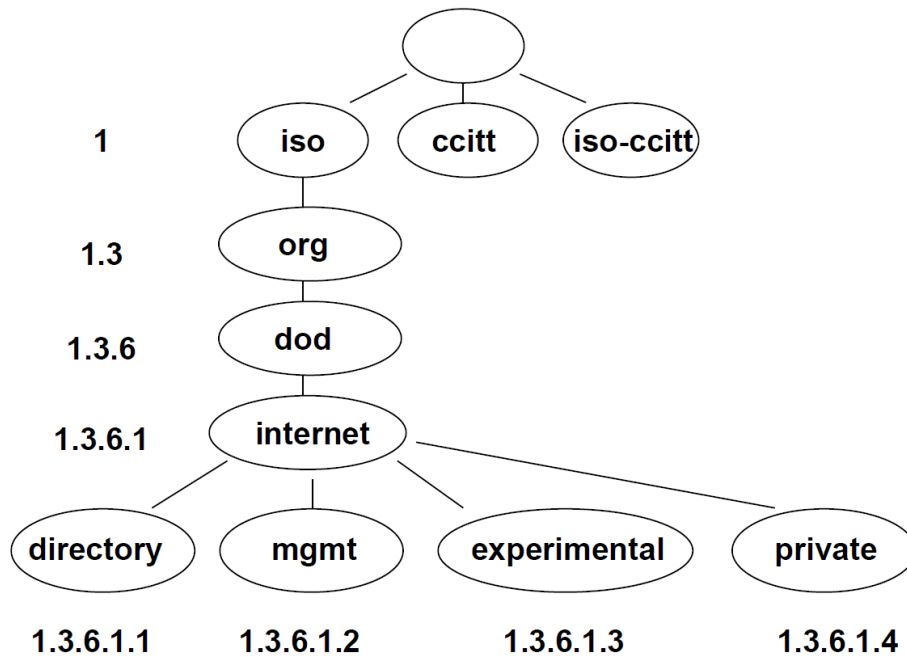

Figure 81: OID Basic Structure

The SNMP values specific to Advantech routers form a hierarchical tree starting at OID .1.3.6.1.4.1.30140. This OID can be interpreted as follows:

iso.org.dod.internet.private.enterprises.conel

This means that the router provides, for example, information about the internal temperature (OID 1.3.6.1.4.1.30140.3.3) or power voltage (OID 1.3.6.1.4.1.30140.3.4).

For binary inputs and outputs, the following OID range is used:

OID	Description
.1.3.6.1.4.1.30140.2.3.1.0	Binary input BIN0 (values: 0,1)
.1.3.6.1.4.1.30140.2.3.2.0	Binary output OUT0 (values: 0,1)
.1.3.6.1.4.1.30140.2.3.3.0	Binary input BIN1 (values: 0,1)

Table 64: Object Identifiers for Binary Inputs and Outputs



The list of available and supported OIDs, along with other details, can be found in the application note *SNMP Object Identifiers* [11].

The following figure shows an example of SNMP configuration.

SNMP Configuration		
<input checked="" type="checkbox"/> Enable SNMP agent		
Name *	<input type="text" value="Company"/>	
Location *	<input type="text" value="City, Street ##"/>	
Contact *	<input type="text" value="Jack Roghul +420 732 123"/>	
Custom *	<input type="text"/>	
<i>(Configuration via SNMP is not possible.)</i>		
<input checked="" type="checkbox"/> Enable SNMPv1/v2 access		
	Read	Write
Community	<input type="text" value="public"/>	<input type="text" value="private"/>
<input type="checkbox"/> Enable SNMPv3 access		
	Read	Write
Username	<input type="text"/>	<input type="text"/>
Authentication	<input type="text" value="MD5"/>	<input type="text" value="MD5"/>
Authentication Password	<input type="text"/>	<input type="text"/>
Privacy	<input type="text" value="DES"/>	<input type="text" value="DES"/>
Privacy Password	<input type="text"/>	<input type="text"/>
<input type="checkbox"/> Enable I/O extension		
<input type="checkbox"/> Enable M-BUS extension		
Baudrate	<input type="text" value="300"/>	
Parity	<input type="text" value="even"/>	
Stop Bits	<input type="text" value="1"/>	
<input type="checkbox"/> Enable reporting to supervisory system		
IP Address	<input type="text"/>	
Period	<input type="text"/>	min
* can be blank		
<input type="button" value="Apply"/>		

Figure 82: SNMP Configuration Example

The next figure illustrates SNMP browsing in the MIB Browser.

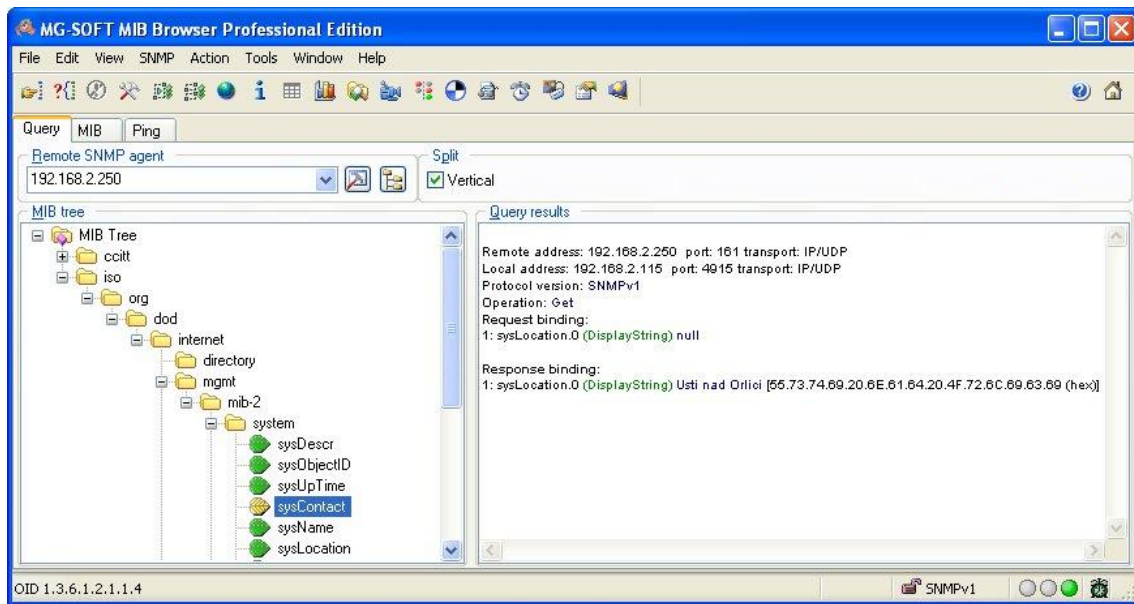

Figure 83: MIB Browser Example

To access a specific device, enter the IP address of the SNMP agent (the router) in the *Remote SNMP Agent* field. The dialog displays the internal variables in the MIB tree after entering the IP address. Additionally, you can check the status of internal variables by entering their corresponding OID.

The path to the SNMP objects is:

iso → *org* → *dod* → *internet* → *private* → *enterprises* → *Conel* → *protocols*

The path to router-specific information is:

iso → *org* → *dod* → *internet* → *mgmt* → *mib-2* → *system*

3.20.7 SMTP

You use the *SMTP* form to configure the Simple Mail Transfer Protocol client (SMTP) for sending emails.

Item	Description
SMTP Server Address	IP or domain address of the mail server.
SMTP Port	Port the SMTP server is listening on.
Secure Method	none, SSL/TLS, or STARTTLS. The secure method must be supported by the SMTP server.
Username	Name for the email account.
Password	Password for the email account. Enter valid characters only.
Own Email Address	Address of the sender.

Table 65: SMTP Client Configuration



The mobile service provider may block other SMTP servers, so you might only be able to use the SMTP server of the service provider.

SMTP Configuration

SMTP Server Address	<input type="text" value="smtp.domain.com"/>
SMTP Port	<input type="text" value="465"/>
Secure Method	<input style="border-bottom: 1px solid #ccc;" type="text" value="SSL/TLS"/> ▼
Username	<input type="text" value="username"/>
Password	<input type="password" value="....."/>
Own Email Address	<input type="text" value="name@domain.com"/>
<input type="button" value="Apply"/>	

Figure 84: SMTP Client Configuration Example

You can send emails from the startup script. The *Startup Script* dialog is located in *Scripts* in the *Configuration* section of the main menu.

The router also allows you to send emails using an SSH connection. Use the `email` command, see *Command Line Interface* [1] Application Note for details.

3.20.8 SMS

Open the *SMS Configuration* page, click *SMS* in the *Configuration* section of the main menu. The router can automatically send SMS messages to a cell phone or SMS message server when certain events occur. The form allows you to select which events generate an SMS message.

SMS Configuration

Send SMS on power up

Send SMS on connect to mobile network

Send SMS on disconnect from mobile network

Send SMS when datalimit is exceeded

Send SMS when binary input on I/O port (BIN0) is active

Add timestamp to SMS

Phone Number 1

Phone Number 2

Phone Number 3

Unit ID *

BIN0 - SMS *

Enable remote control via SMS

Phone Number 1

Phone Number 2

Phone Number 3

Enable AT-SMS protocol over TCP

TCP Port

** can be blank*

Figure 85: SMS Configuration

Item	Description
Send SMS on power up	Activates/deactivates the sending of an SMS message automatically on power up.
Send SMS on connect to mobile network	Activates/deactivates the sending of an SMS message automatically when the router is connected to a mobile network.
Send SMS on disconnect to mobile network	Activates/deactivates the sending of an SMS message automatically when the router is disconnection from a mobile network.

Continued on next page

Continued from previous page

Item	Description
Send SMS when datalimit exceeded	Activates/deactivates the sending of an SMS message automatically when the data limit exceeded.
Send SMS when binary input on I/O port (BIN0) is active	Automatic sending SMS message after binary input on I/O port (BIN0) is active. Text of message is intended parameter BIN0.
Add timestamp to SMS	Activates/deactivates the adding a time stamp to the SMS messages. This time stamp has a fixed format YYYY-MM-DD hh:mm:ss.
Phone Number 1	Specifies the phone number to which the router sends the generated SMS.
Phone Number 2	Specifies the phone number to which the router sends the generated SMS.
Phone Number 3	Specifies the phone number to which the router sends the generated SMS.
Unit ID	The name of the router. The router sends the name in the SMS.
BIN0 – SMS	Text of the SMS message when the first binary input is activated.
BIN1 – SMS	Text of the SMS message when the second binary input is activated.

Table 66: SMS Configuration

Remote Control via SMS

After you enter a phone number in the *Phone Number 1* field, the router allows you to configure the control of the device using an SMS message. You can configure up to three numbers for incoming SMS messages. To enable the function, mark the *Enable remote control via SMS* check box. The default setting of the remote control function is active.

Item	Description
Phone Number 1	Specifies the first phone number allowed to access the router using an SMS.
Phone Number 2	Specifies the second phone number allowed to access the router using an SMS.
Phone Number 3	Specifies the third phone number allowed to access the router using an SMS.
TCP Port	TCP port on which will be allowed to send/receive SMS messages.

Table 67: Control via SMS and AT-SMS over TCP



If you enter one or more phone numbers, then you can control the router using SMS messages sent only from the specified phone numbers.
If you enter the wild card character *, then you can control the router using SMS messages sent from any phone number.

Most of the control SMS messages do not change the router configuration. For example, if the router is changed to the off line mode using an SMS message, the router remains in this mode, but it will return back to the on-line mode after reboot. The only exception is *set profile* command that changes the configuration permanently, see the table below.

To control the router using an SMS, send only message text containing the control command. You can send control SMS messages in the following form:

SMS	Description
go online sim 1	The router changes to SIM1
go online sim 2	The router changes to SIM2
go online sim 3	The router changes to SIM3
go online sim 4	The router changes to SIM4
go online	Changes the router to the online mode
go offline	Changes the router to the off line mode
set out0=0	Sets the binary output to 0
set out0=1	Sets the binary output to 1
set profile std	Sets the standard profile. This change is permanent.
set profile alt1	Sets the alternative profile 1. This change is permanent.
set profile alt2	Sets the alternative profile 2. This change is permanent.
set profile alt3	Sets the alternative profile 3. This change is permanent.
reboot	The router reboots
get ip	The router responds with the IP address of the SIM card

Table 68: Control SMS



Note: Every received control SMS is processed and then **deleted** from the router! This may cause a confusion when you want to use AT-SMS protocol for reading received SMS (see section below).



Advanced SMS control: If there is unknown command in received SMS and remote control via SMS is enabled, the script located in `"/var/scripts/sms"` is run before the SMS is deleted. It is possible to define your own additional SMS commands using this script. Maximum of 7 words can be used in such SMS. Since the script file is located in RAM of the router, it is possible to add creation of such file to Startup Script. See example in *Command Line Interface Application Note [1]*.

AT-SMS Protocol



AT-SMS protocol is a private set of AT commands supported by the routers. It can be used to access the cellular module in the router directly via commonly used AT commands, work with short messages (send SMS) and cellular module state information and settings.

Setting the parameters in the *Enable AT-SMS protocol over TCP* frame, you can enable the router to use AT-SMS protocol on a TCP port. This function requires you to specify a TCP port number.

Item	Description
TCP Port	TCP port on which will be allowed to send/receive SMS messages.

Table 69: Sending/receiving of SMS on TCP port specified

If you establish a connection to the router through a serial interface or interface using the TCP protocol, then you can use AT commands to manage SMS messages.

Only the commands supported by the routers are listed in the following table. For other AT commands the OK response is always sent. There is no support for treatment of complex AT commands, so in such a case the router sends ERROR response.

AT Command	Description
AT+CGMI	Returns the manufacturer specific identity
AT+CGMM	Returns the manufacturer specific model identity
AT+CGMR	Returns the manufacturer specific model revision identity
AT+CGPADDR	Displays the IP address of the Mobile WAN interface
AT+CGSN	Returns the product serial number
AT+CIMI	Returns the International Mobile Subscriber Identity number (IMSI)
AT+CMGD	Deletes a message from the location
AT+CMGF	Sets the presentation format of short messages
AT+CMGL	Lists messages of a certain status from a message storage area
AT+CMGR	Reads a message from a message storage area
AT+CMGS	Sends a short message from the device to entered tel. number
AT+CMGW	Writes a short message to SIM storage
AT+CMSS	Sends a message from SIM storage location value
AT+CNUM	Returns the phone number, if available (stored on SIM card)
AT+COPS?	Identifies the available mobile networks
AT+CPIN	Is used to find out the SIM card state and enter a PIN code
AT+CPMS	Selects SMS memory storage types, to be used for short message operations
AT+CREG	Displays network registration status
AT+CSCA	Sets the short message service centre (SMSC) number
AT+CSCS	Selects the character set
AT+CSQ	Returns the signal strength of the registered network
AT+GMI	Returns the manufacturer specific identity
AT+GMM	Returns the manufacturer specific model identity
AT+GMR	Returns the manufacturer specific model revision identity
AT+GSN	Returns the product serial number
ATE	Determines whether or not the device echoes characters
ATI	Transmits the manufacturer specific information about the device

Table 70: List of AT Commands



A detailed description and examples of these AT commands can be found in the application note *AT commands* [12].

Sending SMS from Router

There are more ways how to send your own SMS from the router:

- Using AT-SMS protocol described above – if you establish a connection to the router through a serial interface or interface using the TCP protocol, then you can use AT commands to manage SMS messages. See application note *AT Commands (AT-SMS)* [12].
- Using HTTP POST method for a remote execution, calling CGI scripts in the router. See *Command Line Interface Application Note* [1] for more details and example.
- From Web interface of the router, in *Administration* section, *Send SMS* item, see 5.8 Chapter.
- Using `gsmSMS` command e.g. in terminal when connected to the router via SSH, see *Command Line Interface Application Note* [1].

Examples of SMS Configuration

Example 1 Sending SMS Configuration

After powering up the router, the phone with the number entered in the dialog receives an SMS in the following form:

Router (Unit ID) has been powered up. Signal strength -xx dBm.

After connecting to mobile network, the phone with the number entered in the dialog receives an SMS in the following form:

Router (Unit ID) has established connection to mobile network. IP address xxx.xxx.xxx.xxx

After disconnecting from the mobile network, the phone with the number entered in the dialog receives an SMS in the following form:

Router (Unit ID) has lost connection to mobile network. IP address xxx.xxx.xxx.xxx

SMS Configuration

- Send SMS on power up
- Send SMS on connect to mobile network
- Send SMS on disconnect from mobile network
- Send SMS when datalimit is exceeded
- Send SMS when binary input on I/O port (BIN0) is active
- Add timestamp to SMS

Phone Number 1:

Phone Number 2:

Phone Number 3:

Unit ID *:

BIN0 - SMS *:

Enable remote control via SMS

Phone Number 1:

Phone Number 2:

Phone Number 3:

Enable AT-SMS protocol over TCP

TCP Port:

* can be blank

Figure 86: SMS Configuration for Example 1

Example 2 Control the Router Sending SMS from any Phone Number

SMS Configuration	
<input type="checkbox"/>	Send SMS on power up
<input type="checkbox"/>	Send SMS on connect to mobile network
<input type="checkbox"/>	Send SMS on disconnect from mobile network
<input type="checkbox"/>	Send SMS when datalimit is exceeded
<input type="checkbox"/>	Send SMS when binary input on I/O port (BIN0) is active
<input type="checkbox"/>	Add timestamp to SMS
Phone Number 1	<input type="text"/>
Phone Number 2	<input type="text"/>
Phone Number 3	<input type="text"/>
Unit ID *	<input type="text"/>
BIN0 - SMS *	<input type="text"/>
<input checked="" type="checkbox"/>	Enable remote control via SMS
Phone Number 1	<input type="text" value="*"/>
Phone Number 2	<input type="text"/>
Phone Number 3	<input type="text"/>
<input type="checkbox"/>	Enable AT-SMS protocol over TCP
TCP Port	<input type="text"/>
* can be blank	
<input type="button" value="Apply"/>	

Figure 87: SMS Configuration for Example 2

Example 3 Control the Router Sending SMS from Two Phone Numbers

SMS Configuration	
<input type="checkbox"/>	Send SMS on power up
<input type="checkbox"/>	Send SMS on connect to mobile network
<input type="checkbox"/>	Send SMS on disconnect from mobile network
<input type="checkbox"/>	Send SMS when datalimit is exceeded
<input type="checkbox"/>	Send SMS when binary input on I/O port (BIN0) is active
<input type="checkbox"/>	Add timestamp to SMS
Phone Number 1	<input type="text"/>
Phone Number 2	<input type="text"/>
Phone Number 3	<input type="text"/>
Unit ID *	<input type="text"/>
BIN0 - SMS *	<input type="text"/>
<input checked="" type="checkbox"/>	Enable remote control via SMS
Phone Number 1	<input type="text" value="728123456"/>
Phone Number 2	<input type="text" value="766254864"/>
Phone Number 3	<input type="text"/>
<input type="checkbox"/>	Enable AT-SMS protocol over TCP
TCP Port	<input type="text"/>
* can be blank	
<input type="button" value="Apply"/>	

Figure 88: SMS Configuration for Example 3

3.20.9 SSH

SSH protocol (Secure Shell) allows to carry out a secure remote login to the router. Configuration form of SSH service can be done in *SSH* configuration page under *Services* menu item. By ticking *Enable SSH service* item the SSH server on the router is enabled.

Item	Description
Enable SSH service	Enabling of SSH service.
Port	Listening port.
Session Timeout	Inactivity timeout when the session is closed. The maximum allowed value may vary based on security requirements for the specific model.
Login Banner	The text specified in this field will be displayed in the console during the SSH login just after the login name entry.
Keep the current SSH key	Choose to keep current key.
Generate a new SSH key	Choose to generate new key.
Key Type	Choose the key type to be generated. The minimum allowed value may vary based on security requirements for the specific model. There are two types of keys: the RSA (Rivest-Shamir-Adleman) key and the ED25519 key. The ED25519 key is based on elliptic curve cryptography and is considered more secure than RSA.

Table 71: SSH Configuration Items Description

SSH Configuration

Enable SSH service

Port

Session Timeout sec

Login Banner

Keep the current SSH key
 Generate a new SSH key

Key Type

Figure 89: SSH Configuration Page

3.20.10 Syslog

Configuration of the system log, known as *syslog*, is accessible from this configuration page.

To view this log, navigate to the router’s GUI via *Status* → *System Log*. Remember, you can enable auto-refreshing of this page by clicking the *refresh* button in the top-right corner. You can also access the syslog through the console with the `show log` command.

Figure 90: Syslog Configuration Page

Item	Description
Log Size Limit	Limits the maximum log size by the specified number of rows. The default size is 1000 KiB.
Log Persistence	Specifies whether the syslog will persist on the device after a reboot.

Continued on the next page

Continued from previous page

Item	Description
Minimum Severity	Defines the minimum log severity level, ranging from <i>Emergency</i> to <i>Debug</i> . The <i>Debug</i> level offers detailed logs useful for troubleshooting but should be used only when necessary. Note: Some configuration pages (e.g., WiFi, IPsec, Authentication) or Router Apps may include separate logging level settings.
Mark Message Period	Defines the time interval during which the <code>-- MARK --</code> string will be printed in the syslog, acting as a keepalive message.
Read Kernel Log	Enables retrieval of new log messages from <code>/dev/kmsg</code> . Check this option to forward kernel messages, such as device mounting notifications or firewall LOG target messages. Upon service (re)start, all existing kernel log entries will be sent to the remote server, potentially resulting in duplicate messages. Afterward, only new messages will be forwarded.
Enable Forwarding	Enables forwarding of syslog messages to a specified host capable of processing them.
Protocol	Selects the protocol used for forwarding: <ul style="list-style-type: none"> • UDP • TCP • SSL/TLS
Remote Host	Specifies the hostname or IP address of the remote host for real-time syslog forwarding.
Remote Port	Defines the port used for forwarding.
Device ID	A unique identifier for remote logging. If left blank, the default identifier <i>Router</i> is used.
Authentication	Configures the authentication method for the syslog server when using SSL/TLS. Options include: <ul style="list-style-type: none"> • None (encryption only) – Disables authentication for the receiver; communication remains encrypted. • Certificate fingerprint – Validates the server certificate fingerprint against Acceptable Peers. • Certificate validity – Accepts any server with a valid certificate signed by the specified CA. • Certified peer name – Checks the validity of the certificate and verifies the certified DNS names in the <i>subjectAltName</i> extension or the Common Name against Acceptable Peers. <p>Note: The server may apply its own sender authentication settings, independent of this configuration.</p>
Acceptable Peers	Specifies the accepted certificate fingerprint (SHA1) or DNS/Common Name of the remote peer. Wildcards are allowed, e.g., <code>*.example.net</code> . Required if Authentication is set to Certificate fingerprint or Certified peer name.

Continued on the next page

Continued from previous page

Item	Description
CA Certificates	Provides the full certificate chain (CA certificates in PEM format) for validating remote certificates. Not required if Authentication is set to None.
Local Certificate	Specifies a certificate in PEM format, which must be authorized for TLS client authentication.
Local Private Key	Configures the local private key and certificate. This is optional if the server does not require transport sender authentication.

Table 72: Syslog Configuration Items Description

3.20.11 Telnet

Telnet is a protocol used to provide a bidirectional interactive text-oriented communication facility with the router. Configuration form of Telnet service can be done in *Telnet* configuration page under *Services* menu item.

Item	Description
Enable Telnet service	Enabling of Telnet service.
Maximum Sessions	Is used to close inactive sessions. The server will terminate a Telnet session after it has not been used for the given amount of seconds. The range is from 1 to 500.

Table 73: Telnet Configuration Items Description

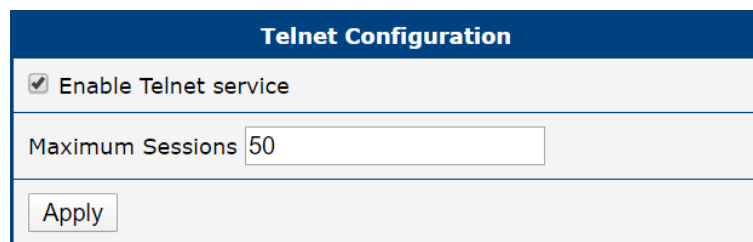

The screenshot shows a configuration window titled "Telnet Configuration". It contains a checked checkbox labeled "Enable Telnet service". Below this is a text input field labeled "Maximum Sessions" with the value "50" entered. At the bottom of the window is an "Apply" button.

Figure 91: Telnet Configuration Page

3.21 USB Port

You can use a USB to RS232 converter to send data out of the serial port from the Ethernet network in the same manner as the RS232 expansion port function. To specify the values for the USB port parameters, click *USB Port* in the *Configuration* section of the main menu. The following tables describe the parameters available in the configuration form. IPv6 TCP/UDP client/server are supported.

The USB port can be disabled by clearing the *Enable external USB port* checkbox. Ensure that all filesystems attached to storage are unmounted before disabling the USB port.

Item	Description
Baudrate	Applied communication speed.
Data Bits	Number of data bits.
Parity	Control parity bit: <ul style="list-style-type: none"> • none – data will be sent without parity. • even – data will be sent with even parity. • odd – data will be sent with odd parity.
Stop Bits	Number of stop bit.
Flow Control	Set the flow control to none or hardware .
Split Timeout	Time to rupture reports. If the gap between two characters exceeds the parameter in milliseconds, any buffered characters will be sent over the Ethernet port.
Protocol	Communication protocol: <ul style="list-style-type: none"> • TCP – communication using a linked protocol TCP. • UDP – communication using a unlinked protocol UDP.
Mode	Mode of connection: <ul style="list-style-type: none"> • TCP server – The router will listen for incoming TCP connection requests. • TCP client – The router will connect to a TCP server on the specified IP address and TCP port.
Server Address	When set to <i>TCP client</i> above, it is necessary to enter the <i>Server address</i> and <i>TCP port</i> . IPv4 and IPv6 addresses are allowed.
TCP Port	TCP/UDP port used for communications. The router uses the value for both the server and client modes.
Inactivity Timeout	Time period after which the TCP/UDP connection is interrupted in case of inactivity.

Table 74: USB Port Configuration 1

If you mark the *Reject new connections* check box, then the router rejects any other connection attempt. This means that the router no longer supports multiple connections.

If you mark the *Check TCP connection* check box, the router verifies the TCP connection.

Item	Description
Keepalive Time	Time after which the router verifies the connection.
Keepalive Interval	Length of time that the router waits on an answer.
Keepalive Probes	Number of tests that the router performs.

Table 75: USB Port Configuration 2

The router supports the following USB/RS232 converters:

- FTDI
- Prolific PL2303
- Silicon Laboratories CP210×

USB Port Configuration

Enable USB serial converter access over TCP/UDP

Baudrate:

Data Bits:

Parity:

Stop Bits:

Flow Control:

Split Timeout: msec

Protocol:

Mode:

Server Address:

TCP Port:

Inactivity Timeout *: sec

Reject new connections

Check TCP connection

Keepalive Time: sec

Keepalive Interval: sec

Keepalive Probes:

Use CD as indicator of TCP connection

Use DTR as control of TCP connection

Figure 92: USB configuration

3.21.1 Examples of USB Port Configuration

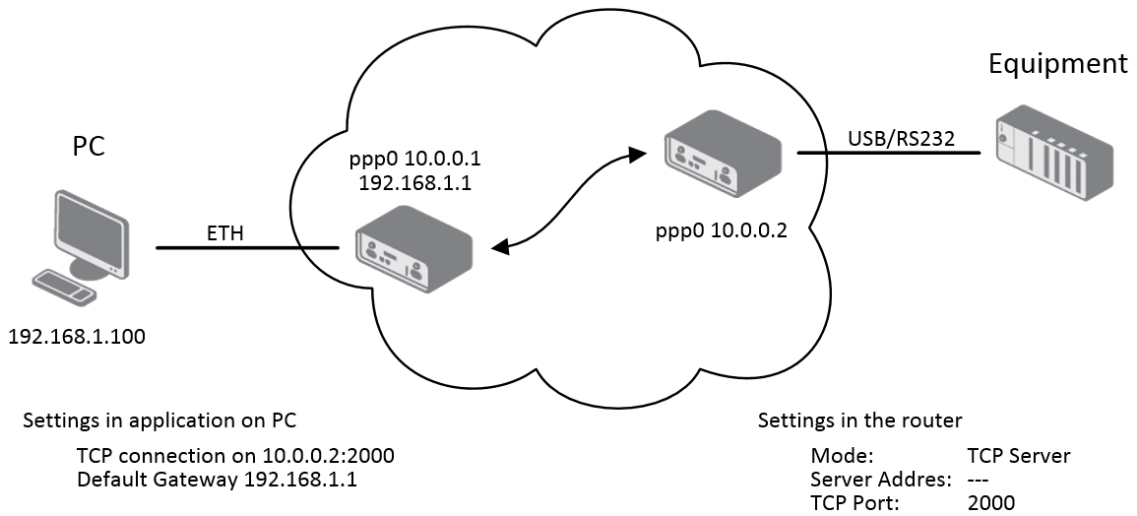

Figure 93: Example 1 – USB port configuration

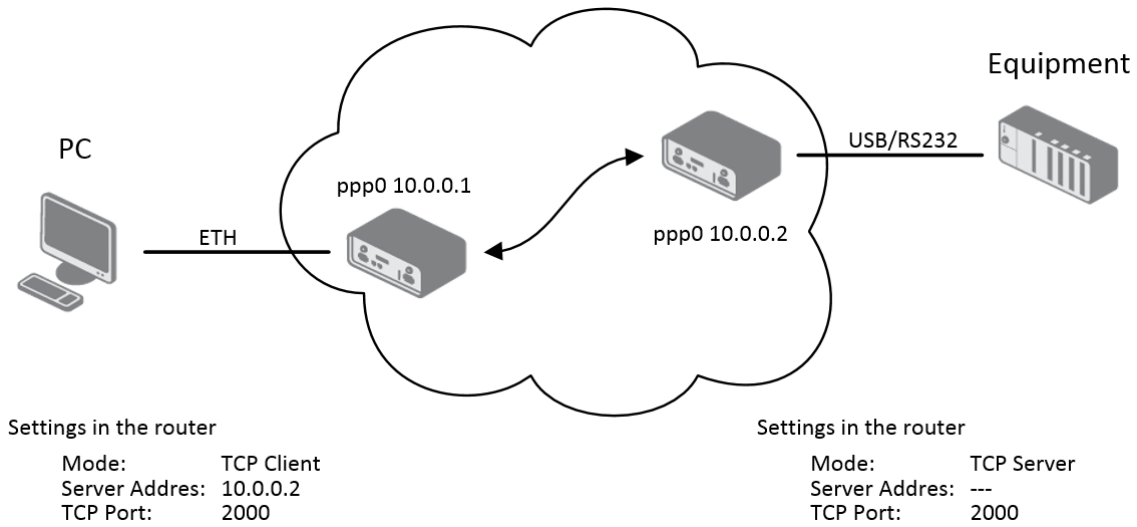

Figure 94: Example 2 – USB port configuration

3.22 Scripts

There is an option to create your own shell scripts that are executed in specific situations. There are three subpages under the *Scripts* page in the *Configuration* section: *Startup*, *Up/Down IPv4*, and *Up/Down IPv6*.

- The script defined on the *Startup* page is executed after the router starts up, either from powering on or resetting.
- The *Up/Down* script is executed when the WAN connection is either established (up) or lost (down).

For more details, see the following subchapters. For console configuration commands, refer to the *Command Line Interface* Application Note. For more information on enhancing the router's basic functionality, refer to the *Extending Router Functionality* Application Note.

3.22.1 Startup Script

Use the *Startup Script* window to create your own scripts which will be executed after all of the initialization scripts are run – right after the router is turned on or rebooted. To save the script press the *Apply* button.



Any changes made to a startup script will take effect next time the router is power cycled or rebooted. This can be done with the *Reboot* button in the *Administration* section, or by SMS message.

3.22.2 Example of Startup Script

```

Startup Script

#!/bin/sh
#
# This script will be executed *after* all the other init scripts.
# You can put your own initialization stuff in here.

killall syslogd
syslogd -R 192.168.2.115 -S 100
  
```

Figure 95: Example of a Startup Script

When the router starts up, stop `syslogd` program and start `syslogd` with remote logging on address 192.168.2.115 and limited to 100 entries. Add these lines to the startup script:

```
killall syslogd
```

```
syslogd -R 192.168.2.115 -S 100
```

3.22.3 Up/Down Scripts

Use the *Up/Down IPv4* and *Up/Down IPv6* page to create scripts executed when the WAN connection is established (up) or lost (down). There is an independent IPv4 and IPv6 dual-stack implemented in the router, so there is independent IPv4 and IPv6 Up/Down script. *IPv4 Up/Down Script* runs only on the IPv4 WAN connection established/lost, *IPv6 Up/Down Script* runs only on the IPv6 WAN connection established/lost. Any scripts entered into the *Up Script* window will run after a WAN connection is established. Script commands entered into the *Down Script* window will run when the WAN connection is lost.

The changes in settings will apply after pressing the *Apply* button. Also you need to reboot the router to make Up/Down Script work.

3.22.4 Example of IPv6 Up/Down Script

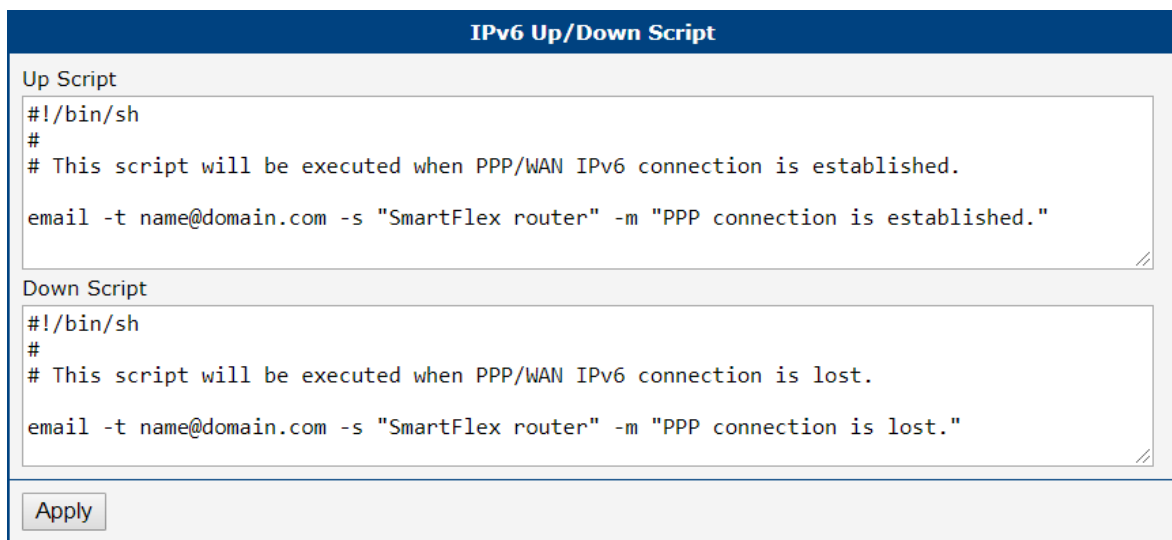

```
IPv6 Up/Down Script

Up Script
#!/bin/sh
#
# This script will be executed when PPP/WAN IPv6 connection is established.
email -t name@domain.com -s "SmartFlex router" -m "PPP connection is established."

Down Script
#!/bin/sh
#
# This script will be executed when PPP/WAN IPv6 connection is lost.
email -t name@domain.com -s "SmartFlex router" -m "PPP connection is lost."

Apply
```

Figure 96: Example of IPv6 Up/Down Script

After establishing or losing an IPv6 WAN connection, the router sends an email with information about the connection state. It is necessary to configure *SMTP* before.

Add this line to the *Up Script* field:

```
email -t name@domain.com -s "Router" -m "Connection up."
```

Add this line to the *Down Script* field:

```
email -t name@domain.com -s "Router" -m "Connection down."
```

3.23 Automatic Update

The router can be configured to automatically check for firmware updates from an FTP site or a web server and update its firmware or configuration information; see Figure 97 and Table 76.

Automatic Update

Enable automatic update of configuration

Enable automatic update of firmware

Source HTTP(S) / FTP(S) ▼

Base URL

Unit ID *

Decryption Password *

Update Window Start dynamic ▼

Update Window Length * min

Skip Certificate Verification

Use Custom CA Certificate

CA Certificate *

** can be blank*

Figure 97: Automatic Update

Item	Description
Enable automatic update of configuration	If enabled and if there is a new configuration file, it will update it and reboot.
Enable automatic update of firmware	If enabled and if there is a new firmware, it will update it and reboot.
Source	Select the location of the update files: <ul style="list-style-type: none"> HTTP(S)/FTP(S) server – Updates are downloaded from the Base URL address below. The used protocol is specified by that address: HTTP, HTTPS, FTP, or FTPS (only implicit mode is supported). USB flash drive – The router finds the current firmware or configuration in the root directory of the connected USB device. Both – Looking for the current firmware or configuration from both sources.
Base URL	Base URL, IPv4, or IPv6 address from which the configuration file will be downloaded. This option also specifies the communication protocol (HTTP, HTTPS, FTP, or FTPS), see examples below.

Continued on the next page

Continued from previous page

Item	Description
Unit ID	Name of configuration (name of the file without extension). If the <i>Unit ID</i> is not filled, the MAC address of the router is used as the filename (the delimiter colon is used instead of a dot).
Decryption Password	Password for decryption of the encrypted configuration file. This is required only if the configuration is encrypted.
Update Window Start	Choose an hour (range from 1 to 24) when the automatic update will be performed on a daily basis. If the time is not specified (set to <i>dynamic</i>), the automatic update is performed five minutes after the router boots up and then regularly every 24 hours.
Update Window Length	This value defines the period within which the update will be done. This period starts at the time set in the <i>Update Window Start</i> field. The exact time, when the update will be done, is generated randomly.
Skip Certificate Verification	If enabled, the server certificate validation is not executed.
Use Custom CA Certificate	If enabled, the server certificate validation is executed to verify server identity.
CA Certificate	CA certificate to validate on the server.

Table 76: Automatic Update Options

To prevent possible unwanted manipulation of the files, the router verifies that the downloaded file is in the `tar.gz` format. First, the format of the downloaded file is checked. Then, the type of architecture and each file in the archive (`tar.gz` file) is checked.

The **configuration file** name consists of the *Base URL*, the hardware MAC address of the ETH0 interface, and the `cfg` extension. The hardware MAC address and `cfg` extension are added to the file name automatically, so it is not necessary to enter them. When the parameter *Unit ID* is enabled, it defines the specific configuration name that will be downloaded to the router, and the hardware MAC address in the configuration name will not be used.

The **firmware file** name consists of the *Base URL*, the type of router, and the `bin` extension. For the proper firmware filename, see the *Update Firmware* page in the *Administration* section; it is written there, see Chapter 5.11.



It is necessary to load two files (`*.bin` and `*.ver`) to the server. If only the `*.bin` file is uploaded and the HTTP(S) server sends an incorrect `200 OK` response (instead of the expected `404 Not Found`) when the device tries to download the nonexistent `*.ver` file, the router may download the `.bin` file repeatedly.



Firmware update can cause incompatibility with the router apps. It is recommended that you update router apps to the most recent version. Information about the router apps and firmware compatibility is provided at the beginning of the router app's Application Note.



The automatic update feature is also executed five minutes after the firmware upgrade, regardless of the scheduled time.

3.23.1 Example of Automatic Update

In the following example, the router is configured to check for new firmware or a configuration file daily at 1:00 a.m. This scenario is specifically tailored for ICR-4401 router.

- Firmware file: `https://example.com/icr-440x.bin`
- Configuration file: `https://example.com/test.cfg`

Automatic Update

Enable automatic update of configuration

Enable automatic update of firmware

Source

Base URL

Unit ID *

Decryption Password *

Update Window Start

Update Window Length * min

** can be blank*

Figure 98: Example of Automatic Update

3.23.2 Example of Automatic Update Based on MAC

The example provided demonstrates how to check for new firmware or configurations daily between 1:00 a.m. and 3:00 a.m. The configuration file is encrypted, necessitating the setup of a decryption password. This specific example is applicable to ICR-4161 router with the MAC address 00:11:22:33:44:55.

- Firmware file: <https://example.com/icr-416x.bin>
- Configuration file: <https://example.com/00.11.22.33.44.55.cfg>

Automatic Update

Enable automatic update of configuration

Enable automatic update of firmware

Source

Base URL

Unit ID *

Decryption Password *

Update Window Start

Update Window Length * min

** can be blank*

Figure 99: Example of Automatic Update Based on MAC

4. Customization

4.1 Router Apps



A user with the *User* role can only view the installed Router Apps. Management of Router Apps is allowed only for users with the *Admin* role.

Router Apps (RA), formerly known as *User Modules*, enhance router functionality through custom software programs. These apps extend the router's capabilities in areas such as security and advanced networking, offering a flexible and customizable experience.

For Advantech routers, a diverse array of Router Apps is offered, encompassing categories such as connectivity, routing, services, among others. These applications are freely accessible on the Advantech [Router Apps](#) webpage, providing users with a wide range of options to enhance the functionality of their devices.

Figure 100 illustrates the default layout of the *Router Apps* configuration interface. The initial segment, titled *Installed Apps*, presents a comprehensive list of Router Apps currently installed on the device. The subsequent section, *Manual Installation*, provides the functionality for manually adding Router Apps to the system. The *Free Space* row indicates the available space. Lastly, the third section facilitates the online acquisition and installation of Router Apps accessible from a public server.

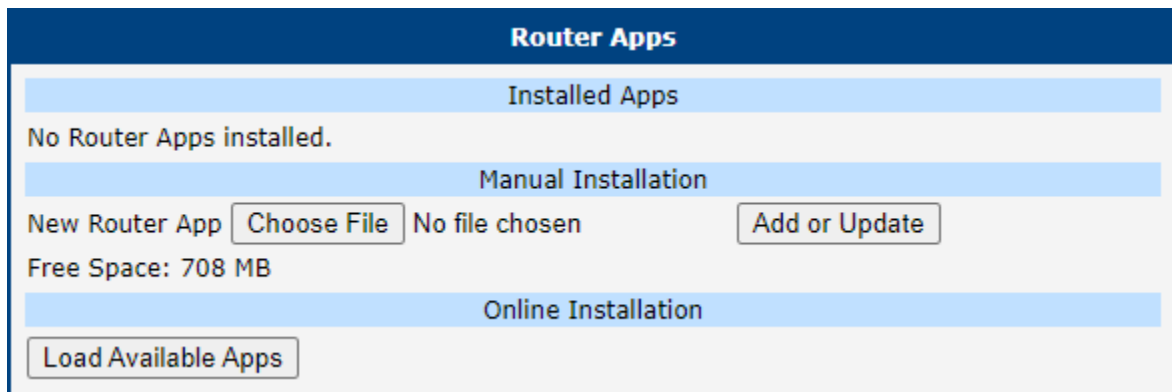

Figure 100: Default Router Apps GUI

Manual RA Installation and Update

For the manual installation of a RA, prepare the application package with a `*.tgz` extension. In the router interface, use the *Choose File* button to select your file and the *Add or Update* button to start the installation.

Online RA Installation and Update

To install Router Apps from the public server, it is imperative to first ensure that the router is correctly configured and connected as outlined in Chapter 4.2. By default, routers are set to automatically connect to the public Advantech server. To proceed with the installation, click on the *Load Available Apps* button, which initiates the loading of a comprehensive list of RA that are available on the server for installation.

Keep these notes in mind:

- The online RA installation functionality starts with firmware version 6.4.0 and is not available for the v2 production platform.
- Note that an Internet connection is required to access the public server. Without it, you will encounter an error: "Cannot get auth header: Couldn't resolve host name".

- The list of online applications is updated only when the *Reload Available Apps* button is pressed. The last loading timestamp is visible next to this button.
- If the router is rebooted, the list of applications is cleared and needs to be reloaded.
- The *Load Available Apps* button is deactivated if the connection to the server is disabled.

Figure 101 displays an instance where the assortment of online applications accessible for installation has been successfully loaded. This figure further demonstrates that only the *Customer Logo* application, version v1.0.0, is installed on the local device, as indicated by its solitary listing in the *Installed Apps* section.

Within the *Online Installation* section, it is highlighted that an updated version of the *Customer Logo* application, version v1.1.0, is available for download from the server, showcasing the potential for upgrading existing applications directly through the router’s interface.

The screenshot shows the 'Router Apps' interface. It is divided into three main sections: 'Installed Apps', 'Manual Installation', and 'Online Installation'.
 - **Installed Apps:** Shows 'Customer Logo v1.0.0 (2020-01-31)' with a 'Delete' button.
 - **Manual Installation:** Includes a 'New Router App' section with a 'Choose File' button (showing 'No file chosen') and an 'Add or Update' button.
 - **Online Installation:** Features a 'Reload Available Apps' button and a 'Last check' timestamp of '2024-01-15 10:39:55'. Below this is a list of available apps, each with a version dropdown and an 'Install' button:
 - 802.1X Authenticator (v1.1.0): 802.1X network authentication standard for devices on LAN/WLAN.
 - Azure IoT SDK Python (v1.0.0): Add Microsoft Azure IoT Hub Device SDK for Python to router [Obsolete version].
 - Customer Logo (v1.0.0 / v1.1.0): Allow users to change the logo displayed in the header of the web interface.
 - Unique Password (v1.0.2): unique. From January 2020, this is required by California Senate Bill No. 327. The format used is 'Ph'.
 - WebAccess/VPN Client (v1.1.3): This user module allows the router to be part of WebAccess/VPN.
 - WiFi STA Relay (v1.3.0): Set the router to transparent mode (WiFi interface in client mode bridged to ETH). [Limited to specific router models].
 - Zabbix Agent (v5.0.3-1): Agent for Zabbix network monitoring platform.

Figure 101: Router Apps GUI with Available Online Apps

RA Management

Installed Router Apps, regardless of whether they were installed manually or from the server, appear in the *Installed Apps* section.

Apps with an `index.html` or `index.cgi` page have a clickable link in their name. Clicking on this link opens the GUI of the respective application.

To remove an app, click the *Delete* button, which is located next to the respective application in the *Installed Apps* section.



The programming and compiling of router applications is described in the Application Note *Programming of Router Apps* [14].

4.2 Settings

To configure the connection settings for the online application hosting server, navigate to the *Customization* → *Settings* menu option. Figure 102 and Table 77 offer comprehensive details regarding the configuration parameters for the server, ensuring users can effectively customize their router to connect to the online application hosting server.

Figure 102: Router Apps Settings

Item	Description
Disable server communication	Connection to the server is disabled, preventing any data exchange with the online application hosting server.
Use public server	Opt to utilize the public server, managed by Advantech, as the primary source for Router Apps. This is the default configuration. An active internet connection is mandatory for accessing the server.
Use custom server ¹	Select this option to establish a connection with a self-hosted server that adheres to the Advantech specifications for Router Apps.
API URL	Enter the URL for the self-hosted server, ensuring the inclusion of the 'https://' prefix to denote a secure connection.
CA certificate	Provide the certificate for the self-hosted server, especially if it utilizes a Certificate Authority (CA) that is not widely recognized or standard.

Table 77: Router Apps Settings

¹Operating your own self-hosted server is feasible exclusively with an on-premises installation of the *WebAccess/DMP* product by Advantech.

5. Administration

5.1 Manage Users



Be careful not to lock out all users with the *Admin* role. In this state, no user will have the rights to configure user accounts!

- This configuration menu is available only to users with the *Admin* role.
- For user authentication settings, such as two-factor authentication and account locking rules, refer to Chapter 3.20.1.
- The user will be prompted to change their password in the following situations:
 - When logging into the new router for the first time.
 - When a user's password has been forcefully changed by a user with the *Admin* role upon their first login.
 - When a *Configuration Reset* or *Factory Reset* is performed on the router.



To manage users, open the *Manage Users* form in the *Administration* section of the main menu, as shown in Figure 103. In this figure, you can see that there are two users defined on the router: `root` with the *Admin* role, and the user `Alice` with the *User* role. By clicking the *Add User* button, the user `John` (whose data is filled in the form) will be added to the router.

The screenshot shows the 'Manage Users' interface. At the top, there are two existing users listed: 'root' with the role 'Admin' and 'Alice' with the role 'User'. Each user has buttons for 'Lock', 'Modify', and 'Delete'. Below the list is a form to add a new user. The form fields are: Role (dropdown menu set to 'Admin'), Username (text input 'John'), New Password (password input with a strength indicator and a list of requirements: 'Must be at least 6 characters long', 'Must not be palindrome', 'Must not contain username'), Confirm Password (password input), SSH Public Key (text area containing a long alphanumeric string and a 'Load From File...' button), Phone Number (text input '+15551234567'), and Email Address (text input 'address@email.com'). An 'Add User' button is at the bottom left of the form.

Figure 103: Modify User Page

The first part of this configuration form contains a list of all existing users. Table 78 describes the meaning of the buttons located to the right of each user.

Button	Description
Lock	Locks the user account. This user is not allowed to log in to the router, either to the web interface or via SSH.
Modify	Allows you to change the password or key for the corresponding user, see Chapter 5.2.
Delete	Deletes the user account.

Table 78: Action Button Description

The second part of the configuration form allows adding a new user. All items are described in Table 79. To create a new user, configure all required items and click the *Add User* button.

Item	Description
Role	<ul style="list-style-type: none"> • User <ul style="list-style-type: none"> ○ User with basic permissions. ○ Read-only access to the web GUI, except for <i>Modify User</i>. ○ Some menu items are hidden in the web GUI. ○ Read-only access to the <i>Router Apps</i> GUI. ○ No access to the router via Telnet, SSH or SFTP. ○ Read-only access to the FTP server. • Admin <ul style="list-style-type: none"> ○ User with enhanced permissions. ○ Full access to all items in the web GUI. ○ Access to the router via Telnet, SSH or SFTP. ○ Not the same rights as the superuser on a Linux-based system.
Username	Specifies the name of the user having access to log in to the device.
New Password	Specifies the password for the user. It must match the rules stated in the GUI, which depend on the <i>Force Password Complexity</i> level set in <i>Configuration → Services → Authentication</i> , as described in Chapter 3.20.1.
Confirm Password	Confirms the password.
Public key	Enter the SSH Public Key to enable passwordless SSH login. Refer to Chapter 5.2.2 for details.
Phone Number	User's phone number. If configured, an SMS is sent to the user when their password is changed. A functional SIM card is required.
Email Address	User's email address. If configured, an email is sent to the user when their password is changed. SMTP must be configured.
Add User	Click this button to create a new user based on the entries in the fields above.

Table 79: User Parameters

5.2 Modify User



- This configuration menu is only available for users with the *User* role. Such users can only modify their own account.
- To view the current user authentication configuration settings, such as two-factor authentication and account locking rules, refer to Chapter 3.20.1

If a user with a *User* role is logged in, they can manage only their user account. This can be done on the *Administration* → *Modify User* page. You will get the same configuration page if you have the *Admin* role when modifying another user account on the *Manage Users* page.

Modify User

Username: root

New Password: [Strength indicator]

Confirm Password: [Strength indicator]

SSH Public Key *
ssh-rsa
AhAds3NzaC1ycg2fhEAAAADAQABAAQfBAQCilkmRYGkMYZYFYfTBjbz0fwE53aJ7
/XTFhGmsDbSHTig1sflsIsSsMxFkIFFchhgLfa64iu9DiuHVrerHo/GIyOw49Z6itt
q3IFxfFhrs7RghdhFF9sFaLjBgvcPyfs947radhfdVVeIMD0k0kjUhy5FLj9c03vdQC
FowkmNKhwPpsdVDuBUvhfBfhgbbYu1l/avoV+L2u1dMfhgfixfbjxxL72o+brwJ3vqT
UtBv9tTdb6rqvmoF6VvVU4+G/F9gfgxhf7110NA4RKtGEPuB+fmZ34EHqT7crvqx8Zu
qUluqXq0Wyltj/D2dsitSMaqsBVZa5FY4fue+h2+tmUJgffIXN/d6MAgnSFQ+u3
rsa-key-20240918

Phone Number *: +15551234567

Email Address *: address@email.com

Two-Factor Auth: Google Authenticator (TFA is enabled/disabled via Services/Authentication)

Secret Key: [Show]

Keep the current secret key
 Generate a new secret key
 Upload a new secret key
 Delete the secret key

Secret Key File: Choose File No file chosen

Apply

Figure 104: Users Administration Form

The meaning of the items in the first part of this window is clear or described in more detail in Chapter 5.1. If you want to change your own password, you will need to enter the current password as well. In the second part, you can configure two-factor authentication for a user, including its secret key.

5.2.1 Two-Factor Authentication



If the configuration of two-factor authentication fails or does not complete properly, you will be unable to log in to the router using that user account. It is recommended to set up a backup account to log in to the router in case issues arise during the configuration process. You can delete this backup account after successfully configuring two-factor authentication.



To successfully log in using two-factor authentication, the correct system time must be set on the router. Therefore, it is strongly recommended to enable the *Synchronize clock with remote NTP server* option. For more details, refer to Chapter [3.20.5 NTP](#).

If you have enabled one of the two-factor authentication services, as mentioned above, you should see the chosen service name in the *Two-Factor Auth* field, as shown in Figure [104](#).

A secret key is required to activate the two-factor authentication. You can generate this key by choosing the *Generate a new secret key* option. You can upload the user's secret key from a file using *Upload a new secret key*. Clicking the *Apply* button the secret key will be saved. Next, click the *Show* button, located to the right of the secret key, the secret key will be shown. If the secret key is defined, a QR code will appear on the right, allowing you to easily add this key to the chosen authentication application by scanning it, see section [Authenticator](#)



Without the secret key, a user will not be able to finish two-factor configuration and log in to the router.



A user with the *Admin* role cannot generate or upload the secret key for another user; they can only delete the key.

Implementation Notes

- Two different two-factor implementations are supported:
 - [Google Authenticator](#),
 - [OATH Toolkit](#).
- Implemented for the following services only:
 - the router's web server login,
 - SSH login,
 - TELNET login.
- Two-factor authentication is disabled by default.
- Two-factor authentication data are backed up/restored during user backup/restore.
- All private two-factor authentication data are removed when the corresponding user is deleted.
- No internet or mobile connection is required to use two-factor authentication, but keep in mind the need to synchronize the system time.

Configuration Steps

1. Enable the two-factor authentication service as described in Chapter 3.20.1.
2. Enable the two-factor authentication for a user as described in Chapter 5.2.
3. Use an application or service to perform the two-factor authentication to the router as described in following *Authenticator* Chapter.

Authenticator

To log in with two-factor authentication, you need an Authenticator application. Both *Google Authenticator* and *OATH* use TOTP (Time-based One-Time Password, RFC 6238) mode by default. You can use any compatible authenticator. For information about authenticator usage, see the corresponding manual.

You can use the [Google Authenticator](#) application; see Figure 105 for the download links.

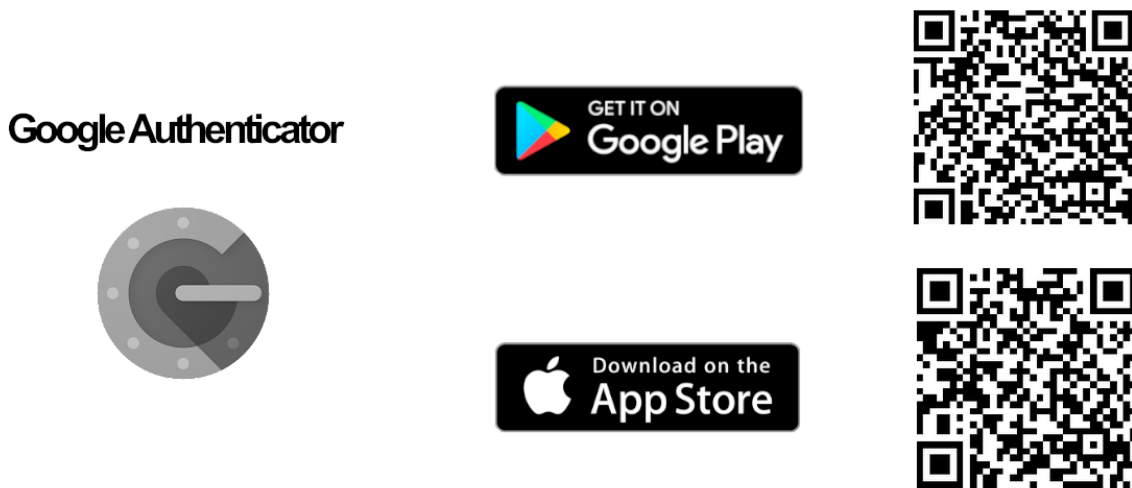

Figure 105: Links for Google Authenticator Application

[Authenticator-Extension](#) is available as an extension for all popular browsers; see Figure 106 for the download links.

Authenticator-Extension / Authenticator



Figure 106: Links for Authenticator-Extension

In an Authenticator application, you can create a new entry by entering the secret key you have noted down or by scanning the QR code shown for the user on the *Modify User* configuration page.

Router Web Login

When logging into the router's web interface, enter the *Username* and *Password* as you would for a standard login; see Figure 107.

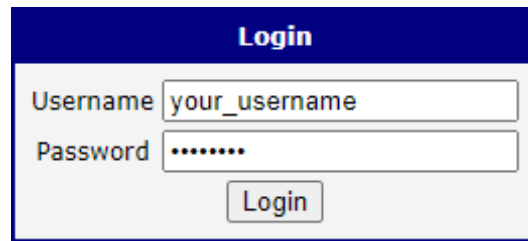

Figure 107: Standard Login

Next, you will be prompted to enter the Verification Code; see Figure 108. This code is obtained from your Authenticator. Note that there is a **limited time** for code usage, typically within five minutes, assuming the system time is correct.

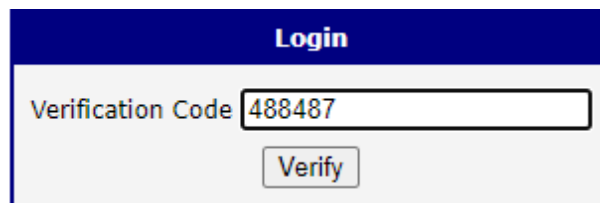

Figure 108: Verification Code

After entering the correct code, you will be successfully logged in to the router's web interface.

SSH and Telnet Login

Logging into SSH and Telnet with two-factor authentication is similar. Enter your username, password, and the generated verification code. For an example of SSH login, see Figure 109.

```
login as: your_username
Using keyboard-interactive authentication.
Password:
Using keyboard-interactive authentication.
Verification code:
$ █
```

Figure 109: SSH Login

5.2.2 Passwordless Console Login

You can log in to SSH without a password using the SSH Public Key. The process of key generation and connection will be demonstrated in this chapter using *PuTTY*, a free terminal emulator for Windows OS.

Installation Notes

- For simplicity and clarity, we will perform a manual installation of PuTTY to the directory `C:\bin`, instead of using an `.msi` installation package.
- From the PuTTY application [download page](#), under the section *Alternative binary files*, download the individual files named `putty.exe`, `puttygen.exe`, and `pageant.exe`. You will likely want the 64-bit x86 version. We use *PuTTY* version 0.80. Save these files to the `C:\bin` directory.

Generate Keys

- Run the downloaded `puttygen.exe` application to create your SSH key, see Figure 110.
- Ensure the *RSA* option is selected.
- Click the *Generate* button. Move your mouse within the window to generate the keys.
- Once complete, the key data appears.

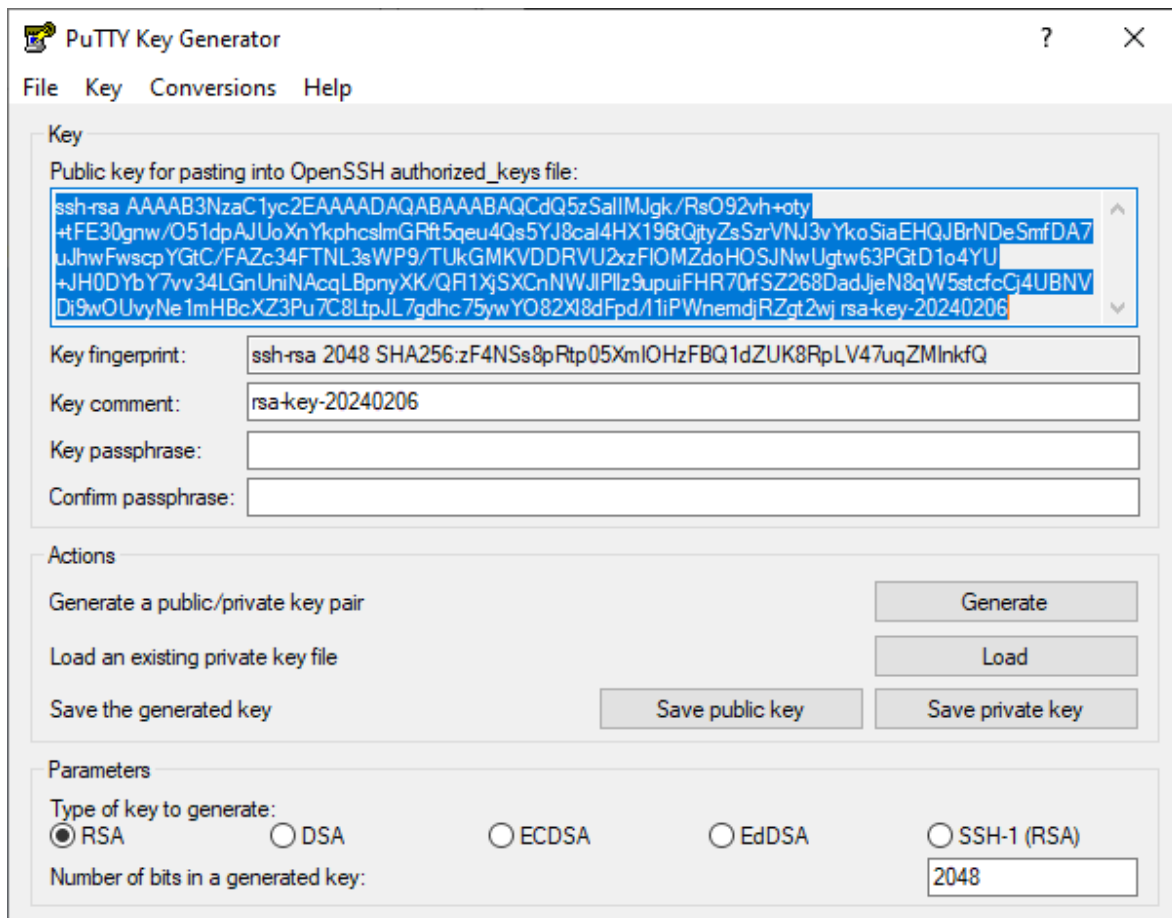

Figure 110: Key Generation

- Click both *Save public key* and *Save private key* buttons to save these keys on your computer:
 - Name the public key something like *hostpublickey* and the private key something like *hostprivatekey*, without manually adding extensions.
 - If prompted about a passphrase, click *Yes* to save without a passphrase.
- Leave the *PuTTY Key Generator* application open.

Uploading Public Key to the Router:

- In the router GUI (*Administration* → *Manage Users*), click the *Modify* button for the user to whom you want to add the public key. Ensure the user has the *Admin* role, since a user with the *User* role is not permitted for SSH login.
- Enter the generated public key for the user:
 - In the *PuTTY Key Generator*, select the entire public key as demonstrated in Figure 110 with the key data selected (in blue), and copy it to the clipboard.
 - In the router GUI, paste the key into the *SSH Public Key* field.
 - It is important that the key **starts with "ssh-rsa "** followed by the key itself.
- Save the user settings by clicking the *Apply* button.
- Now, you can close the *PuTTY Key Generator* application.

PuTTY Session Configuration

- Open the `c:\bin\putty.exe` application.
- In the configuration window, navigate to *Connection* → *Data* and enter the username (the router's user to whom the public key was saved) in the *Auto-login username* field.
- Under *Connection* → *SSH* → *Auth* → *Credentials*, click the *Browse* button near the *Private key file for authentication* field, and select your *hostprivatekey* file generated according to the steps above.
- In the configuration window, navigate to the *Session* menu item and configure the following:
 - *Host Name*: IP address of your router.
 - *Port*: 22.
 - *Connection Type*: SSH.
 - *Saved Session*: Enter a name for this session.
 - Click *Save* to store these session settings.

Connecting to the Router

- Open the `c:\bin\putty.exe` application.
- Select and load your session with the *Load* button.
- Click *Open* to establish the connection.
- If everything is configured correctly, an SSH console prompt will open with the user logged in.

5.2.3 Expired Password

If the password expires after the number of days defined in *Expire Password After* has passed, the user will be prompted to enter a new password as shown in Image 111. The new password must match the rules stated in the GUI, which depend on the *Force Password Complexity* level set in *Configuration* → *Services* → *Authentication*, as described in Chapter 3.20.1.

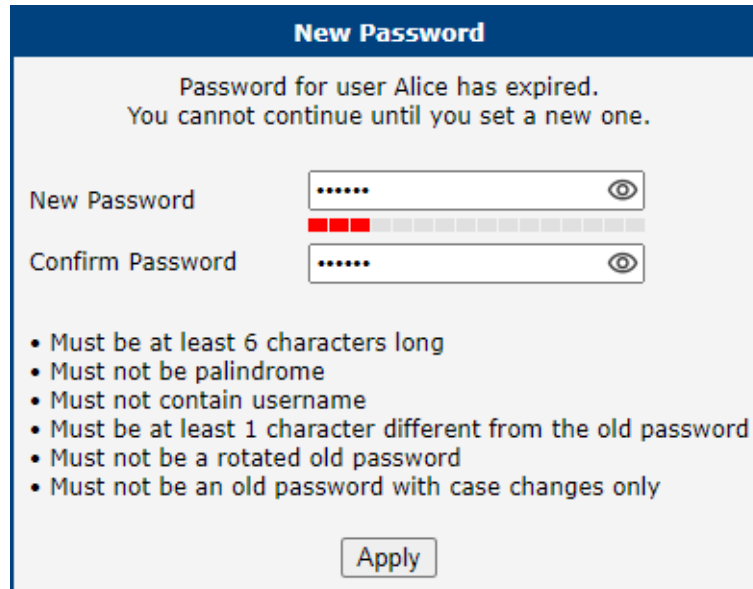

New Password

Password for user Alice has expired.
You cannot continue until you set a new one.

New Password

Confirm Password

- Must be at least 6 characters long
- Must not be palindrome
- Must not contain username
- Must be at least 1 character different from the old password
- Must not be a rotated old password
- Must not be an old password with case changes only

Apply

Figure 111: Expired Password Prompt

5.3 Change Profile

In addition to the standard profile, up to three alternate router configurations or profiles can be stored in router's non-volatile memory. You can save the current configuration to a router profile through the *Change Profile* menu item. Select the alternate profile to store the settings to and ensure that the *Copy settings from current profile to selected profile* box is checked. The current settings will be stored in the alternate profile after the *Apply* button is pressed. Any changes will take effect after restarting router through the *Reboot* menu in the web administrator or using an SMS message.

Example of using profiles: Profiles can be used to switch between different modes of operation of the router such as PPP connection, VPN tunnels, etc. It is then possible to switch between these settings using the front panel binary input, an SMS message, or Web interface of the router.

Change Profile	
Profile	Standard ▼
<input type="checkbox"/> Copy settings from current profile to selected profile	
<input type="button" value="Apply"/>	

Figure 112: Change Profile

5.4 Set Date and Time



This administration page is not for configuring the NTP client, but only for one-time date and time settings. For permanent NTP client configuration, please go to the *Configuration* → *Services* → *NTP* page.

There are three ways to set the system date and time on a one-time basis, as shown in the figure below:

1. **Set current browser time:** This option sets the device's clock to match the time displayed on your web browser.
2. **Set specific date/time:** You can manually input the date and time. Ensure you adhere to the **yyyy-mm-dd** format for the date. For the time, use the **HH:MM:SS** format. **Note:** The time preloaded is the browser time, not the router time.
3. **Query NTP server:** To query the date and time from an NTP server, input the address of the NTP server. The system supports both IPv4 and IPv6 addresses, as well as domain names.

Set Date and Time	
<input checked="" type="radio"/> Set current browser time	
<input type="radio"/> Set specific date / time	
Date	<input type="text" value="2024 - 05 - 23"/>
Time	<input type="text" value="12 : 34 : 28"/>
<input type="radio"/> Query NTP server	
NTP Server Address	<input type="text" value="pool.ntp.org"/>
<input type="button" value="Apply"/>	

Figure 113: Set Real Time Clock

5.5 Set SMS Service Center Address



This feature works on the 1st cellular module only! (1st or 2nd SIM card.) It is not possible to set the SMS Service Center on the 2nd cellular module this way.

The function requires you to enter the phone number of the SMS service center to send SMS messages. To specify the SMS service center phone number use the *Set SMS Service Center* configuration form in the *Administration* section of the main menu. You can leave the field blank if your SIM card contains the phone number of the SMS service center by default. This phone number can have a value without an international prefix (xxx-xxx-xxx) or with an international prefix (+420-xxx-xxx-xxx). If you are unable to send or receive SMS messages, contact your carrier to find out if this parameter is required.

Figure 114: Set SMS Service Center Address

5.6 Unlock SIM Card



This feature works on the 1st cellular module only! (1st or 2nd SIM card.) It is not possible to unlock SIM card in 2nd cellular module this way.

It is possible to use the SIM card protected by PIN number in the router – just fill in the PIN on the *Mobile WAN Configuration* page. Here you can remove the PIN protection (4–8 digit Personal Identification Number) from the SIM card, if your SIM card is protected by one. Open the *Unlock SIM Card* form in the *Administration* section of the main menu and enter the PIN number in the *SIM PIN* field, then click the *Apply* button. It is applied on the currently enabled SIM card, or on the first SIM card if there is no SIM card enabled at the moment.



The SIM card is blocked after three failed attempts to enter the PIN code. Unlocking of SIM card by PUK number is described in next chapter.

Figure 115: Unlock SIM Card

5.7 Unblock SIM Card



This feature works on the 1st cellular module only! (1st or 2nd SIM card.) It is not possible to unblock SIM card in 2nd cellular module this way.

On this page you can unblock the SIM card after 3 wrong PIN attempts or change the PIN code of the SIM card. To unblock the SIM card, go to *Unblock SIM Card* administration page. In both cases enter the PUK code into *SIM PUK* field and new SIM PIN code into *New SIM PIN* field. To proceed click on *Apply* button. It is applied on the currently enabled SIM card, or on the first SIM card if there is no SIM card enabled at the moment.



The SIM card will be permanently blocked after the three unsuccessful attempts of the PUK code entering.

Unblock SIM Card	
SIM PUK	<input type="text"/>
New SIM PIN	<input type="text"/>
<input type="button" value="Apply"/>	

Figure 116: Unblock SIM Card

5.8 Send SMS



This feature works on the 1st cellular module only! (1st or 2nd SIM card.) It is not possible to send SMS from 2nd cellular module this way.

You can send an SMS message from the router to test the cellular network. Use the *Send SMS* dialog in the *Administration* section of the main menu to send SMS messages. Enter the *Phone number* and text of your message in the *Message* field, then click the *Send* button. The router limits the maximum length of an SMS to 160 characters. (To send longer messages, install the *pduSMS* router app).

The screenshot shows a web-based dialog titled "Send SMS". It features a dark blue header bar with the text "Send SMS" in white. Below the header, the form is divided into two main sections. The first section is labeled "Phone number" and contains a single-line text input field. The second section is labeled "Message" and contains a large, multi-line text area with a small cursor icon at the bottom right. At the bottom left of the dialog, there is a button labeled "Send".

Figure 117: Send SMS

It is also possible to send an SMS message using CGI script. For details of this method. See the application note *Command Line Interface* [1].

5.9 Backup Configuration



Keep in mind potential security issues when creating a backup, especially for user accounts. Encrypted configuration or a secured connection to the router should be used.

You can save the current configuration of the router using the *Backup Configuration* item in the *Administration* menu section. If you click on this item, a configuration pane will open, see Figure 118. Here you can choose what will be backed up. You can back up the configuration of the router (item *Configuration*) or the configuration of all user accounts (item *Users*). Both types of configurations can be backed up separately or together into one configuration file.



It is recommended to save the configuration into an encrypted file. If the encryption password is not configured, the configuration is stored in an unencrypted file.

Click on the *Apply* button and the configuration will be stored into a configuration file (file with *cfg* extension) in a directory according to the settings of the web browser. The stored configuration can be used later for restoration, see Chapter 5.10 for more information.

Backup Configuration	
<input checked="" type="checkbox"/>	Backup configuration
<input type="checkbox"/>	Backup users
Encryption Password *	<input type="text"/>
* can be blank	
<input type="button" value="Save Backup"/>	

Figure 118: Backup Configuration

5.10 Restore Configuration

You can restore a router configuration stored in a file. You created the file as shown in the previous chapter.

To restore the configuration from this file, use the *Restore Configuration* form. Next, click the *Browse* button to navigate to the directory containing the configuration file you wish to load to the router. If the configuration was stored in an encrypted file, the decryption password must be set to decrypt the file successfully. To start the restoration process, click on the *Apply* button.

Restore Configuration	
Configuration File	<input type="button" value="Choose File"/> No file chosen
Decryption Password *	<input type="password"/> <input type="button" value="👁"/>
* can be blank	
<input type="button" value="Apply"/>	

Figure 119: Restore Configuration

5.11 Update Firmware



The latest firmware for our routers is available on the Engineering Portal's product page. For downloading the appropriate firmware for your router model, please visit icr.advantech.com/download/routers-firmware.



- For enhanced security, it is strongly recommended to regularly update your router's firmware to the latest version. Avoid downgrading the firmware to a version older than the production release, and refrain from uploading firmware meant for different models, as these actions can lead to device malfunction.
- Be aware that firmware updates may cause compatibility issues with Router Apps. To minimize such issues, it is advisable to update all Router Apps to their latest versions concurrently with the router's firmware. Detailed compatibility information for each app is provided at the beginning of its Application Note.
- When using the HTTP protocol to communicate with the router (not recommended for security reasons), some advanced firewalls—especially those with AI capabilities—may falsely detect the firmware file content as insecure and block communication. In such cases, use HTTPS or ask your infrastructure administrator to remove the relevant rule.

The *Update Firmware* administration page showcases the current firmware version and the name of the router's firmware, as illustrated in Figure 120. This page also offers the capability to update the router's firmware, accommodating both manual updates and online updates from the public server.

Update Firmware	
Firmware Version : 6.3.9 (2023-01-04)	
Firmware Name : ICR-445x.bin	
New Firmware	<input type="button" value="Choose File"/> No file chosen <input type="button" value="Update"/>
<input type="button" value="Check for updates"/>	Last check 2024-01-18 12:06:55
Newest FW online 6.3.10 <input type="button" value="Download and Update"/>	

Figure 120: Update Firmware Administration Page

Manual Firmware Update

To manually update the router's firmware, click on the *Choose File* button and select the firmware file. Then, press the *Update* button to initiate the firmware update process.

Online Firmware Update

Starting with firmware version 6.4.0, the firmware can be updated from a public server. Ensure that your router is properly configured as described in Chapter 4.2.

To verify the availability of a newer firmware version on the server, click the *Check for updates* button. If a new version is available, the version information and a *Download and Update* button will appear. Clicking this button initiates the firmware update process.

During the firmware update, the router will display status messages as depicted in Figure 121. Upon completion, the router will automatically reboot. After rebooting, click the *here* link in the web interface to reopen it.

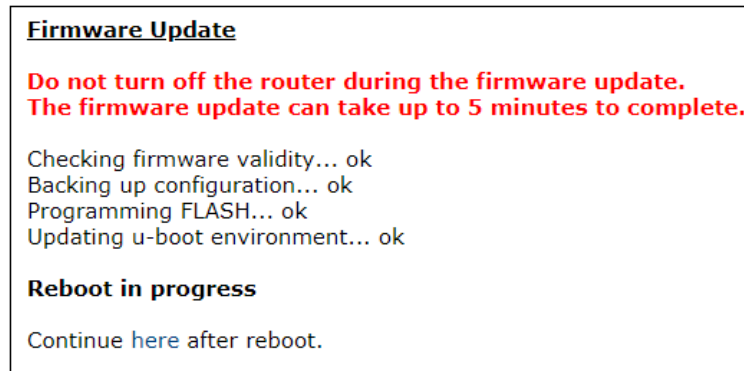

Figure 121: Process of Firmware Update

5.12 Reboot

To reboot the router select the *Reboot* menu item and then press the *Reboot* button.

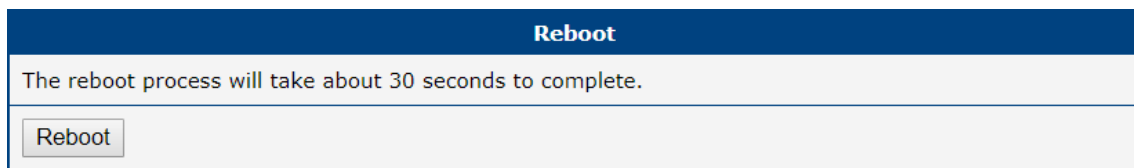

Figure 122: Reboot

5.13 Logout

By clicking the *Logout* menu item, the user is logged out from the web interface.

6. Typical Situations

Although Advantech routers have wide variety of uses, they are commonly used in the following ways. All the examples below are for IPv4 networks.

6.1 Access to the Internet from LAN

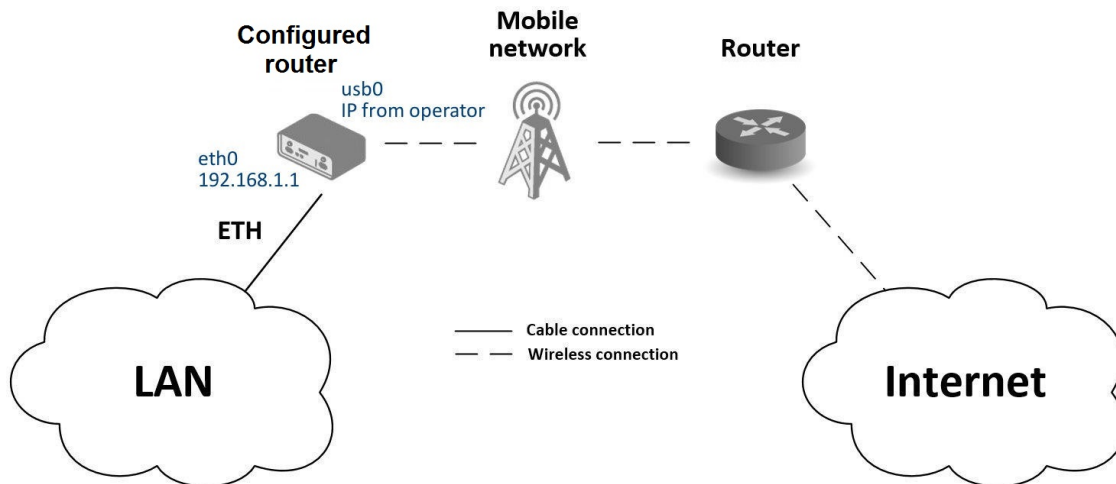

Figure 123: Access to the Internet from LAN – sample topology

In this example, a LAN connecting to the Internet via a mobile network, the SIM card with a data tariff has to be provided by the mobile network operator. This requires no initial configuration. You only need to place the SIM card in the *SIM1* slot (Primary SIM card), attach the antenna to the *ANT* connector and connect the computer (or switch and computers) to the router's eth0 interface (LAN). Wait a moment after turning on the router. The router will connect to the mobile network and the Internet. This will be indicated by the LEDs on the front panel of the router (*WAN* and *DAT*).

Additional configuration can be done in the *LAN* and *Mobile WAN* items in the *Configuration* section of the web interface.

LAN configuration The factory default IP address of the router's eth0 interface is in the form of 192.168.1.1. This can be changed (after login to the router) in the *LAN* item in the *Configuration* section. (See Figure 124.) In this case there is no need of any additional configuration. The DHCP server is also enabled by factory default (so the first connected computer will get the 192.168.1.2 IP address etc.). Other configuration options are described in the Chapter 3.1.

Mobile WAN Configuration Use the *Mobile WAN* item in the *Configuration* section to configure the connection to the mobile network, see Figure 125. In this case (depending on the SIM card) the configuration form can be blank. But make sure that *Create connection to mobile network* is checked (this is the factory default). For more details, see Chapter 3.5.1.

To check whether the connection is working properly, go to the *Mobile WAN* item in the *Status* section. You will see information about operator, signal strength etc. At the bottom, you should see the message: *Connection successfully established*. In problems check also the *Module Switching* page, there has to be *Create connection to mobile network* enabled, too.

Status	ETH0 Configuration	
General		
Mobile WAN		
Network		
DHCP		
IPsec		
DynDNS		
System Log		
Configuration		
Ethernet		
• ETH0		
• ETH1		
VRRP		
Mobile WAN		
PPPoE		
Backup Routes		
Static Routes		
Firewall		
NAT		

ETH0 Configuration		
	IPv4	IPv6
DHCP Client	disabled	disabled
IP Address	192.168.1.1	
Subnet Mask / Prefix	255.255.255.0	
Default Gateway		
DNS Server		
Bridged	no	
Media Type	auto-negotiation	
<input checked="" type="checkbox"/> Enable dynamic DHCP leases		
IP Pool Start	192.168.1.2	
IP Pool End	192.168.1.254	
Lease Time	600	600
		sec

Figure 124: Access to the Internet from LAN – Ethernet configuration

Status	1st Mobile WAN Configuration	
General		
Mobile WAN		
Network		
DHCP		
IPsec		
DynDNS		
System Log		
Configuration		
Ethernet		
VRRP		
Mobile WAN		
• 1st Module		
• 2nd Module		
• Module Switching		
PPPoE		
WiFi		
Backup Routes		
Static Routes		
Firewall		
NAT		

1st Mobile WAN Configuration		
<input checked="" type="checkbox"/> Create connection to mobile network		
	1st SIM card	2nd SIM card
APN *		
Username *		
Password *		
Authentication	PAP or CHAP	PAP or CHAP
IP Mode	IPv4	IPv4
IP Address *		
Dial Number *		
Operator *		
Network Type	automatic selection	automatic selection
PIN *		
MRU	1500	1500
		bytes
MTU	1500	1500
		bytes
DNS Settings	get from operator	get from operator

Figure 125: Access to the Internet from LAN – Mobile WAN configuration

The *Network* item should display information about the newly created network interface, usb0 (mobile connection). You should also see the IP address provided by the network operator, as well as the route table etc. The LAN now has Internet access.

6.2 Backup Access to the Internet from LAN

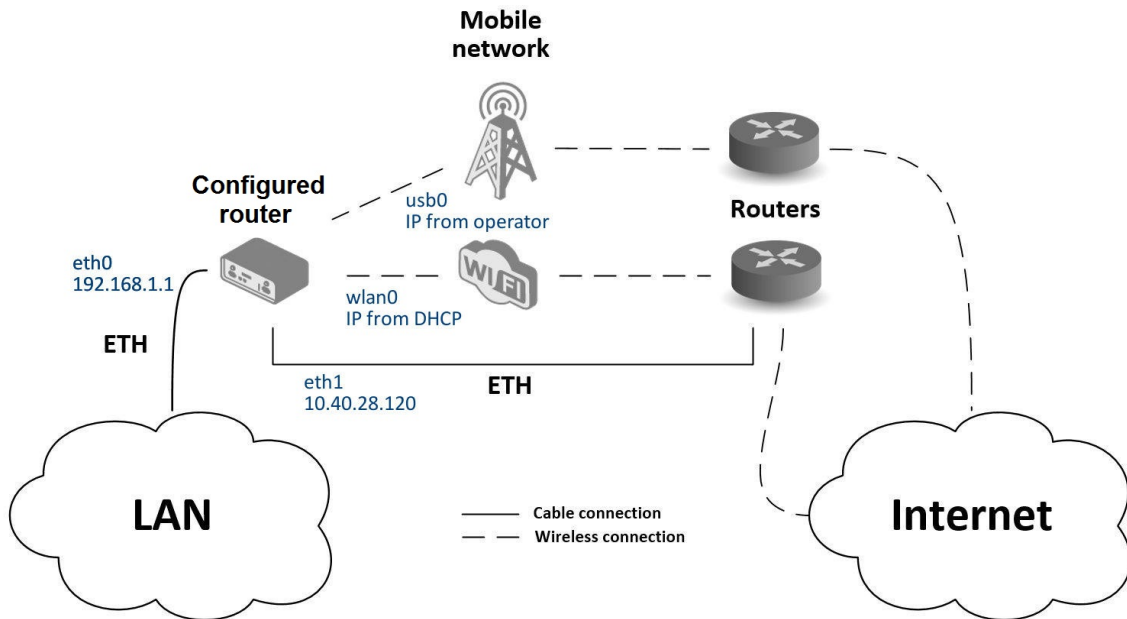

Figure 126: Backup access to the Internet – sample topology

The configuration form on the *Backup Routes* page lets you back up the primary connection with alternative connections to the Internet/mobile network. Each backup connection can be assigned a priority.

Status	ETH1 Configuration	
General	IPv4	IPv6
Mobile WAN	DHCP Client: disabled	DHCP Client: disabled
Network	IP Address: 10.40.28.120	
DHCP	Subnet Mask / Prefix: 255.255.252.0	
IPsec	Default Gateway: 10.40.30.1	
DynDNS	DNS Server: 192.168.2.27	
System Log	Bridged: no	
Configuration	Media Type: auto-negotiation	
Ethernet	<input type="checkbox"/> Enable dynamic DHCP leases	
• ETH0	IP Pool Start	
• ETH1	IP Pool End	
VRRP	Lease Time: 600	600 sec
Mobile WAN		
PPPoE		
Backup Routes		
Static Routes		
Firewall		

Figure 127: Backup access to the Internet – Ethernet configuration

Ethernet configuration: In the *Ethernet* → *ETH0* item, you can use the factory default configuration as in the previous situation. The *ETH1* interface on the front panel of the router is used for connection to the Internet. It can be configured in *ETH1* menu item. Connect the cable to the router and set the appropriate values as in Figure 127. You may configure the static IP address, default gateway and DNS server. Changes will take effect after you click on the *Apply* button. Detailed Ethernet configuration is described in Chapter 3.1.

WLAN configuration: To use the WLAN you will need to configure the WiFi station in the *WiFi -> Station* item, as shown in Figure 128. Check the *Enable WiFi STA*, enable the DHCP client and fill in the addresses of the default gateway and DNS server. Next, fill in the data for the connection (SSID, authentication, encryption, WPA PSK Type and password). For details see Chapter 3.9. Click the *Apply* button to confirm the changes.

To verify that the WiFi connection is successful, check the *WiFi* item in the *Status* section. If the connection is successful you should see the following message: *wpa_state=COMPLETED*.

Status	WiFi STA Configuration	
<ul style="list-style-type: none"> General Mobile WAN WiFi Network DHCP IPsec DynDNS System Log 	<input checked="" type="checkbox"/> Enable WiFi STA	
<ul style="list-style-type: none"> Configuration Ethernet VRRP Mobile WAN PPPoE WiFi <ul style="list-style-type: none"> • Access Point • Station Backup Routes Static Routes Firewall NAT OpenVPN IPsec GRE L2TP PPTP Services Expansion Port 1 Expansion Port 2 	DHCP Client	IPv4: enabled IPv6: enabled
	IP Address	
	Subnet Mask / Prefix	
	Default Gateway	192.168.3.1
	DNS Server	192.168.3.1
	SSID	WiFiNetwork
	Probe Hidden SSID	enabled
	Country Code *	
	Authentication	WPA2-PSK
	Encryption	AES
	WEP Key Type	ASCII
	WEP Default Key	1
	WEP Key 1	
	WEP Key 2	
	WEP Key 3	
	WEP Key 4	
	WPA PSK Type	ASCII passphrase
	WPA PSK	WiFiPassword

Figure 128: Backup access to the Internet – WiFi configuration

Mobile WAN configuration: To configure the mobile connection it should be sufficient to insert the SIM card into the *SIM1* slot and attach the antenna to the *ANT* connector. (Depending on the SIM card you are using).

To set up backup routes you will need to enable *Check Connection* in the *Mobile WAN* item. (See Figure 129.) Set the *Check connection* option to *enabled + bind* and fill in an IP address of the mobile operator’s DNS server or any other reliably available server and enter the time interval of the check. For detailed configuration, see Chapter 3.5.1.

Backup Routes configuration: After setting up the backup routes you will need to set their priorities. In Figure 130, the *ETH1* wired connection has the highest priority. If that connection fails, the second choice will be the WiFi *wlan0* network interface. The third choice will be the mobile connection – *usb0* network interface.

The backup routes system must be activated by checking the *Enable backup routes switching* item for each of the routes. Click the *Apply* button to confirm the changes. For detailed configuration see Chapter 3.10.

You can verify the configured network interfaces in the *Status* section in the *Network* item. You will see the active network interfaces: *eth0* (connection to LAN), *eth1* (wired connection to the Internet), *wlan0* (WiFi connection to the Internet) and *usb0* (mobile connection to the Internet). IP addresses and other data are included.

At the bottom of the page you will see the *Route Table* and corresponding changes if a wired connection fails or a cable is disconnected (the default route changes to *wlan0*). Similarly, if a WiFi connection is not available, the mobile connection will be used.

Backup routes work even if they are not activated in the *Backup Routes* item, but the router will use the factory defaults.

Status	1st Mobile WAN Configuration																																										
<ul style="list-style-type: none"> General Mobile WAN WiFi Network DHCP IPsec DynDNS System Log 	<input checked="" type="checkbox"/> Create connection to mobile network																																										
Configuration	<table border="1" style="width: 100%; border-collapse: collapse;"> <thead> <tr> <th></th> <th style="font-size: small;">1st SIM card</th> <th style="font-size: small;">2nd SIM card</th> </tr> </thead> <tbody> <tr> <td>APN *</td> <td><input type="text"/></td> <td><input type="text"/></td> </tr> <tr> <td>Username *</td> <td><input type="text"/></td> <td><input type="text"/></td> </tr> <tr> <td>Password *</td> <td><input type="text"/></td> <td><input type="text"/></td> </tr> <tr> <td>Authentication</td> <td>PAP or CHAP ▼</td> <td>PAP or CHAP ▼</td> </tr> <tr> <td>IP Mode</td> <td>IPv4 ▼</td> <td>IPv4 ▼</td> </tr> <tr> <td>IP Address *</td> <td><input type="text"/></td> <td><input type="text"/></td> </tr> <tr> <td>Dial Number *</td> <td><input type="text"/></td> <td><input type="text"/></td> </tr> <tr> <td>Operator *</td> <td><input type="text"/></td> <td><input type="text"/></td> </tr> <tr> <td>Network Type</td> <td>automatic selection ▼</td> <td>automatic selection ▼</td> </tr> <tr> <td>PIN *</td> <td><input type="text"/></td> <td><input type="text"/></td> </tr> <tr> <td>MRU</td> <td>1500</td> <td>1500</td> <td style="font-size: x-small;">bytes</td> </tr> <tr> <td>MTU</td> <td>1500</td> <td>1500</td> <td style="font-size: x-small;">bytes</td> </tr> </tbody> </table>			1st SIM card	2nd SIM card	APN *	<input type="text"/>	<input type="text"/>	Username *	<input type="text"/>	<input type="text"/>	Password *	<input type="text"/>	<input type="text"/>	Authentication	PAP or CHAP ▼	PAP or CHAP ▼	IP Mode	IPv4 ▼	IPv4 ▼	IP Address *	<input type="text"/>	<input type="text"/>	Dial Number *	<input type="text"/>	<input type="text"/>	Operator *	<input type="text"/>	<input type="text"/>	Network Type	automatic selection ▼	automatic selection ▼	PIN *	<input type="text"/>	<input type="text"/>	MRU	1500	1500	bytes	MTU	1500	1500	bytes
	1st SIM card	2nd SIM card																																									
APN *	<input type="text"/>	<input type="text"/>																																									
Username *	<input type="text"/>	<input type="text"/>																																									
Password *	<input type="text"/>	<input type="text"/>																																									
Authentication	PAP or CHAP ▼	PAP or CHAP ▼																																									
IP Mode	IPv4 ▼	IPv4 ▼																																									
IP Address *	<input type="text"/>	<input type="text"/>																																									
Dial Number *	<input type="text"/>	<input type="text"/>																																									
Operator *	<input type="text"/>	<input type="text"/>																																									
Network Type	automatic selection ▼	automatic selection ▼																																									
PIN *	<input type="text"/>	<input type="text"/>																																									
MRU	1500	1500	bytes																																								
MTU	1500	1500	bytes																																								
<ul style="list-style-type: none"> Ethernet VRRP Mobile WAN <ul style="list-style-type: none"> • 1st Module ← • 2nd Module • Module Switching PPPoE WiFi Backup Routes Static Routes Firewall NAT OpenVPN IPsec GRE L2TP PPTP Services USB Port Scripts Automatic Update 	<table border="1" style="width: 100%; border-collapse: collapse;"> <thead> <tr> <th colspan="3" style="font-size: x-small; color: red;">(The feature of check connection to mobile network is necessary for uninterrupted operation)</th> </tr> </thead> <tbody> <tr> <td>Check Connection</td> <td>enabled + bind ▼</td> <td>disabled ▼</td> </tr> <tr> <td>Ping IP Address</td> <td>8.8.8.8 ←</td> <td><input type="text"/></td> </tr> <tr> <td>Ping IPv6 Address</td> <td><input type="text"/></td> <td><input type="text"/></td> </tr> <tr> <td>Ping Interval</td> <td>60</td> <td>sec</td> </tr> <tr> <td>Ping Timeout</td> <td>10</td> <td>sec</td> </tr> </tbody> </table>		(The feature of check connection to mobile network is necessary for uninterrupted operation)			Check Connection	enabled + bind ▼	disabled ▼	Ping IP Address	8.8.8.8 ←	<input type="text"/>	Ping IPv6 Address	<input type="text"/>	<input type="text"/>	Ping Interval	60	sec	Ping Timeout	10	sec																							
(The feature of check connection to mobile network is necessary for uninterrupted operation)																																											
Check Connection	enabled + bind ▼	disabled ▼																																									
Ping IP Address	8.8.8.8 ←	<input type="text"/>																																									
Ping IPv6 Address	<input type="text"/>	<input type="text"/>																																									
Ping Interval	60	sec																																									
Ping Timeout	10	sec																																									
Customization																																											

Figure 129: Backup access to the Internet – Mobile WAN configuration

Status	Backup Routes Configuration
General	<input checked="" type="checkbox"/> Enable backup routes switching
Mobile WAN	Mode <input type="text" value="Single WAN"/>
WiFi	<input checked="" type="checkbox"/> Enable backup routes switching for Mobile WAN
Network	Priority <input type="text" value="3rd"/>
DHCP	Weight <input type="text"/>
IPsec	<input type="checkbox"/> Enable backup routes switching for PPPoE
DynDNS	Priority <input type="text" value="1st"/>
System Log	Ping IP Address <input type="text"/>
Configuration	
Ethernet	Ping IPv6 Address <input type="text"/>
VRRP	Ping Interval <input type="text"/> sec
Mobile WAN	Ping Timeout <input type="text" value="10"/> sec
PPPoE	Weight <input type="text"/>
WiFi	<input checked="" type="checkbox"/> Enable backup routes switching for WiFi STA
Backup Routes	Priority <input type="text" value="2nd"/>
Static Routes	Ping IP Address <input type="text"/>
Firewall	Ping IPv6 Address <input type="text"/>
NAT	Ping Interval <input type="text"/> sec
OpenVPN	Ping Timeout <input type="text" value="10"/> sec
IPsec	Weight <input type="text"/>
GRE	<input type="checkbox"/> Enable backup routes switching for ETH0
L2TP	Priority <input type="text" value="1st"/>
PPTP	Ping IP Address <input type="text"/>
Services	Ping IPv6 Address <input type="text"/>
Expansion Port	Ping Interval <input type="text"/> sec
Scripts	Ping Timeout <input type="text" value="10"/> sec
Automatic Update	Weight <input type="text"/>
Customization	
User Modules	<input checked="" type="checkbox"/> Enable backup routes switching for ETH1
Administration	
Users	Priority <input type="text" value="1st"/>
Change Profile	Ping IP Address <input type="text"/>
Change Password	Ping IPv6 Address <input type="text"/>
Set Real Time Clock	Ping Interval <input type="text"/> sec
Set SMS Service Center	Ping Timeout <input type="text" value="10"/> sec
Unlock SIM Card	Weight <input type="text"/>
Unblock SIM Card	
Send SMS	
Backup Configuration	
Restore Configuration	
Update Firmware	
Reboot	
Logout	
	<input type="button" value="Apply"/>

Figure 130: Backup access to the Internet – Backup Routes configuration

6.3 Secure Networks Interconnection or Using VPN

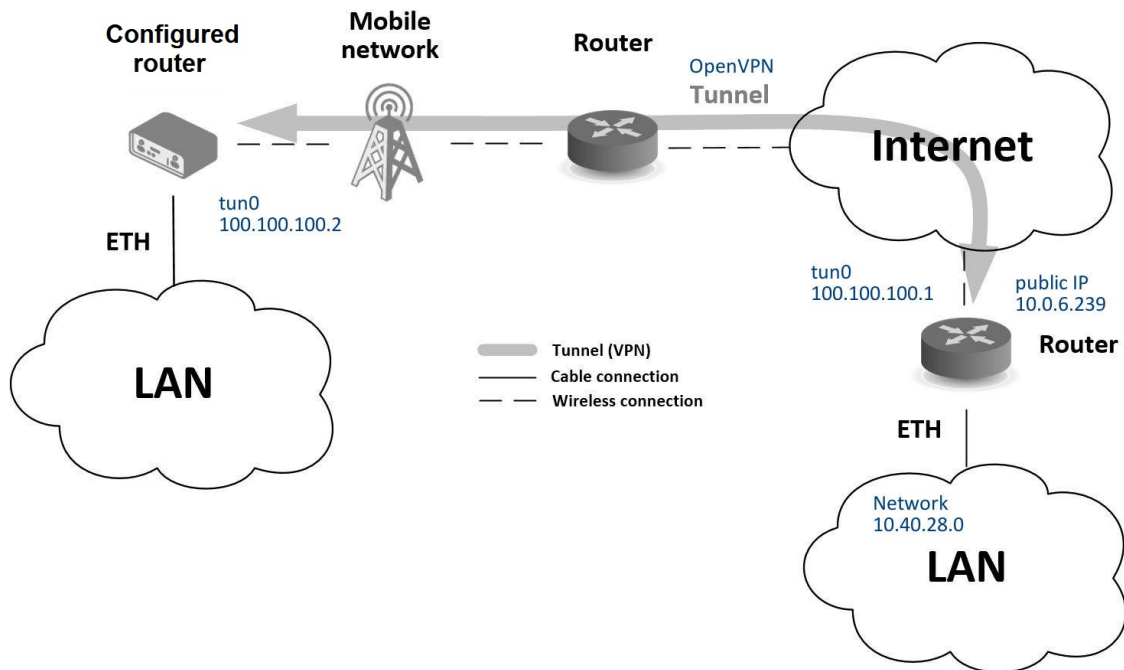

Figure 131: Secure Networks Interconnection – Sample Topology

VPN (Virtual Private Network) is a protocol used to create a secure connection between two LANs, allowing them to function as a single network. The connection is secured (encrypted) and authenticated (verified). It is used over public, untrusted networks, see fig. 131. You may use several different secure protocols.

- *OpenVPN* (it is a configuration item in the web interface of the router), see Chapter 3.14 or Application Note [5],
- *IPsec* (it is also configuration item in the web interface of the router), see Chapter 3.15 or Application Note [6].

You can also create non-encrypted tunnels: *GRE*, *PPTP* and *L2TP*. You can use GRE or L2TP tunnel in combination with IPsec to create VPNs.

There is an example of an OpenVPN tunnel in Figure 131. To establish this tunnel you will need the opposite router's IP address, the opposite router's network IP address (not necessary) and the pre-shared secret (key). Create the OpenVPN tunnel by configuring the *Mobile WAN* and *OpenVPN* items in the *Configuration* section.

Mobile WAN configuration: The mobile connection can be configured as described in the previous situations. (The router connects itself after a SIM card is inserted into *SIM1* slot and an antenna is attached to the *ANT* connector.)

Configuration is accessible via the *Mobile WAN* item the *Configuration* section, see Chapter 3.5.1). The mobile connection has to be enabled.

OpenVPN configuration: OpenVPN configuration is done with the *OpenVPN* item in the *Configuration* section. Choose one of the two possible tunnels and enable it by checking the *Create 1st OpenVPN tunnel*. You will need to fill in the protocol and the port (according to the settings on the opposite side of the tunnel or Open VPN server). You may fill in the public IP address of the opposite side of the tunnel including the remote subnet and mask (not necessary). The important items are *Local* and *Remote Interface IP Address* where the information regarding the interfaces of the tunnel's end must be filled in. In the example shown, the *pre-shared secret* is known, so you would choose this option in the *Authentication Mode* item and insert the secret (key) into the field. For detailed configuration see Chapter 3.14 or Application Note [5].

Status	1st OpenVPN Tunnel Configuration
General	<input checked="" type="checkbox"/> Create 1st OpenVPN tunnel
Mobile WAN	Description * <input type="text" value="myTunnel"/>
WiFi	Interface Type <input type="text" value="TUN"/>
Network	Protocol <input type="text" value="UDP"/>
DHCP	UDP Port <input type="text" value="3000"/>
IPsec	Remote IP Address * <input type="text" value="10.0.6.239"/>
DynDNS	Remote Subnet * <input type="text" value="10.40.28.0"/>
System Log	Remote Subnet Mask * <input type="text" value="255.255.252.0"/>
	Redirect Gateway <input type="text" value="no"/>
	Local Interface IP Address <input type="text" value="100.100.100.2"/>
	Remote Interface IP Address <input type="text" value="100.100.100.1"/>
	Remote IPv6 Subnet * <input type="text"/>
	Remote IPv6 Subnet Prefix Length * <input type="text"/>
	Local Interface IPv6 Address * <input type="text"/>
	Remote Interface IPv6 Address * <input type="text"/>
	Ping Interval * <input type="text" value="10"/> sec
	Ping Timeout * <input type="text" value="30"/> sec
	Renegotiate Interval * <input type="text"/> sec
	Max Fragment Size * <input type="text"/> bytes
	Compression <input type="text" value="LZO"/>
	NAT Rules <input type="text" value="not applied"/>
	Authenticate Mode <input type="text" value="pre-shared secret"/>
	Security Mode <input type="text" value="tls-auth"/>
	Pre-shared Secret <pre># # 2048 OpenVPN static key #</pre>

Configuration

- Ethernet
- VRRP
- Mobile WAN
- PPPoE
- WiFi
- Backup Routes
- Static Routes
- Firewall
- NAT
- OpenVPN
 - 1st Tunnel** ←
 - 2nd Tunnel
 - 3rd Tunnel
 - 4th Tunnel
- IPsec
- GRE
- L2TP
- PPTP
- Services
- Expansion Port
- Scripts
- Automatic Update

Figure 132: Secure Networks Interconnection – OpenVPN Configuration

The *Network* item in the *Status* section will let you verify the activated network interface `tun0` for the tunnel with the IP addresses of the tunnel's ends set. Successful connection can be verified in the *System Log* where you should see the message: Initialization Sequence Completed. The networks are now interconnected. This can also be verified by using the ping program. (Ping between tunnel's endpoint IP addresses from one of the routers. The console is accessible via SSH).

Appendix A: Open Source Software License

The software in this device includes various open-source components governed by the following licenses:

- GPL versions 2 and 3
- LGPL version 2
- BSD-style licenses
- MIT-style licenses

A complete list of components and their respective license texts can be found directly on the device. To access them, click the *Licenses* link at the bottom of the router's main web page (*General Status*) or navigate to the following URL in your browser (replace `DEVICE_IP` with the actual router's IP address):

https://DEVICE_IP/licenses.cgi

This serves as a written offer, valid for three years from the date of purchase, to provide any third party with a complete machine-readable copy of the corresponding source code on a flash drive medium for a fee no greater than the cost of physically performing the source distribution. If you wish to obtain the source code, please contact us at:

iiotcustomerservice@advantech.eu

Modifications and debugging of LGPL-linked executables:

The device manufacturer grants customers the right to use debugging techniques (e.g., decompilation) and modify any executable linked with an LGPL library for their own use. These rights are strictly limited to personal usage—redistribution of modified executables or sharing information obtained through these actions is not permitted.

Source code under the GPL license is available at:

icr.advantech.com/source-code

Appendix B: Glossary and Acronyms

B | D | G | H | I | L | N | O | P | R | S | T | U | V | W | X

B

Backup Routes Allows user to back up the primary connection with alternative connections to the Internet/mobile network. Each backup connection can have assigned a priority. Switching between connections is done based upon set priorities and the state of the connections.

D

DHCP The Dynamic Host Configuration Protocol (DHCP) is a network protocol used to configure devices that are connected to a network so they can communicate on that network using the Internet Protocol (IP). The protocol is implemented in a client-server model, in which DHCP clients request configuration data, such as an IP address, a default route, and one or more DNS server addresses from a DHCP server.

DHCP client Requests network configuration from DHCP server.

DHCP server Answers configuration request by DHCP clients and sends network configuration details.

DNS The Domain Name System (DNS) is a hierarchical distributed naming system for computers, services, or any resource connected to the Internet or a private network. It associates various information with domain names assigned to each of the participating entities. Most prominently, it translates easily memorized domain names to the numerical IP addresses needed for the purpose of locating computer services and devices worldwide. By providing a worldwide, distributed keyword-based redirection service, the Domain Name System is an essential component of the functionality of the Internet.

DynDNS client DynDNS service lets you access the router remotely using an easy to remember custom hostname. This client monitors the router's IP address and updates it whenever it changes.

G

GRE Generic Routing Encapsulation (GRE) is a tunneling protocol that can encapsulate a wide variety of network layer protocols inside virtual point-to-point links over an Internet Protocol network. It is possible to create four different tunnels.

H

HTTP The Hypertext Transfer Protocol (HTTP) is an application protocol for distributed, collaborative, hypermedia information systems. HTTP is the foundation of data communication for the World Wide Web.

Hypertext is structured text that uses logical links (hyperlinks) between nodes containing text. HTTP is the protocol to exchange or transfer hypertext.

HTTPS The Hypertext Transfer Protocol Secure (HTTPS) is a communications protocol for secure communication over a computer network, with especially wide deployment on the Internet. Technically, it is not a protocol in and of itself; rather, it is the result of simply layering the Hypertext Transfer Protocol (HTTP) on top of the SSL/TLS protocol, thus adding the security capabilities of SSL/TLS to standard HTTP communications.

I

IP address An Internet Protocol address (IP address) is a numerical label assigned to each device (e.g., computer, printer) participating in a computer network that uses the Internet Protocol for communication. An IP address serves two principal functions: host or network interface identification and location addressing. Its role has been characterized as follows: *A name indicates what we seek. An*

address indicates where it is. A route indicates how to get there

The designers of the Internet Protocol defined an IP address as a 32-bit number and this system, known as Internet Protocol Version 4 (IPv4), is still in use today. However, due to the enormous growth of the Internet and the predicted depletion of available addresses, a new version of IP (IPv6), using 128 bits for the address, was developed in 1995.

IP masquerade Kind of NAT.

IP masquerading see NAT.

IPsec Internet Protocol Security (IPsec) is a protocol suite for securing Internet Protocol (IP) communications by authenticating and encrypting each IP packet of a communication session. The router allows user to select encapsulation mode (tunnel or transport), IKE mode (main or aggressive), IKE Algorithm, IKE Encryption, ESP Algorithm, ESP Encryption and much more. It is possible to create four different tunnels.

IPv4 The Internet Protocol version 4 (IPv4) is the fourth version in the development of the Internet Protocol (IP) and the first version of the protocol to be widely deployed. It is one of the core protocols of standards-based internetworking methods of the Internet, and routes most traffic in the Internet. However, a successor protocol, IPv6, has been defined and is in various stages of production deployment. IPv4 is described in IETF publication RFC 791 (September 1981), replacing an earlier definition (RFC 760, January 1980).

IPv6 The Internet Protocol version 6 (IPv6) is the latest revision of the Internet Protocol (IP), the communications protocol that provides an identification and location system for computers on networks and routes traffic across the Internet. IPv6 was developed by the Internet Engineering Task Force (IETF) to deal with the long-anticipated problem of IPv4 address exhaustion.

IPv6 is intended to replace IPv4, which still carries the vast majority of Internet traffic as of 2013. As of late November 2012, IPv6 traffic share was reported to be approaching 1%.

IPv6 addresses are represented as eight groups of four hexadecimal digits separated by colons (2001:0db8:85a3:0042:1000:8a2e:0370:7334), but methods of abbreviation of this full notation exist.

L

L2TP Layer 2 Tunneling Protocol (L2TP) is a tunnelling protocol used to support virtual private networks (VPNs) or as part of the delivery of services by ISPs. It does not provide any encryption or confidentiality by itself. Rather, it relies on an encryption protocol that it passes within the tunnel to provide privacy.

LAN A local area network (LAN) is a computer network that interconnects computers in a limited area such as a home, school, computer laboratory, or office building using network media. The defining characteristics of LANs, in contrast to wide area networks (WANs), include their usually higher data-transfer rates, smaller geographic area, and lack of a need for leased telecommunication lines.

N

NAT In computer networking, Network Address Translation (NAT) is the process of modifying IP address information in IPv4 headers while in transit across a traffic routing device.

The simplest type of NAT provides a one-to-one translation of IP addresses. RFC 2663 refers to this type of NAT as basic NAT, which is often also called a one-to-one NAT. In this type of NAT only the IP addresses, IP header checksum and any higher level checksums that include the IP address are changed. The rest of the packet is left untouched (at least for basic TCP/UDP functionality; some higher level protocols may need further translation). Basic NATs can be used to interconnect two IP networks that have incompatible addressing.

NAT-T NAT traversal (NAT-T) is a computer networking methodology with the goal to establish and maintain Internet protocol connections across gateways that implement network address translation (NAT).

NTP Network Time Protocol (NTP) is a networking protocol for clock synchronization between computer systems over packet-switched, variable-latency data networks.

O

OpenVPN OpenVPN implements virtual private network (VPN) techniques for creating secure point-to-point or site-to-site connections. It is possible to create four different tunnels.

P

PAT Port and Address Translation (PAT) or Network Address Port Translation (NAPT) see NAT.

Port In computer networking, a Port is an application-specific or process-specific software construct serving as a communications endpoint in a computer's host operating system. A port is associated with an IP address of the host, as well as the type of protocol used for communication. The purpose of ports is to uniquely identify different applications or processes running on a single computer and thereby enable them to share a single physical connection to a packet-switched network like the Internet.

PPTP The Point-to-Point Tunneling Protocol (PPTP) is a tunneling protocol that operates at the Data Link Layer (Layer 2) of the OSI Reference Model. PPTP is a proprietary technique that encapsulates Point-to-Point Protocol (PPP) frames in Internet Protocol (IP) packets using the Generic Routing Encapsulation (GRE) protocol. Packet filters provide access control, end-to-end and server-to-server.

R

RADIUS Remote Authentication Dial-In User Service (RADIUS) is a networking protocol that provides centralized Authentication, Authorization, and Accounting (AAA or Triple A) management for users who connect and use a network service. Because of the broad support and the ubiquitous nature of the RADIUS protocol, it is often used by ISPs and enterprises to manage access to the Internet or internal networks, wireless networks, and integrated e-mail services.

Root certificate In cryptography and computer security, a root certificate is either an unsigned public key certificate or a self-signed certificate that identifies the Root Certificate Authority (CA). A root certificate is part of a public key infrastructure scheme. The most common commer-

cial variety is based on the ITU-T X.509 standard, which normally includes a digital signature from a certificate authority (CA).

Digital certificates are verified using a chain of trust. The trust anchor for the digital certificate is the Root Certificate Authority (CA). See X.509.

Router A router is a device that forwards data packets between computer networks, creating an overlay internetwork. A router is connected to two or more data lines from different networks. When a data packet comes in one of the lines, the router reads the address information in the packet to determine its ultimate destination. Then, using information in its routing table or routing policy, it directs the packet to the next network on its journey. Routers perform the *traffic directing* functions on the Internet. A data packet is typically forwarded from one router to another through the networks that constitute the internetwork until it reaches its destination node.

S

SFTP Secure File Transfer Protocol (SFTP) is a secure version of File Transfer Protocol (FTP), which facilitates data access and data transfer over a Secure Shell (SSH) data stream. It is part of the SSH Protocol. This term is also known as SSH File Transfer Protocol.

SMTP The SMTP (Simple Mail Transfer Protocol) is a standard e-mail protocol on the Internet and part of the TCP/IP protocol suite, as defined by IETF RFC 2821. SMTP defines the message format and the message transfer agent (MTA), which stores and forwards the mail. SMTP by default uses TCP port 25. The protocol for mail submission is the same, but uses port 587. SMTP connections secured by SSL, known as SMTPS, default to port 465.

SMTPS SMTPS (Simple Mail Transfer Protocol Secure) refers to a method for securing SMTP with transport layer security. For more information about SMTP, see description of the SMTP.

SNMP The Simple Network Management Protocol (SNMP) is an *Internet-standard protocol for managing devices on IP networks*. Devices that typically support SNMP include routers, switches, servers, workstations, printers, modem racks, and more. It is used mostly

in network management systems to monitor network-attached devices for conditions that warrant administrative attention. SNMP is a component of the Internet Protocol Suite as defined by the Internet Engineering Task Force (IETF). It consists of a set of standards for network management, including an application layer protocol, a database schema, and a set of data objects.

SSH Secure Shell (SSH), sometimes known as Secure Socket Shell, is a UNIX-based command interface and protocol for securely getting access to a remote computer. It is widely used by network administrators to control Web and other kinds of servers remotely. SSH is actually a suite of three utilities – `slogin`, `ssh`, and `scp` – that are secure versions of the earlier UNIX utilities, `rlogin`, `rsh`, and `rcp`. SSH commands are encrypted and secure in several ways. Both ends of the client/server connection are authenticated using a digital certificate, and passwords are protected by being encrypted.

T

TCP The Transmission Control Protocol (TCP) is one of the core protocols of the Internet protocol suite (IP), and is so common that the entire suite is often called TCP/IP. TCP provides reliable, ordered, error-checked delivery of a stream of octets between programs running on computers connected to a local area network, intranet or the public Internet. It resides at the transport layer.

Web browsers use TCP when they connect to servers on the World Wide Web, and it is used to deliver email and transfer files from one location to another.

U

UDP The User Datagram Protocol (UDP) is one of the core members of the Internet protocol suite (the set of network protocols used for the Internet). With UDP, computer applications can send messages, in this case referred to as datagrams, to other hosts on an Internet Protocol (IP) network without prior communications

to set up special transmission channels or data paths. The protocol was designed by David P. Reed in 1980 and formally defined in RFC 768.

URL A uniform resource locator, abbreviated URL, also known as web address, is a specific character string that constitutes a reference to a resource. In most web browsers, the URL of a web page is displayed on top inside an address bar. An example of a typical URL would be <http://www.example.com/index.html>, which indicates a protocol (`http`), a hostname (`www.example.com`), and a file name (`index.html`). A URL is technically a type of uniform resource identifier (URI), but in many technical documents and verbal discussions, URL is often used as a synonym for URI, and this is not considered a problem.

V

VPN A virtual private network (VPN) extends a private network across a public network, such as the Internet. It enables a computer to send and receive data across shared or public networks as if it were directly connected to the private network, while benefiting from the functionality, security and management policies of the private network. This is done by establishing a virtual point-to-point connection through the use of dedicated connections, encryption, or a combination of the two.

A VPN connection across the Internet is similar to a wide area network (WAN) link between the sites. From a user perspective, the extended network resources are accessed in the same way as resources available from the private network.

VPN server see VPN.

VPN tunnel see VPN.

VRRP VRRP protocol (Virtual Router Redundancy Protocol) allows you to transfer packet routing from the main router to a backup router in case the main router fails. (This can be used to provide a wireless cellular backup to a primary wired router in critical applications).

W

WAN A wide area network (WAN) is a network that covers a broad area (i.e., any telecommuni-

cations network that links across metropolitan, regional, or national boundaries) using private or public network transports. Business and government entities utilize WANs to relay data among employees, clients, buyers, and suppliers from various geographical locations. In essence, this mode of telecommunication allows a business to effectively carry out its daily function regardless of location. The Internet can be considered a WAN as well, and is used by businesses, governments, organizations, and individuals for almost any purpose imaginable.

WebAccess/DMP WebAccess/DMP is an advanced Enterprise-Grade platform solution for provisioning, monitoring, managing and configuring Advantech's routers and IoT gateways. It provides a zero-touch enablement platform for each remote device.

WebAccess/VPN WebAccess/VPN is an advanced VPN management solution for safe interconnection of Advantech routers and LAN networks in public Internet. Connection among devices and networks can be regional or global and can combine different technology platforms and various wireless, LTE, fixed and satellite connectivities.

X

X.509 In cryptography, X.509 is an ITU-T standard for a public key infrastructure (PKI) and Privilege Management Infrastructure (PMI). X.509 specifies, amongst other things, standard formats for public key certificates, certificate revocation lists, attribute certificates, and a certification path validation algorithm.

Appendix C: Index

A

Access Point	
Configuration	60
Information	16
Accessing the router	2
Add User	157
APN	46
AT commands	135
Authentication	119

B

Backup Configuration	171
Backup Routes	70
Bridge	30

C

Change Profile	166
Configuration update	150
Control SMS messages	134

D

Data limit	49
Default Gateway	29, 67
Default IP address	2
Default Module	56
Default password	3
Default SIM card	51
Default username	3
DHCP	23, 29, 67, 184
DHCPv6	31
Dynamic	31
Static	31
DHCPv6	23, 29, 67
DNS	184
DNS server	29, 47, 67
DNS64	20
Domain Name System	<i>see</i> DNS
DoS attacks	85
Dynamic Host Configuration Protocol	<i>see</i> DHCP
DynDNS	26, 123
DynDNSv6	26, 123

F

Firewall	83
Filtering of Forwarded Packets	84
Filtering of Incoming Packets	84
Protection against DoS attacks	85
Firmware update	150, 173
Firmware version	11
First-Time Login to the Admin Web Interface	3
FTP	124

G

GRE	110, 184
-----	----------

H

HTTP	125
------	-----

I

ICMPv6	47
IPsec	98, 185
Authenticate Mode	103
Encapsulation Mode	102
IKE Mode	102
IPv4	185
IPv6	8, 20, 28, 32, 46, 47, 83, 88, 93, 98, 123, 149

L

L2TP	113, 185
LAN	
ETH0	28
ETH1	28
IPv6	28
PoE PSE	30
Location Area Code	12
Logout	174

M

Mobile network	<i>see</i> DHCP 45
Modify User	159
Multiple WANs	70, 72, 82

N

NAT	88, 185
NAT64	20
Neighbouring WiFi Networks	17
Network Address Translation	see NAT
NTP	126, 185
NTP server	167

O

Object Identifier	128
OpenVPN	93, 186
Authenticate Mode	94

P

PAT	88
PIN number	168
PLMN	12
PoE PSE	9, 30
Port	186
PPPoE	58
PPPoE Bridge Mode	57
PPTP	116, 186
Prefix delegation	32
PUK number	169

R

RADIUS	34, 60, 63
Reboot	174
Remote access	89
Restore Configuration	172
Router	1
Accessing	2
Router Apps	154

S

Save Log	27
Save Report	27
Send SMS	170
Serial number	11
Set internal clock	167
Signal Quality	12
Simple Network Management Protocol	see SNMP
SMS	132
SMS Service Center	168

SMTP	131, 186
SNMP	127, 186
SSH	140
Startup Script	148
Static Routes	82
Switch between modules	55
Switch between SIM Cards	50
Syslog	141
System Log	27

T

TCP	187
Telnet	144
Transmission Control Protocol	see TCP
Two-Factor Authentication	160

U

UDP	187
Unblock SIM card	169
Uniform resource locator	see URL
Unlock SIM card	168
Up/Down script	149
URL	187
Usage Profiles	166
USB	
USB/RS232 converters	146
USB Port	145
User Datagram Protocol	see UDP
Users	157

V

Virtual private network	see VPN
VLAN	41
VPN	187
VRRP	43, 187

W

WiFi	
Authentication	62, 68
HW Mode	61
WiFi AP	60
WiFi STA	66
WiFi Station	
Configuration	66
WireGuard	106

Appendix D: Related Documents

- [1] Command Line Interface
- [2] Remote Monitoring
- [3] WebAccess/DMP
- [4] R-SeeNet
- [5] OpenVPN Tunnel
- [6] IPsec Tunnel
- [7] GRE Tunnel
- [8] WireGuard Tunnel
- [9] FlexVPN
- [10] VLAN
- [11] SNMP Object Identifiers
- [12] AT Commands (AT-SMS)
- [13] Quality of Service (QoS)
- [14] Programming of Router Apps
- [15] Security Guidelines



[EP] Product-related documents and applications can be obtained on **Engineering Portal** at <https://icr.advantech.com/download> address.



[RA] **Router Apps** (formerly *User modules*) and related documents can be obtained on *Engineering Portal* at <https://icr.advantech.com/products/router-apps> address.