

# Configuration Manual

## SmartStart Family



© 2026 Advantech Czech s.r.o. No part of this publication may be reproduced or transmitted in any form or by any means, electronic or mechanical, including photography, recording, or any information storage and retrieval system, without prior written consent. Information in this manual is subject to change without notice and does not represent a commitment by Advantech.

Advantech Czech s.r.o. shall not be liable for any incidental or consequential damages arising from the use, performance, or furnishing of this manual.

All brand names used in this manual are registered trademarks of their respective owners. The use of trademarks or other designations in this publication is for reference purposes only and does not imply endorsement by the trademark holder.

# Used symbols

## Important



**Important** — Indicates a risk to personal safety or potential damage to the router. Follow these instructions precisely to prevent injury or equipment damage.

## Warning



**Warning** — Highlights conditions that may cause malfunction, loss of data, or unexpected behavior in specific situations. Read carefully before proceeding.

## Info



**Info** — Provides helpful tips, context, or references that improve understanding but are not strictly required to complete the task.

# Firmware Version

This manual applies to firmware version **6.6.1 (April 24, 2026)**. Features introduced after this version may not be covered.

# Contents

<b>1. Getting Started</b>	<b>1</b>
1.1 Document Contents	1
1.2 Configuration Environments	2
1.2.1 Web Interface Initial Setup	3
1.2.2 Remote Management Platform	5
1.3 Device	6
1.3.1 Persistent Storage	6
1.3.2 Reset Procedures	6
<b>2. Status</b>	<b>7</b>
2.1 General	7
2.2 Mobile WAN	10
2.3 Wi-Fi	13
2.3.1 Status	13
2.3.2 Scan	18
2.4 Network	19
2.5 DHCP	23
2.6 IPsec	24
2.7 WireGuard	25
2.8 Dynamic DNS	26
2.9 Connections	27
2.10 Router Apps	28
2.11 System Log	29
<b>3. Configuration</b>	<b>30</b>
3.1 Ethernet	30
3.2 VLAN	43
3.3 VRRP	45
3.4 Mobile WAN	48
3.5 PPPoE	58
3.6 WiFi	60
3.6.1 Access Point	60
3.6.2 Station	65
3.6.3 Country	68
3.7 Backup Routes	69
3.8 Static Routes	78
3.9 Firewall	79
3.9.1 Sites	83
3.10 NAT	84
3.11 OpenVPN	89
3.12 IPsec	93
3.13 WireGuard	102
3.14 VXLAN	106
3.15 GRE	108
3.16 L2TP	110
3.17 PPTP	112
3.18 Services	114
3.18.1 Dynamic DNS	114
3.18.2 FTP	116
3.18.3 HTTP	117

3.18.4	LLDP	119
3.18.5	NTP	120
3.18.6	SMTP	122
3.18.7	SMS	123
3.18.8	SNMP	131
3.18.9	SSH	135
3.18.10	Syslog	137
3.18.11	Telnet	140
3.19	Peripheral Ports	141
3.19.1	RS-232 Port	141
3.19.2	Inputs/Outputs	145
3.20	System	146
3.20.1	Authentication	146
3.20.2	Identification	150
3.20.3	Automatic Update	151
3.21	Events	155
3.22	Scripts	158
3.22.1	Startup	158
3.22.2	Up/Down IPv4	159
3.22.3	Up/Down IPv6	159
3.23	Scripts	160
3.23.1	Startup	160
3.23.2	Up/Down IPv4	161
3.23.3	Up/Down IPv6	161
3.24	Quick Setup	162
<b>4.</b>	<b>Customization</b>	<b>165</b>
4.1	Router Apps	165
4.2	Settings	167
<b>5.</b>	<b>Administration</b>	<b>168</b>
5.1	Manage Users	168
5.2	Modify User	174
5.3	Change Profile	175
5.4	Set Date and Time	176
5.5	Manage SIM	177
5.5.1	Unlock SIM	177
5.5.2	Unblock SIM	178
5.5.3	Set SMS Center	179
5.5.4	Switch SIM	180
5.6	Send SMS	181
5.7	Backup Configuration	182
5.8	Restore Configuration	183
5.8.1	Restore from File	183
5.8.2	Factory Reset	184
5.9	Update Firmware	185
5.10	Reboot	187
5.10.1	Reboot Now	187
5.10.2	Reboot Schedule	188
5.11	Logout	189
<b>6.</b>	<b>Typical Use Cases</b>	<b>190</b>
6.1	Access to the Internet from LAN	190
6.2	Backup Access to the internet from LAN	192

6.3	Secure Network Interconnection with VPN	195
6.4	Serial Gateway	198
<b>Appendix A: Open Source Software License</b>		<b>200</b>
<b>Appendix B: Glossary and Acronyms</b>		<b>201</b>
<b>Appendix C: Index</b>		<b>205</b>
<b>Appendix D: Related Documents</b>		<b>208</b>

# List of Figures

1	Web GUI layout overview	4
2	Mobile WAN status page	10
3	Wi-Fi AP status page	13
4	Wi-Fi STA status page	16
5	Wi-Fi scan results	18
6	Network status page overview	19
7	DHCP status page	23
8	IPsec status	24
9	WireGuard status page	25
10	Dynamic DNS status page	26
11	List of active network connections	27
12	Router Apps status page	28
13	System log page	29
14	LAN configuration page	30
15	LAN configuration page	31
16	Example of an IPv6 address with prefix	34
17	IEEE 802.1X functional diagram	35
18	Network topology for example 1	37
19	LAN configuration for example 1	38
20	Network topology for example 2	39
21	LAN configuration for example 2	40
22	Network topology for example 3	41
23	LAN configuration for example 3	42
24	VLAN configuration page	43
25	VRRP configuration page	45
26	An example of VRRP topology	47
27	Main router configuration	47
28	Mobile WAN configuration page – part 1	48
29	Mobile WAN configuration page – part 2	49
30	Connection check example	53
31	Configuration for SIM card switching example 1	57
32	Configuration for SIM card switching example 2	57
33	PPPoE configuration page	58
34	Wi-Fi access point configuration page	64
35	Wi-Fi station configuration page	67
36	Backup routes configuration page	70
37	GUI configuration for example 1	72
38	Network topology for example 1	72
39	GUI configuration for example 2	73
40	Network topology for example 2	73
41	GUI configuration for example 3	74
42	Single WAN mode topology for example 3	75
43	Multiple WANs mode topology for example 3	75
44	GUI configuration for example 4	76
45	Network topology for example 4	76
46	GUI configuration for example 5	77
47	Network topology for example 5	77
48	Static routes configuration page	78
49	IPv4 default firewall configuration	79
50	IPv4 firewall configuration topology example	82
51	IPv4 firewall configuration example	82

52	Firewall sites configuration page	83
53	NAT IPv4 configuration page	84
54	Topology for NAT example 1	87
55	NAT configuration for example 1	87
56	Topology for NAT example 2	88
57	NAT configuration for example 2	88
58	OpenVPN tunnel configuration page	89
59	An example of OpenVPN topology	92
60	IPsec tunnels configuration page – part 1	96
61	IPsec tunnels configuration page – part 2	97
62	IPsec configuration topology example	101
63	WireGuard tunnel configuration page	102
64	An example of WireGuard topology	104
65	Router A: WireGuard status and route table	105
66	Router B: WireGuard status and route table	105
67	VXLAN configuration page	106
68	GRE tunnel configuration page	108
69	An example of GRE topology	109
70	L2TP tunnel configuration page	110
71	An example of L2TP topology	111
72	PPTP tunnel configuration page	112
73	An example of PPTP topology	113
74	Configuration of FTP server	116
75	Web server configuration page	117
76	LLDP configuration page	119
77	NTP configuration page	120
78	SMTP client configuration example	122
79	SMS Configuration for example 1	127
80	SMS Configuration for example 2	128
81	SMS Configuration for example 3	129
82	SMS Configuration for example 4	130
83	SNMP configuration page	132
84	OID basic structure	133
85	MIB browser example	134
86	SSH server configuration page	135
87	Syslog configuration page	137
88	Telnet server configuration page	140
89	RS-232 serial port configuration	141
90	Ethernet-to-serial communication configuration example	143
91	Serial interface configuration example	144
92	Inputs/Outputs configuration example	145
93	Authentication configuration page	146
94	RADIUS configuration	148
95	TACACS+ configuration	149
96	Identification configuration page	150
97	Automatic Update configuration page	151
98	Example of a scheduled automatic update	153
99	Example of an automatic update using the MAC address	154
100	Events configuration page	155
101	IPv6 up/down script configuration page	159
102	IPv6 up/down script configuration page	161
103	Quick Setup page	162
104	Default Router Apps page	165
105	Router Apps page with online apps loaded	166
106	Router Apps server settings	167

107	Manage Users configuration page . . . . .	168
108	Generating an RSA key pair with PuTTYgen . . . . .	172
109	Forced password change prompt . . . . .	173
110	Modify User configuration page . . . . .	174
111	Change profile page . . . . .	175
112	Set date and time page . . . . .	176
113	Unlock SIM page . . . . .	177
114	Unblock SIM page . . . . .	178
115	Set SMS service center page . . . . .	179
116	Switch SIM page . . . . .	180
117	Send SMS dialog . . . . .	181
118	Backup configuration page . . . . .	182
119	Restore from file page . . . . .	183
120	Factory reset page . . . . .	184
121	Update firmware administration page . . . . .	185
122	Firmware update in progress . . . . .	186
123	Reboot Now Submenu . . . . .	187
124	Reboot schedule submenu . . . . .	188
125	Access to the Internet from LAN – sample topology . . . . .	190
126	Access to the Internet from LAN – Ethernet configuration . . . . .	191
127	Access to the Internet from LAN – mobile WAN configuration . . . . .	191
128	Backup access to the internet – sample topology . . . . .	192
129	Backup access to the internet – WiFi configuration . . . . .	193
130	Backup access to the internet – mobile WAN configuration . . . . .	194
131	Backup access to the internet – backup routes configuration . . . . .	194
132	Secure networks interconnection: a topology example . . . . .	195
133	Secure network interconnection: OpenVPN configuration . . . . .	197
134	Serial gateway – sample topology . . . . .	198
135	Serial gateway – expansion port configuration . . . . .	199

# List of Tables

1	Reset storage actions	6
2	Mobile connection status items	7
3	Ethernet status items	8
4	Peripheral port status description	8
5	System information items	9
6	Mobile network information details	11
7	Signal strength value ranges	12
8	Mobile network statistics details	12
9	Wi-Fi module information	14
10	Wi-Fi AP status details	14
11	Wi-Fi STA status details	16
12	Wi-Fi scan results description	18
13	Common interface types	20
14	Interface parameter descriptions	21
15	Backup routes status parameters	22
16	DHCP status column descriptions	23
17	WireGuard status parameter descriptions	25
18	Dynamic DNS status messages	26
19	Description of columns in the connections list	27
20	Network interface example – IPv4 and IPv6	31
21	Network interface global items	32
22	Dynamic DHCP server configuration	33
23	Static DHCP server configuration	33
24	IPv6 prefix delegation configuration	34
25	Supported roles for IEEE 802.1X authentication	36
26	802.1X authentication configuration	36
27	VLAN configuration options	43
28	VRRP instance configuration options	46
29	Connection checking parameters	46
30	Mobile WAN configuration items description	50
31	Check connection to mobile network configuration	52
32	Data limit configuration	53
33	SIM card switching configuration	54
34	Parameters for SIM card switching	55
35	Other settings	56
36	PPPoE configuration options	58
37	Wi-Fi configuration items description	60
38	WLAN configuration items description	65
39	Backup route mode descriptions	71
40	Backup routes interface configuration	71
41	Static routes configuration options	78
42	Incoming packet filtering	80
43	Forward packet filtering	81
44	Port forwarding rule configuration	84
45	Remote access configuration options	85
46	Default server and NAT helper configuration	86
47	OpenVPN configuration items	90
48	Authentication and security options	91
49	OpenVPN configuration example	92
50	Policy-based vs. route-based IPsec comparison	93
51	IPsec tunnel configuration items description	98

52	Simple IPv4 IPsec tunnel configuration . . . . .	101
53	WireGuard tunnel configuration options . . . . .	103
54	Cryptographic key configuration . . . . .	103
55	WireGuard IPv4 tunnel configuration example . . . . .	104
56	VXLAN configuration parameters . . . . .	106
57	Example of secure VXLAN bridge over VPN . . . . .	107
58	GRE tunnel configuration options . . . . .	108
59	GRE tunnel configuration example . . . . .	109
60	L2TP tunnel configuration options . . . . .	110
61	L2TP tunnel configuration example . . . . .	111
62	PPTP tunnel configuration options . . . . .	112
63	PPTP tunnel configuration example . . . . .	113
64	Dynamic DNS configuration settings . . . . .	114
65	Example of secure Dynamic DNS configuration . . . . .	115
66	FTP configuration items description . . . . .	116
67	Web server configuration items description . . . . .	117
68	LLDP configuration parameters . . . . .	119
69	NTP configuration items description . . . . .	121
70	SMTP client configuration settings . . . . .	122
71	SMS configuration . . . . .	123
72	Control via SMS . . . . .	123
73	Control SMS types . . . . .	124
74	Send SMS on the serial port 2 . . . . .	124
75	Sending and receiving SMS on a specified TCP port . . . . .	125
76	AT commands list . . . . .	125
77	SNMP configuration items description . . . . .	131
78	Object identifiers for digital inputs and outputs . . . . .	133
79	General SSH settings . . . . .	135
80	SSH host key settings . . . . .	136
81	Local logging settings . . . . .	138
82	Remote forwarding settings . . . . .	138
83	Remote server authentication settings . . . . .	139
84	Telnet configuration settings . . . . .	140
85	RS-232 serial port configuration items . . . . .	142
86	USR LED operation modes overview . . . . .	145
87	General authentication configuration options . . . . .	146
88	RADIUS configuration options . . . . .	148
89	TACACS+ configuration options . . . . .	149
90	Identification configuration items . . . . .	150
91	Automatic Update configuration options . . . . .	151
92	Available events . . . . .	156
93	Available actions . . . . .	156
94	Action definitions . . . . .	156
95	SNMP settings for events . . . . .	157
96	Quick Setup: Time and Region . . . . .	163
97	Quick Setup: LAN Port and DHCP Server . . . . .	163
98	Quick Setup: Mobile Network . . . . .	164
99	Quick Setup: System and Service Settings . . . . .	164
100	Router Apps server settings descriptions . . . . .	167
101	User action buttons . . . . .	169
102	New user parameters . . . . .	169
103	Profile management options . . . . .	175
104	Backup configuration items . . . . .	182
105	Restore from file options . . . . .	183
106	Update firmware page items . . . . .	185

107	Reboot schedule configuration items description . . . . .	188
-----	---	-----

# 1. Getting Started

## Important



To ensure a secure deployment, it is crucial to evaluate potential risks and configure the router to mitigate them. We strongly recommend consulting the [Security Guidelines](#) application note for fundamental security practices.

## 1.1 Document Contents

This manual provides detailed setup instructions for Advantech SmartStart routers, covering the following key areas:

- An overview of all available configuration environments, including the web interface, command line (SSH), and remote management platforms – detailed in Chapter [1.2 Configuration Environments](#).
- Item-by-item descriptions of all settings, structured to match the web interface menu:
  - **Status Pages** – Chapter [2 Status](#).
  - **Configuration Settings** – Chapter [3 Configuration](#).
  - **Customization Options** – Chapter [4 Customization](#).
  - **Administration Tools** – Chapter [5 Administration](#).
- Configuration examples for typical use cases – Chapter [6 Typical Use Cases](#).

## Info



For hardware-related topics, such as product ordering codes, physical features, initial hardware setup, and technical specifications, please refer to the **Hardware Manual** available on the [Engineering Portal](#).

## 1.2 Configuration Environments

### Warning

#### Important Notes Before Configuration

- Before putting the router into operation, ensure all required hardware components (antennas, SIM cards, etc.) are properly connected. For detailed instructions, refer to the [Hardware Manual](#) for your specific model.
- For security reasons, always keep the router's firmware updated to the latest version. Do not downgrade to a version older than the factory release or upload firmware intended for a different model, as this can cause malfunctions.
- It is highly recommended to have JavaScript enabled in your web browser. Without it, some functions and most field validation checks will be disabled.
- Three consecutive failed login attempts will temporarily block web access from that IP address for one minute.
- All routers have the *WebAccess/DMP* client pre-installed. When activated, the client periodically sends router identifiers and configuration data to the server. For more details, see Chapter [1.2.2 Remote Management Platform](#).
- If you are ever unsure about a configuration setting, please contact our technical support for assistance.

### Info

#### GUI Tips:

- Throughout the web interface, helpful information is displayed to the right of many input fields. For numeric items, this includes the valid range and unit. For other fields, you may find contextual hints or examples.
- When you hover the mouse over an input field, a tooltip will appear showing the item's internal configuration name. This is particularly useful for scripting or remote configuration (e.g., via *WebAccess/DMP*).

Advantech routers can be configured using one of the following environments:

- **Web Browser:** A graphical user interface (GUI) accessible via HTTP(S). This is the primary method covered in this manual, beginning with Chapter [1.2.1 Web Interface Initial Setup](#).
- **Command Line:** A console interface accessible via Secure Shell (SSH). For a detailed guide to all available commands, refer to the [Command Line Interface](#) Application Note.
- **Remote Management Platform:** Advantech's *WebAccess/DMP* platform allows for extensive remote management, monitoring, and mass configuration of routers. For more information, see Chapter [1.2.2 Remote Management Platform](#).

For information on extending the router's functionality with custom scripts and applications, see the [Extending Router Functionality](#) Application Note.

## 1.2.1 Web Interface Initial Setup

### Warning

Starting with firmware version 6.5.0, both IPv4 and IPv6 firewalls are enabled by default. Proper configuration of these settings is critical to avoid unintentionally blocking router communication during initial setup.

### Info

- Users with the *User* role have read-only access to the web interface, except for the ability to change their own password. Certain menu items are not available to non-admin users.
- On a new router, or after a factory reset, the *Quick Setup* page is displayed immediately after login, allowing for a streamlined initial configuration; see Chapter 3.24 *Quick Setup* for details.

Advantech routers feature a secure, HTTPS-based Web GUI that provides access to all configuration and monitoring functions. The interface offers real-time network statistics, signal strength information, system log access, and comprehensive device management. To ensure secure communication, the Web GUI enforces TLS 1.2 or higher and requires certificate validation to prevent man-in-the-middle attacks.

Figure 1 shows the main elements of the interface, including the router identification header, the navigation menu, and the workspace where detailed configuration options are displayed. These clearly defined sections help users quickly locate system information, adjust operating parameters, and manage administrative settings.

To access the web interface for the first time on a factory-default router:

1. **Hardware Preparation:** For cellular models, insert an active SIM card. For detailed instructions, see the *Hardware Manual* for your specific model. Attach all required antennas before powering on the device and use only an Advantech-approved power supply as specified in the hardware documentation.
2. **Network Connection:** During boot-up, the router's DHCP server activates on the ETH0 interface. Connect your computer to this port and ensure it is configured to obtain an IP address automatically via DHCP. The router will assign your computer an IP address from the `192.168.1.0/24` range.
3. **Web Access:** Open a modern web browser and navigate to `https://192.168.1.1`. Note that unsecured HTTP connections are not permitted.
4. **Login Credentials:** The factory-default administrator account is `root`. The password for this account is printed on the router's product label<sup>1</sup>.
5. **Initial Setup:** Upon your first login, you will be required to change the default password. The new password must meet the complexity requirements detailed in Chapter 3.20.1 *Authentication*. You will then be automatically directed to the *Quick Setup* page to complete the initial configuration, as described in Chapter 3.24 *Quick Setup*.
6. **Certificate Trust:** To avoid browser certificate warnings, it is recommended to install the router's self-signed certificate or upload a certificate from a trusted Certificate Authority (CA), as described in subsection *Managing HTTPS Certificates*.

<sup>1</sup>On older models where the label does not specify a password, the default is `root`.

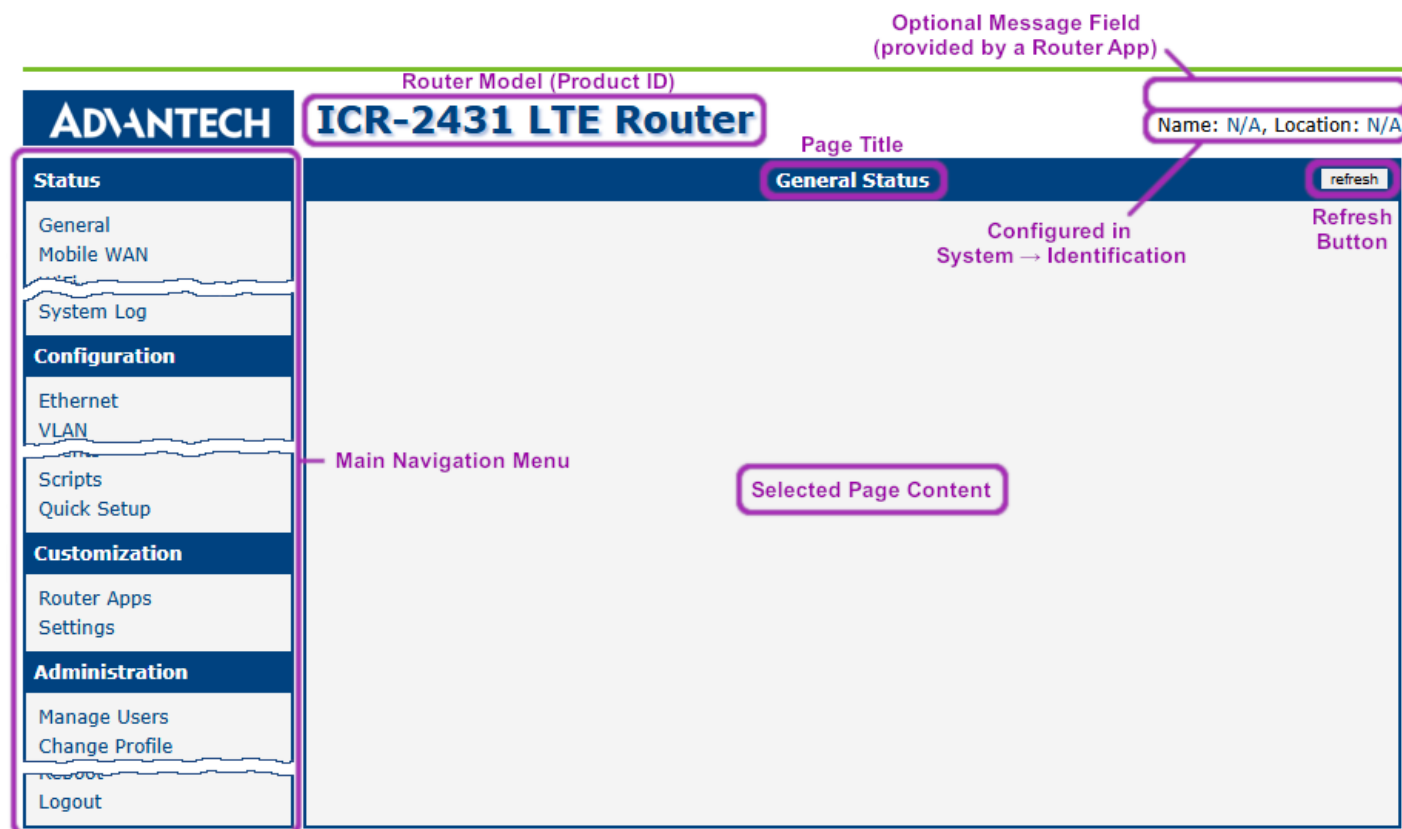

Figure 1: Web GUI layout overview

## Managing HTTPS Certificates

By default, the router uses a self-signed HTTPS certificate. Because this certificate is not issued by a trusted Certificate Authority (CA), your web browser will display a security warning each time you access the web interface.

To avoid this warning, we recommend uploading a certificate signed by a trusted CA. This can be done on the *HTTP* configuration page, as described in Chapter 3.18.3 *HTTP*.

You will need to replace the `/etc/certs/https_cert` and `/etc/certs/https_key` files on the router.

As an alternative, you can add the router’s self-signed certificate to your browser’s or operating system’s trust store. This will suppress the security warnings without needing a CA-signed certificate.

## Allowed and Restricted Input Characters

When entering information into any configuration field in the web interface, it is important to use only permitted characters. Using forbidden characters can lead to unpredictable behavior or errors.

- **Allowed characters:** 0-9 a-z A-Z \* , + - . / : = ? ! # % @ [ ] \_ { } ~
- **Forbidden characters:** " \$ & ' ( ) ; < > ^ ` |

### Warning

Although the system may allow you to save non-ASCII characters after confirming a warning message, using them, especially for passwords, is **not recommended** as it can cause compatibility issues with other systems.

## Supported Certificate Formats

The web interface supports the following file formats for certificate and private key uploads:

- **Certificates (CA, Local, Remote):** `.pem`, `.crt`, `.p12`
- **Private Keys:** `.pem`, `.key`, `.p12`

Ensure that your files are in one of these formats to guarantee a successful upload.

## 1.2.2 Remote Management Platform

*WebAccess/DMP* is an advanced, cloud-based platform designed for the bulk management of Advantech routers and IoT gateways. It provides a centralized system for monitoring, configuring, and provisioning devices at scale. Key features include:

- Zero-touch provisioning for new device deployments.
- Mass configuration and firmware updates.
- Real-time status monitoring and alerts.
- Secure remote access to device web interfaces and command lines.

For more information, visit the official [WebAccess/DMP](#) website.

## Client Configuration

The *WebAccess/DMP* client (Router App) is pre-installed and enabled by default in the standard (non-customized) router configuration. The connection to the server can be managed from several locations in the web interface:

- *Configuration* → *Quick Setup* (during initial setup or later)
- *Customization* → *Router Apps* → *WebAccess/DMP Client*

### Warning

When the *WebAccess/DMP* client is enabled, the router will periodically upload its configuration and identifying information (such as MAC address and IMEI) to the management server.

## 1.3 Device

### 1.3.1 Persistent Storage

The device's persistent storage is divided into three main partitions:

- **System Data:** Contains the core operating system and firmware files.
- **User Data:** A separate partition for user-created files and data, accessible at `/var/data`.
- **Router Apps:** A dedicated partition for installed Router Apps, accessible at `/opt`.

### 1.3.2 Reset Procedures

#### Warning

Before performing any reset that restores factory defaults, it is highly recommended to back up your current configuration. See Chapter [5.7 Backup Configuration](#) for instructions.

The router offers three distinct reset procedures to handle different scenarios. The method for initiating these resets varies based on the router model.

- **Reboot (Software Reset):** This action simply restarts the router, keeping the currently saved configuration. It can be triggered from the *Reboot* page in the web interface. On models with an *RST* button, a brief press of **less than 4 seconds** also initiates a reboot.
- **Configuration Reset (Factory Reset):**<sup>1</sup> This procedure restores the router to its original factory settings, including all router and Router App configurations.
  - On these models, this reset is triggered by a single press of the *RST* button.
- **Emergency Reset:**<sup>1</sup> This is a recovery procedure for situations where the router fails to boot, often due to a configuration error or filesystem issue. It resets all configurations to factory defaults.
  - Disconnect the router from its power source.
  - Press and hold the *RST* button.
  - While still holding the button, reconnect the power and continue holding for **at least 10 seconds**.

The following table summarizes how each reset procedure affects the data stored on the router.

Storage	Reset	Configuration Reset	Emergency Reset
Router & RA Configuration	Keep	Reset to default	Reset to default
System Data	Keep	Keep	Keep
User Data	Keep	Keep	Keep
Installed Router Apps	Keep	Keep	Keep
User Account Locks	Keep	Keep	Remove
Factory Reset of Cellular Module	No	No	Yes

Table 1: Reset storage actions

<sup>1</sup>Upon first login after a reset, the user will be prompted to change their password.

## 2. Status

### Info

All status pages can display live data. To enable this feature, click the *refresh* button in the top-right corner of the page. To stop the automatic updates and reduce data transfer, click the *pause* button.

### 2.1 General

The *Status* → *General* page provides a summary of the router's basic information and current activities. The content is divided into sections based on the router's hardware configuration and may include status information for the mobile connection, LAN interfaces, system details, Wi-Fi, and peripheral ports.

### Info

An IPv6 interface can have multiple addresses simultaneously. If you click *More Information*, you may see an additional IPv6 address in the EUI-64 format. This is a link-local address, automatically generated from the interface's MAC address, and is standard behavior for IPv6.

### Mobile Connection

This section displays real-time status and traffic statistics for the active mobile WAN connection.

Item	Description
<i>SIM Card</i>	The currently active SIM card (1st or 2nd).
<i>Interface</i>	The name of the network interface (e.g., <i>usb0</i> ).
<i>Flags</i>	The current status flags for the interface: <ul style="list-style-type: none"><li>• <b>Up</b>: The interface is administratively enabled.</li><li>• <b>Running</b>: The interface is operational and connected.</li><li>• <b>Multicast</b>: The interface supports multicast traffic.</li></ul>
<i>IP Address</i>	The IP address assigned to the interface by the mobile operator.
<i>MTU</i>	Maximum Transmission Unit: the largest packet size (in bytes) that can be transmitted over the interface.
<i>Rx Data / Tx Data</i>	The total amount of data received (Rx) and transmitted (Tx).
<i>Rx Packets / Tx Packets</i>	The total number of packets received (Rx) and transmitted (Tx).
<i>Rx Errors / Tx Errors</i>	The number of packets with errors (e.g., failed checksums) during reception (Rx) or transmission (Tx).
<i>Rx Dropped / Tx Dropped</i>	The number of packets that were dropped, likely due to a lack of system resources (e.g., full buffers).
<i>Rx Overruns / Tx Overruns</i>	The number of packets lost because the hardware buffer was full before the system could process the previous packet.
<i>Uptime</i>	The duration of the current, active mobile network connection.

Table 2: Mobile connection status items

## Ethernet

Each physical Ethernet port (e.g., eth0, eth1) has a dedicated section on the *General* status page.

Item	Description
<i>Interface</i>	The name of the network interface (e.g., eth0).
<i>Flags</i>	The current status flags for the interface (see Table 2 for details).
<i>IP Address</i>	The IPv4 address configured for this interface.
<i>IPv6 Address</i>	The IPv6 address configured for this interface.
<i>MAC Address</i>	The unique Media Access Control (MAC) address of the hardware interface.
<i>MTU</i>	The Maximum Transmission Unit for the interface.
<i>Rx Data / Tx Data</i>	The total amount of data received (Rx) and transmitted (Tx).
<i>Rx Packets / Tx Packets</i>	The total number of packets received (Rx) and transmitted (Tx).
<i>Rx Errors / Tx Errors</i>	The number of packets with errors during reception (Rx) or transmission (Tx).
<i>Rx Dropped / Tx Dropped</i>	The number of packets dropped due to resource limitations.
<i>Rx Overruns / Tx Overruns</i>	The number of packets lost due to hardware buffer overruns.

Table 3: Ethernet status items

## Wi-Fi

The *WiFi AP 1* and *WiFi AP 2* sections display information about the Wi-Fi interfaces operating as Access Point 1 and Access Point 2. The items displayed here have the same meaning as the items described in Table 3. The *DFS* item indicates whether Dynamic Frequency Selection (DFS) is supported. DFS is a mechanism that allows access points in the 5 GHz spectrum to operate on restricted channels, requiring them to switch to a different channel if interference with priority services (such as radar) is detected. For configuration details, see Chapter 3.6.1 *Access Point*.

The *WiFi STA* section displays information about the Wi-Fi interface operating in Station (STA) mode. For configuration details, see Chapter 3.6.2 *Station*. The items displayed here have the same meaning as the items described in Table 3.

## Peripheral Ports

This section displays the status of all installed peripheral ports on the router.

Item	Description
Expansion Port	Router's serial interface (DB9 connector on the front panel).
Digital Input	The current state of digital input.
Digital Output	The current state of digital output.

Table 4: Peripheral port status description

## Security Information

This section provides information about the currently logged-in user, including their last login time, the IP address from which they connected, and the number of failed login attempts since the last successful login.

## System Information

The *System Information* section displays key details about the router's hardware, software, and current operational state. Note that some items are only displayed after clicking the *More Information* link.

Item	Description
<i>Part Number</i>	The specific ordering code that identifies the product's exact hardware and software configuration. This is typically printed on the label on the device itself.
<i>Product Type</i>	The hardware model name of the router which identifies the exact hardware configuration. It corresponds to the <i>Model no.</i> stated in the datasheet.
<i>Product Name</i>	The commercial name of the product family that shares the same firmware base.
<i>Firmware Version</i>	The version of the firmware currently installed on the router.
<i>Serial Number</i>	The unique serial number of the device.
<i>Hardware UUID<sup>1</sup></i>	A permanent, non-changeable Unique Hardware Identifier for the device.
<i>Product Revision<sup>1</sup></i>	The manufacturing revision number of the router's hardware.
<i>Profile</i>	The currently active configuration profile (e.g., Standard or an alternative profile).
<i>Free Space</i>	The amount of available storage for Router Apps and user data.
<i>CPU Usage</i>	The current processor load, shown as a percentage. Enable auto-refresh to see live data.
<i>Memory Usage</i>	The current RAM usage, shown as a percentage. Enable auto-refresh to see live data.
<i>RTC Battery</i>	The status of the internal Real-Time Clock battery (e.g., OK, Low).
<i>Supply Voltage</i>	The current input voltage being supplied to the router.
<i>Temperature</i>	The internal temperature of the router.
<i>Time</i>	The current system date and time.
<i>Uptime</i>	The total time elapsed since the router was last rebooted.
<i>Licenses</i>	A link to a list of open-source software components used in the firmware, along with their respective licenses.

Table 5: System information items

<sup>1</sup>This item may not be available on all router models.

<sup>2</sup>Visible only on models equipped with a PoE expansion board.

## 2.2 Mobile WAN

The *Status* → *Mobile WAN* page provides a comprehensive, real-time overview of the router’s cellular connection. It is divided into three main sections: Mobile Network Information, Connection Statistics, and a detailed Connection Log.

**Mobile WAN Status**
refresh

**Mobile Network Information**

Registration	: Home Network
Operator	: Vodafone CZ
Technology	: LTE
PLMN	: 23003
Cell	: 10A804
TAC	: 947C
Channel	: 1849
Band	: B3
Signal Strength	: -85 dBm
Signal Quality	: -11 dB
RSSI	: -55 dBm
RSRP	: -85 dBm
RSRQ	: -11 dB
SINR	: 18 dB
CSQ	: 14
Manufacturer	: Quectel
Model	: EM12-G
Revision	: EM12GPAR01A20M4G
Firmware Release	: EM12GPAR01A20M4G_01.300.01.300
IMEI	: 869 518
ICCID	: 894 9019
IMSI	: 230 901
SMS Center	: +420 681

» [Less Information](#) «

**Statistics for 1st SIM card**

Interval	: Today	Yesterday	This Week	Last Week	This Period	Last Period
Rx Data	: 422 KiB	11 KiB	434 KiB	0 KiB	434 KiB	0 KiB
Tx Data	: 184 KiB	7 KiB	191 KiB	0 KiB	191 KiB	0 KiB
Connections	: 18	15	34	0	34	0
Signal Min	: -91 dBm	N/A	-91 dBm	N/A	-91 dBm	N/A
Signal Avg	: -87 dBm	N/A	-87 dBm	N/A	-87 dBm	N/A
Signal Max	: -83 dBm	N/A	-83 dBm	N/A	-83 dBm	N/A
Cells	: 69	13	83	0	83	0
Availability	: 96.9%	55.8%	94.6%	0.0%	94.6%	0.0%

**Statistics for 2nd SIM card**

Interval	: Today	Yesterday	This Week	Last Week	This Period	Last Period
Rx Data	: 494 KiB	2 KiB	496 KiB	0 KiB	496 KiB	0 KiB
Tx Data	: 146 KiB	2 KiB	148 KiB	0 KiB	148 KiB	0 KiB
Connections	: 2	1	3	0	3	0
Signal Min	: -91 dBm	N/A	-91 dBm	N/A	-91 dBm	N/A
Signal Avg	: -87 dBm	N/A	-87 dBm	N/A	-87 dBm	N/A
Signal Max	: -83 dBm	N/A	-83 dBm	N/A	-83 dBm	N/A
Cells	: 1	1	1	0	1	0
Availability	: 26.9%	21.5%	26.0%	0.0%	26.0%	0.0%

**Connection Log**

2025-11-12 06:06:29 (1st SIM card) Connection successfully established.

Figure 2: Mobile WAN status page

## Mobile Network Information

This section displays detailed information about the current network connection and the cellular module.

Item	Description
<b>Network Parameters</b>	
<i>Registration</i>	The current registration status on the mobile network (e.g., Registered, Home Network; Registered, Roaming).
<i>Operator</i>	The name of the currently connected mobile network operator.
<i>Technology</i>	The cellular technology in use (e.g., 5G, LTE, UMTS, GPRS).
<i>PLMN</i>	The Public Land Mobile Network code, a unique identifier for the mobile operator.
<i>Cell</i>	The hexadecimal ID of the cell tower to which the router is currently connected.
<i>LAC/TAC</i>	The Location Area Code (for 2G/3G) or Tracking Area Code (for 4G/5G), which identifies the current location area of the device within the network.
<i>Channel</i>	The specific radio frequency channel number being used (e.g., ARFCN, UARFCN, EARFCN).
<i>Band</i>	The frequency band being used for the connection (e.g., LTE Band 20).
<b>Signal Quality</b>	
<i>Signal Strength</i>	The primary signal strength metric (RSCP for UMTS, RSRP for LTE/5G, RSSI for GPRS). The value is color-coded for quick assessment: good (black), fair (orange), or poor (red). See Table 7 for detailed ranges.
<i>Signal Quality</i>	The primary signal quality metric (EC/IO for UMTS, RSRQ for LTE/5G). Not available for GPRS/EDGE.
<i>RSSI, RSRP, RSRQ, SINR</i>	Additional signal metrics providing deeper insight into connection quality. Availability depends on the module and technology.
<i>CSQ</i>	A simplified signal quality indicator from 0 to 31, where a higher value indicates better signal.
<i>Neighbours</i>	A list of neighboring cell signals, which can be useful for diagnostics (available only in GPRS mode on certain models).
<b>Module Information</b>	
<i>Manufacturer, Model, Revision</i>	Identifying details for the installed cellular module.
<i>Firmware Release</i>	Displays the full version string of the firmware currently running on the cellular module. This identifier is used for managing Firmware Over-The-Air (FOTA) updates for the module itself.
<i>IMEI / MEID</i>	The unique identifier for the cellular module hardware.
<i>ICCID</i>	The unique serial number of the inserted SIM card.
<i>IMSI</i>	The International Mobile Subscriber Identity, a unique number that identifies the SIM card on the mobile network.
<i>SMS Center</i>	The phone number of the Short Message Service Center (SMSC) provided by the mobile operator.

Table 6: Mobile network information details

The following table provides a general guide for interpreting signal strength values.

Signal Level	2G/3G (RSSI/RSCP)	4G (RSRP)	5G (RSRP)
Good	> -75 dBm	> -90 dBm	> -90 dBm
Fair	-75 dBm to -94 dBm	-90 dBm to -109 dBm	-90 dBm to -119 dBm
Poor	< -94 dBm	< -109 dBm	< -119 dBm

Table 7: Signal strength value ranges

## Connection Statistics

This section provides usage and performance data for each SIM card over various time periods. The accounting periods can be customized on the *Configuration* → *Mobile WAN* page.

Item	Description
<i>RX / TX data</i>	The total volume of data received (RX) and transmitted (TX).
<i>Connections</i>	The total number of successful network connections.
<i>Signal Min / Avg / Max</i>	The minimum, average, and maximum signal strength recorded. Hovering over the Min/Max values will display a timestamp of their last occurrence.
<i>Cells</i>	The number of times the router has switched between cell towers.
<i>Availability</i>	The percentage of time the router has been successfully connected to the network since the SIM was activated.

Table 8: Mobile network statistics details

## Connection Log

This section displays a detailed, real-time log of events related to the mobile network connection. It is an invaluable tool for troubleshooting, as it records the step-by-step process of network registration and clearly indicates any errors encountered.

## 2.3 Wi-Fi

### 2.3.1 Status

The *Status* → *Wi-Fi* page displays the current operational status of the Wi-Fi module and all configured interfaces, including Access Point (AP) and Station (STA) modes.

The screenshot shows the 'WiFi Status' page with a 'refresh' button in the top right corner. The page is divided into three main sections:

- WiFi Module Information:**
  - Chip : Texas Instruments WL1837
  - Firmware : Rev 8.9.0.0.88
  - Supports : 1 station and 1 access point, or 2 access points
- WiFi AP 1 Status:**
  - bssid=78:a5:04:26:93:a2
  - ssid=PrivateNet
  - wpa=2
  - key\_mgmt=SAE
  - group\_cipher=CCMP
  - rsn\_pairwise\_cipher=CCMP

**Common AP Information**

  - 94:e3:6d:98:48:9d
  - flags=[AUTH][ASSOC][AUTHORIZED][SHORT\_PREAMBLE]
  - capability=0x431
  - listen\_interval=20
  - supported\_rates=02 04 0b 16
  - wpa=2
  - AKMSuiteSelector=00-0f-ac-8
  - rx\_packets=22
  - tx\_packets=7
  - rx\_bytes=2498
  - tx\_bytes=1325
  - inactive\_msec=1070
  - signal=0
  - rx\_rate\_info=110
  - tx\_rate\_info=10
  - connected\_time=18
  - sae\_group=19
  - sae\_rejected\_groups=
  - supp\_op\_classes=5151525354737475767778797a7b7c7d7e7f
  - ext\_capab=0400000000000040

**Information of One Connected Station**
- WiFi AP 2 Status:**
  - AP status is not available.
- WiFi STA Status:**
  - STA status is not available.

Figure 3: Wi-Fi AP status page

## Wi-Fi Module Information

This section provides hardware-specific details about the installed Wi-Fi module.

Item	Description
<i>Chip</i>	The model of the Wi-Fi chipset.
<i>Firmware</i>	The version of the firmware running on the Wi-Fi module.
<i>Supports</i>	Lists the number of simultaneous interfaces the module can handle. For example, <i>1 station and 2 access points</i> indicates that the router can act as a client to one network while concurrently operating two separate access point interfaces.

Table 9: Wi-Fi module information

## Wi-Fi AP Status

The *WiFi AP 1 Status* and *WiFi AP 2 Status* sections display information about the Wi-Fi interfaces operating in Access Point mode. As shown in Figure 3, this includes common AP settings followed by a list of connected stations (clients). Each block of connected station data begins with the client's MAC address, followed by the items described in the table below.

Column/Item	Description
<b>Common AP Information</b>	
<i>bssid</i>	The MAC address of the Wi-Fi access point interface.
<i>ssid</i>	The Service Set Identifier (network name) broadcast by the access point.
<i>wpa</i>	Indicates the WPA standard version bitmask currently in use (e.g., 2 indicates support for WPA2/RSN standards). Note that WPA3 also utilizes the RSN framework; to distinguish between WPA2 and WPA3, refer to the <i>key_mgmt</i> field.
<i>key_mgmt</i>	The Key Management Method used for authentication. Common values include <i>WPA2-PSK</i> (WPA2 Personal) and <i>SAE</i> (WPA3 Personal).
<i>group_cipher</i>	The encryption protocol used for broadcast and multicast traffic within the network (e.g., <i>CCMP</i> , <i>TKIP</i> ).
<i>rsn_pairwise_cipher</i>	Encryption protocol used for unicast traffic (e.g., <i>CCMP</i> ).
<b>Connected Station Information</b>	
<i>[MAC Address]</i>	The MAC address of the connected client device.
<i>flags</i>	Connection flags indicating current state (e.g., <i>[AUTH]</i> , <i>[ASSOC]</i> , <i>[AUTHORIZED]</i> ).
<i>capability</i>	A hexadecimal bitmask indicating the station's advertised capabilities (e.g., support for ESS, IBSS, Privacy, Short Preamble) as defined in the IEEE 802.11 standard.
<i>listen_interval</i>	The number of beacon intervals for which the station may enter power-saving mode (sleep) before waking up to receive beacon frames.
<i>supported_rates</i>	A list of data transmission rates (in Mbps or hexadecimal representation) that the station supports.
<i>wpa</i>	Indicates the WPA standard version currently in use for this connection (e.g., 2 indicates support for WPA2/RSN standards). Note that WPA3 also utilizes the RSN framework.
<i>AKMSuiteSelector</i>	The Authentication and Key Management suite selector used. It identifies the authentication method (e.g., <i>00-0f-ac-8</i> for SAE/WPA3 or <i>00-0f-ac-2</i> for WPA2-PSK).

Table 10: Wi-Fi AP status details

<b>Item</b>	<b>Description</b>
<i>rx_packets</i>	Number of packets received from this station.
<i>tx_packets</i>	Number of packets transmitted to this station.
<i>rx_bytes</i>	Number of bytes received from this station.
<i>tx_bytes</i>	Number of bytes transmitted to this station.
<i>inactive_msec</i>	The time in milliseconds since the last data packet was received from the station. A lower value indicates an active connection.
<i>signal</i>	Signal strength of the connected station (in dBm).
<i>rx_rate_info</i>	Information about the last received data rate from the station (e.g., bitrate index or MCS index).
<i>tx_rate_info</i>	Information about the last transmitted data rate to the station (e.g., bitrate index or MCS index).
<i>connected_time</i>	Duration of the current connection in seconds.
<i>sae_group</i>	The Diffie-Hellman group (ECC curve) used during the WPA3 SAE handshake (e.g., 19 for NIST P-256). Only applicable when WPA3 (SAE) is used.
<i>sae_rejected_groups</i>	A list of SAE groups that were proposed but rejected during the handshake process.
<i>supp_op_classes</i>	Supported Operating Classes. A hexadecimal string listing the frequency bands and channel behaviors the station supports.
<i>ext_capab</i>	Extended Capabilities. A hexadecimal bitfield indicating support for advanced features (e.g., BSS Transition, WNM) beyond the standard capability field.

Table 10: Wi-Fi AP status details (continued)

## Wi-Fi STA Status

The *WiFi STA Status* section displays information about the Wi-Fi interface operating in Station (Client) mode.

The screenshot shows the 'WiFi Status' page with a 'refresh' button in the top right. The page is divided into three main sections:

- WiFi Module Information:**
  - Chip : Texas Instruments WL1837
  - Firmware : Rev 8.9.0.0.88
  - Supports : 1 station and 1 access point, or 2 access points
- WiFi AP 1 Status:**
  - AP status is not available.
- WiFi AP 2 Status:**
  - AP status is not available.
- WiFi STA Status:**
  - bssid=78:a5:04:26:93:a2
  - freq=2472
  - ssid=PrivateNet
  - id=0
  - mode=station
  - pairwise\_cipher=CCMP
  - group\_cipher=CCMP
  - key\_mgmt=SAE
  - sae\_group=19
  - sae\_h2e=1
  - sae\_pk=0
  - wpa\_state=COMPLETED
  - ip\_address=192.168.100.10
  - address=94:e3:6d:98:48:9d
  - ssid\_verified=1

Figure 4: Wi-Fi STA status page

Item	Description
<i>bssid</i>	The MAC address of the Access Point to which the station is connected.
<i>freq</i>	The operating frequency (channel) in MHz (e.g., 2472 corresponds to channel 13).
<i>ssid</i>	The name of the Wi-Fi network the station is connected to.
<i>id</i>	The internal numeric identifier of the configured network profile in the wpa_supplicant.
<i>mode</i>	Operation mode ( <i>station</i> ).
<i>pairwise_cipher</i>	The encryption protocol used for unicast data traffic between the station and the access point (e.g., <i>CCMP</i> , <i>GCMP</i> , <i>TKIP</i> ).
<i>group_cipher</i>	The encryption protocol used for broadcast and multicast traffic within the network (e.g., <i>CCMP</i> , <i>TKIP</i> ).

Table 11: Wi-Fi STA status details

<b>Item</b>	<b>Description</b>
<i>key_mgmt</i>	The Key Management protocol used for authentication. Common values include <i>WPA-PSK</i> (WPA2 Personal) and <i>SAE</i> (WPA3 Personal).
<i>sae_group</i>	The Diffie-Hellman group (ECC curve) used during the WPA3 SAE handshake (e.g., <i>19</i> for NIST P-256). Only applicable when WPA3 (SAE) is used.
<i>sae_h2e</i>	Indicates if the "Hash-to-Element" method was used for SAE password derivation. <i>1</i> means H2E was used (mandatory for WPA3 in 6 GHz), <i>0</i> means the older "Hunting-and-Pecking" loop method was used.
<i>sae_pk</i>	Indicates if SAE Public Key (SAE-PK) authentication was used. <i>1</i> means SAE-PK was used to cryptographically bind the SSID to the password (preventing rogue APs), <i>0</i> means standard SAE was used.
<i>wpa_state</i>	The current state of the connection. <i>COMPLETED</i> indicates a successful connection. States like <i>SCANNING</i> or <i>DISCONNECTED</i> imply the router is searching for a network or cannot connect (check credentials or signal).
<i>ip_address</i>	The IP address assigned to the station interface, either obtained dynamically from a DHCP server or configured statically.
<i>address</i>	The MAC address of the router's Wi-Fi station interface.
<i>ssid_verified</i>	Indicates if the SSID has been verified (e.g., <i>1</i> for true). Only applicable when WPA3 (SAE) is used.

Table 11: Wi-Fi STA status details (continued)

### 2.3.2 Scan

The *Status* → *Wi-Fi* → *Scan* page allows you to discover all nearby Wi-Fi networks. The results are displayed in a list, showing the key parameters of each detected network.



Figure 5: Wi-Fi scan results

The list is structured into several columns, and each entry provides a *Connect* button and a link to view *More Information*.

Column/Item	Description
<i>BSS</i>	The MAC address of the detected access point.
<i>Signal Icon</i>	A visual representation of the signal strength. More bars indicate a stronger signal.
<i>Connect button</i>	Clicking this button redirects you to the <i>Configuration</i> → <i>Wi-Fi</i> → <i>Station</i> page with the selected network’s details pre-filled, allowing you to easily connect by entering the password.
<i>Channel/Band</i>	The channel number and frequency band the network is operating on.
<i>Security</i>	The security protocol and encryption method used by the network (e.g., WPA2-PSK/AES).
<i>SSID</i>	The public name of the Wi-Fi network.
<i>More Information</i>	Clicking this link expands a section with detailed technical parameters of the access point, intended for advanced diagnostics.

Table 12: Wi-Fi scan results description

## 2.4 Network

To view detailed information about network interfaces, routing tables, and active connections, navigate to the *Status* → *Network* page. The upper part of the page displays details for all active network interfaces, followed by the IPv4 and IPv6 routing tables.

**Network Status**
refresh

**Interfaces**

```

eth0      Link encap:Ethernet  HWaddr 02:AD:FF:00:01:20
          inet addr:10.64.0.120  Bcast:10.64.3.255  Mask:255.255.252.0
          inet6 addr: fe80::ad:ffff:fe00:120/64 Scope:Link
          inet6 addr: fd00:a40::120/56 Scope:Global
          UP BROADCAST RUNNING MULTICAST  MTU:1500  Metric:1
          RX packets:77904 errors:0 dropped:0 overruns:0 frame:0
          TX packets:76396 errors:0 dropped:0 overruns:0 carrier:0
          collisions:0 txqueuelen:1000
          RX bytes:6015974 (5.7 MB)  TX bytes:38486283 (36.7 MB)
          Interrupt:25 Base address:0xc000

eth1      Link encap:Ethernet  HWaddr 02:AD:FF:01:01:20
          Link encap:Ethernet  HWaddr 02:AD:FF:01:01:20
          inet addr:10.64.0.121  Bcast:10.64.3.255  Mask:255.255.252.0
          inet6 addr: fe80::ad:ffff:fe00:121/64 Scope:Link
          inet6 addr: fd00:a40::121/56 Scope:Global
          UP BROADCAST RUNNING MULTICAST  MTU:1500  Metric:1
          RX packets:77904 errors:0 dropped:0 overruns:0 frame:0
          TX packets:76396 errors:0 dropped:0 overruns:0 carrier:0
          collisions:0 txqueuelen:1000
          RX bytes:6015974 (5.7 MB)  TX bytes:38486283 (36.7 MB)
          Interrupt:25 Base address:0xc000

lo        Link encap:Local Loopback
          inet addr:127.0.0.1  Mask:255.0.0.0
          inet6 addr: ::1/128 Scope:Host
          UP LOOPBACK RUNNING  MTU:65536  Metric:1
          RX packets:31127 errors:0 dropped:0 overruns:0 frame:0
          TX packets:31127 errors:0 dropped:0 overruns:0 carrier:0
          collisions:0 txqueuelen:1000
          RX bytes:5001471 (4.7 MB)  TX bytes:5001471 (4.7 MB)

null10   Link encap:Ethernet  HWaddr 3E:9C:AF:63:42:B3
          inet6 addr: fe80::3c9c:afff:fe63:42b3/64 Scope:Link
          UP BROADCAST RUNNING NOARP  MTU:1500  Metric:1
          RX packets:0 errors:0 dropped:0 overruns:0 frame:0
          TX packets:1 errors:0 dropped:0 overruns:0 carrier:0
          collisions:0 txqueuelen:1000
          RX bytes:0 (0.0 B)  TX bytes:70 (70.0 B)

usb0     Link encap:Ethernet  HWaddr CA:BF:16:A8:56:88
          inet addr:10.80.0.100  Bcast:0.0.0.0  Mask:255.255.255.255
          UP BROADCAST RUNNING NOARP MULTICAST  MTU:1500  Metric:1
          RX packets:2 errors:0 dropped:0 overruns:0 frame:0
          TX packets:20 errors:0 dropped:0 overruns:0 carrier:0
          collisions:0 txqueuelen:1000
          RX bytes:588 (588.0 B)  TX bytes:2138 (2.0 KB)
          
```

**Route Table**

Destination	Gateway	Genmask	Flags	Metric	Ref	Use	Iface
0.0.0.0	192.168.253.254	0.0.0.0	UG	0	0	0	usb0
10.64.0.0	0.0.0.0	255.255.252.0	U	0	0	0	eth0
10.65.0.0	0.0.0.0	255.255.252.0	U	0	0	0	eth1
192.168.253.254	0.0.0.0	255.255.255.255	UH	0	0	0	usb0

**IPv6 Route Table**

Destination	Next Hop	Flags	Metric	Ref	Use	Iface
fd00:a40::/56	::	U	256	3	0	eth0
10.64.0.0	::	U	256	2	0	eth0
ff00::/8	::	U	256	2	0	eth1
::/0	::	!n	-1	1	0	lo

**Backup Routes**

```

WAN IP Interface   : eth0
WAN IP Address     : 10.40.28.252
WAN IPv6 Interface : N/A
WAN IPv6 Address   : N/A
          
```

**LLDP Neighbors**

```

LLDP service is disabled.
          
```

Figure 6: Network status page overview

## Interfaces

This section provides an overview of all active network interfaces on the router. For each interface, it displays essential information such as assigned IP addresses, MAC address, and traffic statistics (received and transmitted data). In the table below, the X in an interface name represents its zero-indexed instance number. The availability of specific interfaces depends on the router model and its configuration.

Interface	Description
<i>ethX</i>	A physical Ethernet interface directly connected to the CPU. The index <i>X</i> identifies the interface instance (e.g., <i>eth0</i> , <i>eth1</i> ).
<i>vlanX</i>	A logical VLAN interface. The index <i>X</i> is an internal interface number and does not match the configured VLAN ID. The actual VLAN ID is defined separately and mapped to this logical interface.
<i>lo</i>	The virtual loopback interface used for internal communication within the router.
<i>null0</i>	A virtual interface used by the NAT64 translator. Traffic routed to this interface is discarded.
<i>usb0, usb1</i>	Interfaces representing the cellular WAN connections for the first or second modem module. These interfaces are connected internally via the USB bus.
<i>wlanX</i>	A Wi-Fi interface, where <i>X</i> identifies the physical radio or a virtual access point instance.
<i>pppoeX</i>	A virtual interface for a PPPoE session, where <i>X</i> is the instance number.
<i>tunX</i>	A virtual interface for an OpenVPN tunnel, where <i>X</i> is the tunnel instance number (0–3).
<i>ipsecX</i>	A virtual interface for an IPsec tunnel, where <i>X</i> is the tunnel instance number (0–3).
<i>wgX</i>	A virtual interface for a WireGuard tunnel, where <i>X</i> is the tunnel instance number (0–3).
<i>greX</i>	A virtual interface for a GRE tunnel, where <i>X</i> is the tunnel instance number (0–3).
<i>l2tp0</i>	A virtual interface for an L2TP tunnel. Only one instance is supported.
<i>pptp0</i>	A virtual interface for a PPTP tunnel. Only one instance is supported.

Table 13: Common interface types

Each active interface provides a detailed summary of its status and traffic statistics. The parameters are described below.

Parameter	Description
<i>HWaddr</i>	The hardware Media Access Control (MAC) address of the interface.
<i>inet addr</i>	The primary IPv4 address assigned to the interface.
<i>inet6 addr</i>	The primary IPv6 address assigned to the interface. An interface may have multiple IPv6 addresses.
<i>P-t-P</i>	For a point-to-point link, this is the IP address of the remote peer.
<i>Bcast</i>	The broadcast address for the interface's subnet.
<i>Mask</i>	The subnet mask associated with the IPv4 address.
<i>MTU</i>	The Maximum Transmission Unit, indicating the largest packet size (in bytes) that the interface can transmit without fragmentation.
<i>Metric</i>	A value used by the routing table to determine the cost of a route. Lower values are preferred.
<i>RX/TX packets</i>	The total count of packets received (RX) and transmitted (TX) by the interface.
<i>Errors</i>	A count of errors that occurred during reception or transmission.
<i>Dropped</i>	The number of packets that were dropped during reception or transmission, often due to a lack of buffer space.
<i>Overruns</i>	The number of packets lost due to buffer overloads.
<i>Frame</i>	The number of received packets dropped due to framing errors (e.g., incorrect checksums).
<i>Carrier</i>	The number of transmission errors related to the physical layer carrier signal.
<i>Collisions</i>	The number of packet collisions detected on the physical medium.
<i>txqueuelen</i>	The current length of the transmission queue for the interface.
<i>RX/TX bytes</i>	The total volume of data in bytes received (RX) and transmitted (TX).

Table 14: Interface parameter descriptions

## Routing Tables

The middle of the page shows the kernel routing tables. Both the IPv4 *Route Table* and the IPv6 *Route Table* are displayed. Below the main routing tables, the *Backup Routes* section lists any currently active backup routes.

If NAT64 is enabled (in *Configuration* → *NAT* → *IPv6*), it is automatically used for communication between IPv6 and IPv4 networks. This works with the router's DNS64 service, which synthesizes AAAA records from A records. When active, a route for the default NAT64 prefix, `64:ff9b::/96`, will be visible in the *IPv6 Route Table*, as shown in Figure 6.

## Backup Routes

This section identifies the active primary WAN interface and its corresponding IP address for both IPv4 and IPv6 Internet traffic. The status shown here directly reflects the router's automatic failover system (detailed in Chapter 3.7 *Backup Routes*), which operates independently of the main routing table. When the primary connection fails, the router automatically switches to a backup interface, and that change is immediately displayed here. The table below describes the status parameters displayed in this section:

Parameter	Description
WAN IP Interface	Displays the network interface (e.g., eth0, usb0) currently providing the primary outbound path for all IPv4 traffic. If no connection is active, this shows N/A.
WAN IP Address	Displays the current IPv4 address assigned to the active WAN interface.
WAN IPv6 Interface	Displays the network interface currently providing the primary outbound path for all IPv6 traffic. If no connection is active, this shows N/A.
WAN IPv6 Address	Displays the current IPv6 address assigned to the active WAN IPv6 interface.

Table 15: Backup routes status parameters

## LLDP Neighbors

This section displays information about directly connected network devices discovered via the Link Layer Discovery Protocol (LLDP). For this section to be populated, the LLDP service must be enabled in the router's configuration (detailed in Chapter 3.18.4 *LLDP*).

By default, the page provides a concise summary of all detected neighbors, displaying essential information such as the local interface, the neighbor's MAC address ( `ChassisID` ), system name ( `SysName` ), and basic port details. To view extensive diagnostic data for these devices—such as hardware descriptions, management IP addresses, device capabilities, and Power over Ethernet (PoE/MDI) parameters—click the » *More Information* « link at the bottom of the list. The following example shows the extended information belonging to an Advantech ICR-3232 router:

```
Interface: eth1, via: LLDP, RID: 2, Time: 0 day, 01:03:07
Chassis:
  ChassisID: mac 00:11:22:33:44:55
  SysName: Router
  SysDescr: ICR-323x 6.6.1 (2026-02-11, commit 2f2ad43db9b08bc71c5d5efe0cf64dfdb0910ff1) #3559
  MgmtIP: 192.168.1.10
  MgmtIface: 9
  MgmtIP: fe80::85f:aff:febc:7b1e
  MgmtIface: 11
  Capability: Bridge, off
  Capability: Router, on
  Capability: Wlan, off
  Capability: Station, off
Port:
  PortID: mac 00:11:22:33:44:55
  PortDescr: eth0
  TTL: 20
  PMD autoneg: supported: yes, enabled: yes
  Adv: 10Base-T, HD: yes, FD: yes
  Adv: 100Base-TX, HD: yes, FD: yes
  MAU oper type: 100BaseTXFD - 2 pair category 5 UTP, full duplex mode
```

### Info

The structure and meaning of LLDP data units (TLVs) are defined by the **IEEE 802.1AB** standard. For more information about the protocol, visit the official IEEE 802.1 working group page at [ieee802.org/1/pages/802.1ab.html](http://ieee802.org/1/pages/802.1ab.html). Full versions of IEEE standards are typically accessible through the *IEEE GET program*.

## 2.5 DHCP

To view information about DHCP server activity, navigate to *Status* → *DHCP*. The router's DHCP server automatically provides network configuration to client devices. For each client, it assigns an IP address, subnet mask, default gateway, and DNS server. The router supports both DHCPv4 and DHCPv6 servers.

The *DHCP Status* page lists all active IP address leases, grouped by the interface they are associated with (e.g., *LAN*, *WiFi AP 1*). If no leases are active on an interface or the server is disabled for that interface, a corresponding message is displayed.

DHCP Status					refresh
Active DHCP Leases (LAN)					
IPv4 Address	Lease Starts	Lease Ends	MAC	Hostname	
192.168.2.2	2022-06-14 11:16:30	2022-06-14 11:26:30	aa:bb:cc:dd:ee:ff	"PETA-NB"	
IPv6 Address	Lease Starts	Lease Ends	IA-NA		
2001:db8::10	2022-06-14 11:20:27	2022-06-14 11:30:27	\235{P\006\000\001\000\001%y\030DP{\235\246SK		
Active DHCP Leases (WiFi AP 1)					
IPv4 Address	Lease Starts	Lease Ends	MAC	Hostname	
192.168.2.2	2022-06-14 11:30:55	2022-06-14 11:40:55	aa:bb:cc:dd:ee:ff	"Galaxy-S10"	
No active dynamic DHCPv6 Leases.					
Active DHCP Leases (WiFi AP 2)					
DHCP server is disabled.					

Figure 7: DHCP status page

The table below describes the information provided for each active lease.

Column	Description
<i>IPv4 Address</i>	The IPv4 address assigned to the client.
<i>IPv6 Address</i>	The IPv6 address assigned to the client.
<i>Lease Starts</i>	The date and time when the IP address lease began.
<i>Lease Ends</i>	The date and time when the IP address lease will expire.
<i>MAC</i>	The unique MAC address of the client device (applies to IPv4 leases).
<i>Hostname</i>	The hostname of the client device (applies to IPv4 leases).
<i>IA-NA</i>	Identity Association for Non-temporary Addresses. A unique DHCPv6 identifier for the client's address assignment (applies to IPv6 leases).

Table 16: DHCP status column descriptions

### Info

The DHCP status may occasionally display two records for one IP address. This can be caused by a client's network interface being reset.

## 2.6 IPsec

To check the status of configured IPsec tunnels, navigate to the *Status* → *IPsec* page. This page displays a log of the IPsec connection status.

For a successfully established tunnel, the log will contain the keyword **ESTABLISHED**. Additionally, the status summary will show the number of active connections, such as **1 up**, as highlighted in the figure below.

If the log does not show these indicators (e.g., it shows **0 up**), the IPsec tunnel has not been successfully established.

The screenshot shows the 'IPsec Status' page with a 'refresh' button in the top right. The main content is titled 'IPsec Tunnels Information' and displays the following text:

```
Status of IKE charon daemon (weakSwan 5.5.3, Linux 3.12.10+, armv7l):
uptime: 26 minutes, since Nov 09 10:26:10 2017
malloc: sbrk 528384, mmap 0, used 123104, free 405280
worker threads: 11 of 16 idle, 5/0/0/0 working, job queue: 0/0/0/0, scheduled: 5
loaded plugins: charon nonce pem openssl kernel-netlink socket-default stroke updown
Listening IP addresses:
192.168.1.1
2001:10:7:6::1
10.0.0.228
Connections:
ipsecl: 10.0.0.228...%any IKEv2, dpddelay=20s
ipsecl: local: [10.0.0.228] uses pre-shared key authentication
ipsecl: remote: uses pre-shared key authentication
ipsecl: child: 2001:10:7:6::/64 === 1999:10:7:5::/64 TUNNEL, dodaction=clear
Security Associations (1 up, 0 connecting):
ipsecl[2]: ESTABLISHED 17 minutes ago, 10.0.0.228[10.0.0.228]...10.0.2.250[10.0.2.250]
ipsecl[2]: IKEv2 SPIs: 7e675f07f05d7434_i 8625de2fc6f84049_r*, pre-shared key reauthentication in 28 minutes
ipsecl[2]: IKE proposal: AES_CBC_128/HMAC_SHA2_256_128/PRF_HMAC_SHA2_256/MOOP_3072
ipsecl{2}: INSTALLED, TUNNEL, reqid 2, ESP SPIs: c7247a03_i c29f5287_o
ipsecl{2}: AES_CBC_128/HMAC_SHA1_96, 0 bytes_i, 0 bytes_o, rekeying in 30 minutes
ipsecl{2}: 2001:10:7:6::/64 === 1999:10:7:5::/64
```

The line 'ipsecl[2]: ESTABLISHED 17 minutes ago, 10.0.0.228[10.0.0.228]...10.0.2.250[10.0.2.250]' is highlighted with a red box.

Figure 8: IPsec status

## 2.7 WireGuard

To check the status of configured WireGuard tunnels, navigate to the *Status* → *WireGuard* page. This page displays the current operational state and statistics for each active WireGuard interface.

The figure below shows an example of a running WireGuard tunnel.

The screenshot shows a web interface titled "WireGuard Tunnel Status" with a "refresh" button. It displays four sections for tunnel information:

- 1st WireGuard Tunnel Information:** Shows an active tunnel for interface `wg1`. It lists the public key `Zu5pZz4h05xUDGvcFN9ULr2W0oxzcL6V4Hi+WkyE63E=`, a hidden private key, and a listening port of `51820`. A peer is connected with endpoint `192.168.7.231:51820`, allowed IPs `10.0.0.0/30, 192.168.133.0/24`, a latest handshake of `1 minute, 55 seconds ago`, and a transfer of `1.44 KiB received, 5.28 KiB sent`. The persistent keepalive is set to `every 25 seconds`.
- 2nd WireGuard Tunnel Information:** Displays `WireGuard is disabled.`
- 3rd WireGuard Tunnel Information:** Displays `WireGuard is disabled.`
- 4th WireGuard Tunnel Information:** Displays `WireGuard is disabled.`

Figure 9: WireGuard status page

The status page displays the following information for each peer connected to a WireGuard interface.

Parameter	Description
<i>Interface</i>	The name of the WireGuard interface on the router (e.g., <code>wg0</code> ).
<i>Public key</i>	The public key of the connected peer.
<i>Allowed ips</i>	The IP addresses from which this peer is allowed to send traffic through the tunnel.
<i>Latest handshake</i>	The time elapsed since the last successful handshake with the peer. A handshake confirms a secure connection. This time is only displayed after data has been exchanged, either from regular traffic or a keepalive packet (if enabled).
<i>Transfer</i>	The total amount of data received (rx) and transmitted (tx) through the tunnel for this peer.

Table 17: WireGuard status parameter descriptions

## 2.8 Dynamic DNS

The Dynamic DNS service allows you to access your router using a fixed domain name even when its public IP address changes. To view the service’s current status, navigate to the *Status* → *Dynamic DNS* page.

### Warning



For the Dynamic DNS service to function correctly, the router’s mobile connection must be assigned a public IP address by your cellular provider.

The router is compatible with several third-party Dynamic DNS providers and supports standard update protocols, including DynDNS (HTTP API) and DDNS (RFC 2136). You can configure the service to use providers such as:

- [freedns.afraid.org](http://freedns.afraid.org)
- [www.duckdns.org](http://www.duckdns.org)
- [www.noip.com](http://www.noip.com)

IPv6 updates can be used when *IP Mode* is set to *IPv6* on the *Services* → *Dynamic DNS* configuration page. The status page displays messages that indicate the current state of the Dynamic DNS client and its communication with the provider.

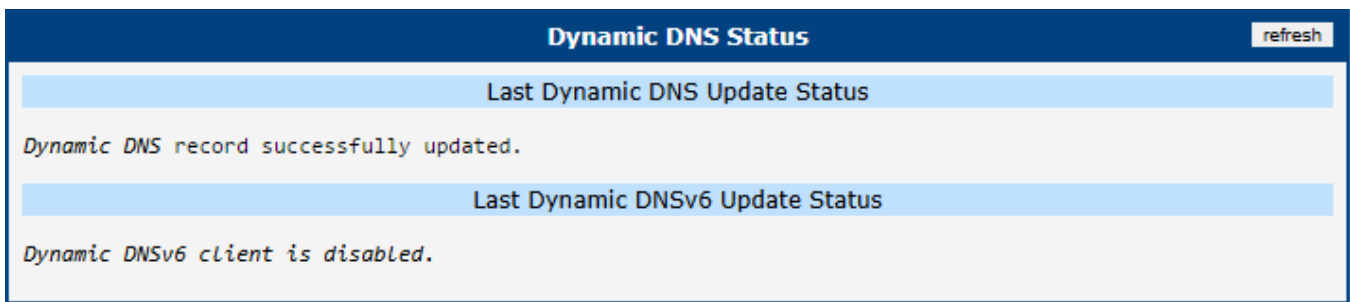

Figure 10: Dynamic DNS status page

The table below lists the possible messages you may encounter.

Status Message
Dynamic DNS client is disabled.
Invalid username or password.
Specified hostname doesn’t exist.
Invalid hostname format.
Hostname exists, but not under specified username.
No update performed since startup.
DNS error encountered.
DynDNS record is already up to date.
DynDNS record successfully updated.
DynDNS system parametr is not valid.
DynDNS server failure.
Last reported IP was [IP address] on [datetime].
Last report to Dynamic DNS server is unknown.
Dynamic DNSv6 client is disabled.

Table 18: Dynamic DNS status messages

## 2.9 Connections

The *Status* → *Connections* page displays a real-time list of all active network connections passing through the router. This overview is particularly useful for monitoring current network traffic and troubleshooting routing or connectivity issues.

Connections				
Protocol	Source Address	Source Port	Destination Address	Destination Port
tcp	10.64.0.1	49566	10.64.0.130	443
tcp	10.64.0.1	49565	10.64.0.130	443
tcp	10.64.0.1	49557	10.64.0.130	443
tcp	10.64.0.1	49563	10.64.0.130	443
tcp	10.64.0.1	49564	10.64.0.130	443
tcp	10.64.0.1	49559	10.64.0.130	443
tcp	10.64.0.1	49570	10.64.0.130	443
tcp	10.64.0.1	49569	10.64.0.130	443
tcp	10.64.0.1	49561	10.64.0.130	443
tcp	10.64.0.1	49560	10.64.0.130	443
tcp	10.64.0.1	49553	10.64.0.130	443
tcp	10.64.0.1	49571	10.64.0.130	443
tcp	10.64.0.1	49567	10.64.0.130	443
tcp	10.64.0.1	49572	10.64.0.130	443
tcp	10.64.0.1	49568	10.64.0.130	443
tcp	10.64.0.1	49562	10.64.0.130	443

Figure 11: List of active network connections

The table below describes the information provided in each column of the connections list.

Column	Description
<i>Protocol</i>	The transport layer protocol used for the connection (e.g., TCP, UDP, or ICMP).
<i>Source Address</i>	The originating IP address of the network connection.
<i>Source Port</i>	The originating port number of the connection.
<i>Destination Address</i>	The target IP address of the network connection.
<i>Destination Port</i>	The target port number of the connection.

Table 19: Description of columns in the connections list

## 2.10 Router Apps

The *Status* → *Router Apps* page provides a quick overview of all Router Apps currently installed on the router. This summary allows administrators to easily verify the operational state of each application without needing to navigate to the primary configuration menu of every single Router App.

As shown in the figure below, the page lists each installed Router App and clearly indicates its current status (e.g., whether the application is actively running or currently stopped).

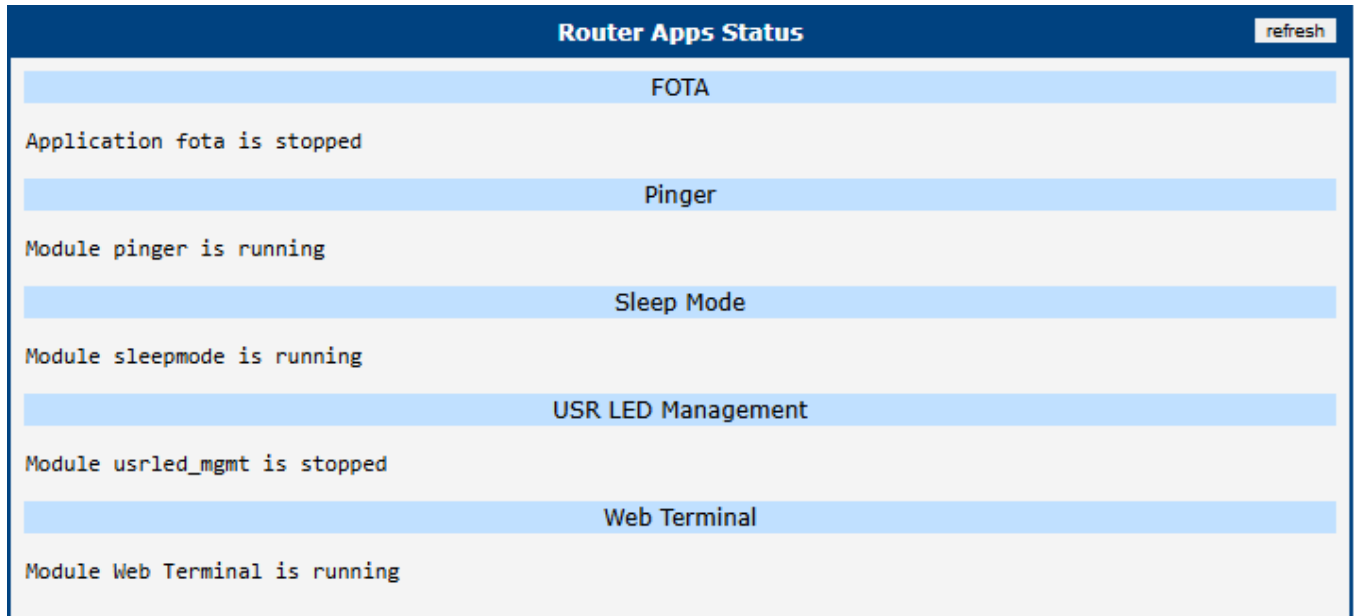

Router Apps Status <span>refresh</span>	
FOTA	Application fota is stopped
Pinger	Module pinger is running
Sleep Mode	Module sleepmode is running
USR LED Management	Module usrled_mgmt is stopped
Web Terminal	Module Web Terminal is running

Figure 12: Router Apps status page

## 2.11 System Log

To view the router's operational logs, navigate to the *Status* → *System Log* page. This page displays messages generated by the router's operating system and various services.

### Info

For security, sensitive data such as passwords is automatically filtered out from the system log and diagnostic reports.

The level of detail in the log is controlled by the *Minimum Severity* setting on the *Configuration* → *Services* → *Syslog* page.

The router manages log storage to prevent files from growing indefinitely. By default, the total log size is limited to 10 KiB, split between two rotating files. When the current file is full, the system switches to the other. Once both are full, new entries overwrite the oldest ones. The *Log Size Limit* can be adjusted on the Syslog configuration page.

The *System Log* page provides several options for downloading diagnostic information:

- **Save Log:** Downloads the current contents of the system log as a plain text file ( `*.log` ).
- **Save Report:** Generates and downloads a comprehensive diagnostic report file ( `*.txt` ), which is essential for troubleshooting and providing to technical support. The report always contains the following information:
  - General system information and status
  - Network statistics and current routing tables
  - A list of all running processes
  - Filesystem usage information
  - The complete system log

**Note:** For users logged in with the *Admin* role, the report will additionally include a copy of the current (non-sensitive) router configuration. This section is omitted for standard users.

- **Save Diagnostic Data:** Downloads a compressed archive ( `*.gz` ) containing detailed data from the last system failure. This button is **only visible to users with the Admin role** and is only enabled when a system crash dump is present. The data is intended for advanced analysis by technical support.

The screenshot shows the 'System Log' page with a 'refresh' button in the top right. Below the title is a section for 'System Messages' containing a list of log entries. At the bottom of the page are three buttons: 'Save Log', 'Save Report', and 'Save Diagnostic Data'.

```

System Log
refresh

System Messages

2013-07-02 12:46:19 pppsd[426]: module is turned on
2013-07-02 12:46:19 pppsd[426]: selected SIM: 1st
2013-07-02 12:46:19 dnsmasq[453]: started, version 2.59 cachesize 150
2013-07-02 12:46:19 dnsmasq[453]: cleared cache
2013-07-02 12:46:19 bard[455]: bard started
2013-07-02 12:46:19 pppsd[426]: selected APN: connection.com
2013-07-02 12:46:19 pppsd[426]: waiting for registration
2013-07-02 12:46:20 pppsd[426]: starting usbd
2013-07-02 12:46:20 usbd[500]: usbd started
2013-07-02 12:46:20 usbd[500]: establishing connection
2013-07-02 12:46:20 sshd[506]: Server listening on 0.0.0.0 port 22.
2013-07-02 12:46:29 usbd[500]: connection established
2013-07-02 12:46:29 usbd[500]: local IP address 10.0.1.229
2013-07-02 12:46:29 usbd[500]: primary DNS address 10.0.0.1
2013-07-02 12:46:29 bard[455]: backup route selected: "Mobile WAN"

Save Log Save Report Save Diagnostic Data
  
```

Figure 13: System log page

# 3. Configuration

## 3.1 Ethernet

To configure the Local Area Network (LAN), navigate to the *Ethernet* menu item in the *Configuration* section. Expanding the *Ethernet* menu on the left allows you to select the appropriate Ethernet interface for configuration: *ETH0* for the first Ethernet interface and *ETH1* for the second Ethernet interface.

This configuration page is divided into IPv4 and IPv6 sections. The router supports dual-stack operation, meaning IPv4 and IPv6 can run concurrently. You can configure either one or both. When both IPv4 and IPv6 are enabled, network devices automatically select the appropriate protocol. The configuration options for IPv4 and IPv6 are described in the following tables.

ETH0 Configuration			
<input checked="" type="checkbox"/> Enable Port			
	IPv4	IPv6	
DHCP Client	disabled	disabled	
IP Address	192.168.1.1		
Subnet Mask / Prefix	255.255.255.0		
Default Gateway			
Primary DNS Server			
Secondary DNS Server			
Bridged	no		
MTU	1500	bytes	576-1500 bytes
Media Type	auto-negotiation		
<input checked="" type="checkbox"/> Enable dynamic DHCP leases			
	IPv4	IPv6	
IP Pool Start	192.168.1.2		
IP Pool End	192.168.1.254		
Lease Time	600	600	sec
<input type="checkbox"/> Enable static DHCP leases			
	MAC Address	IP Address	IPv6 Address
1			
2			
Maximum 32 items			
<input type="checkbox"/> Enable IPv6 prefix delegation			
Subnet ID *			
Subnet ID Width *			bits

Figure 14: LAN configuration page

Enable IPv6 prefix delegation

Subnet ID \*

Subnet ID Width \*  bits

---

Enable IEEE 802.1X Authentication

Authentication Method

CA Certificate

No file chosen

Local Certificate

No file chosen

Local Private Key

No file chosen

Identity

Password

\* can be blank

Figure 15: LAN configuration page

Item	Description
<i>Enable Port</i>	Enables or disables the physical Ethernet port.
<i>DHCP Client</i>	Enables or disables the DHCP client function. In the IPv6 column, this enables the DHCPv6 client, which supports all three methods of obtaining an IPv6 address: SLAAC, stateless DHCPv6, and stateful DHCPv6. <ul style="list-style-type: none"> <li>• <b>disabled</b> – The router will not request an IP address from a DHCP server on the LAN.</li> <li>• <b>enabled</b> – The router will request an IP address from a DHCP server on the LAN.</li> </ul>
<i>IP Address</i>	Sets a static IP address for the Ethernet interface. Use standard IPv4 or IPv6 notation (shortened notation is supported for IPv6).
<i>Subnet Mask / Prefix</i>	Specifies the subnet mask for a static IPv4 address or the prefix length for a static IPv6 address (a number from 0 to 128).
<i>Default Gateway</i>	Specifies the IP address of the default gateway. Packets with a destination not found in the routing table will be sent to this gateway.
<i>Primary DNS Server</i>	Specifies the IP address of the primary DNS server.
<i>Secondary DNS Server</i>	Specifies the IP address of the secondary DNS server.

Table 20: Network interface example – IPv4 and IPv6

The *Default Gateway* and *DNS Server* settings are only used if the *DHCP Client* is set to *disabled* and the corresponding LAN interface (ETH0 or ETH1) is selected as the default route by the *Backup Routes* system (see Chapter 3.7 *Backup Routes*).

The following three items are global for the configured Ethernet interface. Only one bridge can be active on the router at a time. When a bridge is created, the *DHCP Client*, *IP Address*, and *Subnet Mask / Prefix* parameters are taken from the member interface with the lowest index (e.g., ETH0 has priority over ETH1). Other interfaces can be added to or removed from an existing bridge at any time.

### Warning

Under certain conditions, an Ethernet interface can operate as a WAN interface, in which case firewall rules will apply. For details and examples, see Chapter 3.7 *Backup Routes*.

Item	Description
<i>Bridged</i>	Activates or deactivates bridging for this interface. <ul style="list-style-type: none"> <li>• <b>no</b> – Bridging is inactive (default).</li> <li>• <b>yes</b> – Bridging is active.</li> </ul> See the <b>Bridge Notes</b> below for more details.
<i>MTU</i>	Sets the Maximum Transmission Unit (MTU) value. The default is 1500 bytes.
<i>Media Type</i>	Specifies the duplex mode and speed for the Ethernet port. <ul style="list-style-type: none"> <li>• <b>Auto-negotiation</b> – The router automatically determines the optimal speed and duplex mode (default).</li> <li>• <b>100 Mbps Full Duplex</b> – Sets a speed of 100 Mbps with full-duplex communication.</li> <li>• <b>100 Mbps Half Duplex</b> – Sets a speed of 100 Mbps with half-duplex communication.</li> <li>• <b>10 Mbps Full Duplex</b> – Sets a speed of 10 Mbps with full-duplex communication.</li> <li>• <b>10 Mbps Half Duplex</b> – Sets a speed of 10 Mbps with half-duplex communication.</li> </ul>

Table 21: Network interface global items

### Bridge Notes

A bridge functions like a network switch, forwarding packets between the interfaces connected to it. Advantech routers support bridging between Ethernet interfaces or between Ethernet and Wi-Fi Access Point (AP) interfaces. When a bridge is established, a new virtual interface named `br0` is created, which is visible on the *Status* → *Network* → *Interfaces* page.

If two Ethernet interfaces are bridged, the `br0` interface inherits the IP configuration of the interface with the lower index (e.g., `ETH0` over `ETH1`), and the configuration of the higher-indexed interface is disregarded. To include a Wi-Fi AP in a bridge, at least one Ethernet interface must also be a member; the bridge IP will be determined by the Ethernet interface.

#### 3.1.1 DHCP Server

The DHCP server assigns IP addresses, a gateway IP (the router’s IP), and a DNS server IP (the router’s IP) to connected clients. It supports both static and dynamic IP address assignment. *Dynamic DHCP* assigns IPs from a configured address pool, while *Static DHCP* assigns specific IPs to clients based on their MAC addresses.



#### Info

- In the IPv6 column, these settings configure the DHCPv6 server. It provides stateful address configuration to clients. If the LAN prefix is set to /64, the server will also offer Stateless Address Autoconfiguration (SLAAC).
- For DHCPv6 static assignments to work, the client must use a DUID-LL or DUID-LLT type, which is derived from its MAC address.



#### Warning

Do not overlap the IP address ranges for static and dynamic DHCP leases. Doing so can cause IP address conflicts and network instability.

Item	Description
<i>Enable dynamic DHCP leases</i>	Enables the dynamic DHCP server.
<i>IP Pool Start</i>	The starting IP address of the range to be allocated to DHCP clients.
<i>IP Pool End</i>	The ending IP address of the range to be allocated to DHCP clients.
<i>Lease Time</i>	The duration (in seconds) for which an assigned IP address is valid before it can be reassigned.

Table 22: Dynamic DHCP server configuration

Item	Description
<i>Enable static DHCP leases</i>	Enables the static DHCP server. You can define up to 32 rules; a new row appears automatically after you fill in the previous one.
<i>MAC Address</i>	The MAC address of the DHCP client.
<i>IPv4 Address</i>	The IPv4 address to be assigned to the client.
<i>IPv6 Address</i>	The IPv6 address to be assigned to the client.

Table 23: Static DHCP server configuration

### 3.1.2 IPv6 Prefix Delegation

#### Warning



This is an advanced feature. IPv6 prefix delegation works automatically with DHCPv6. Only use this section if you require a non-standard configuration and understand the implications.

If you need to override the automatic IPv6 prefix delegation, you can configure it here. You must specify the Subnet ID Width. For example, in a typical /48 site prefix, the 16 bits following the site prefix are the Subnet ID, and the final 64 bits are the Interface ID.

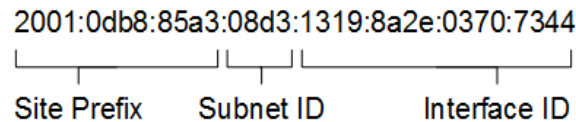

Figure 16: Example of an IPv6 address with prefix

Item	Description
<i>Enable IPv6 prefix delegation</i>	Enables the manual prefix delegation configuration below.
<i>Subnet ID</i>	The decimal value of the Subnet ID for the Ethernet interface. The maximum value depends on the <i>Subnet ID Width</i> .
<i>Subnet ID Width</i>	The bit-width of the Subnet ID field. This value is typically the remainder of 64 minus the site prefix length.

Table 24: IPv6 prefix delegation configuration

### 3.1.3 802.1X Authentication with RADIUS Server

**IEEE 802.1X** is an IEEE standard for **port-based Network Access Control** (PNAC). It provides an authentication mechanism for devices connecting to a LAN or WLAN using "EAP over LAN" (**EAPoL**), which encapsulates the **Extensible Authentication Protocol** (EAP).

IEEE 802.1X involves three parties: a **supplicant**, an **authenticator**, and an **authentication server**, as shown in Figure 17.

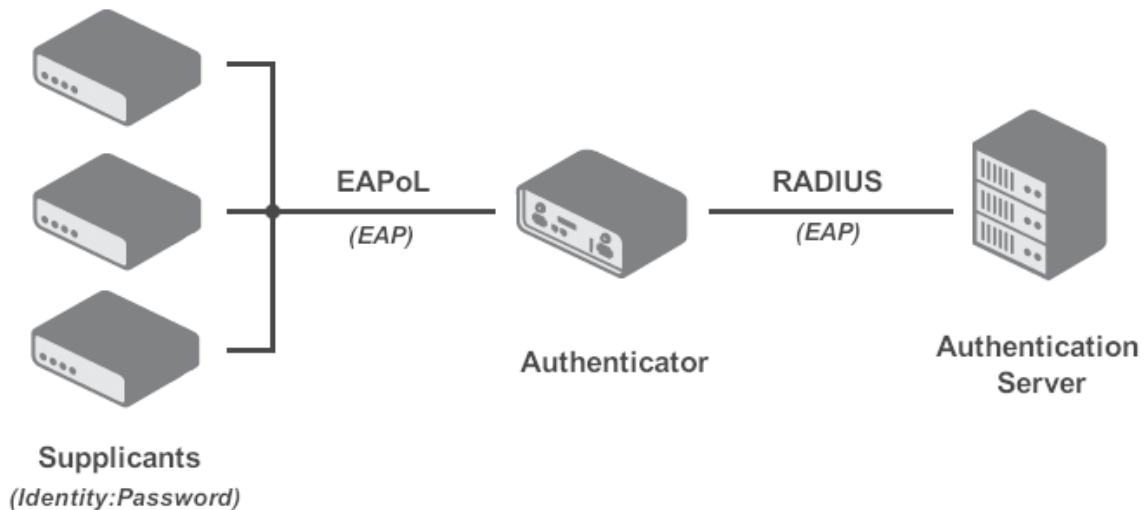

Figure 17: IEEE 802.1X functional diagram

- The **supplicant** is a client device (e.g., a laptop) requesting network access.
- The **authenticator** is a network device (e.g., a switch or router) that controls network access and mediates communication with the authentication server.
- The **authentication server** (typically a **RADIUS** server) validates the supplicant's credentials and authorizes or denies access.

Table 25 summarizes the supported 802.1X roles on Advantech routers.

### Info

Advantech routers can function as a supplicant or an authenticator, but not as an authentication server.

Interface	Supplicant Role	Authenticator Role
LAN	Supported as a built-in feature (see Chapter ).	Supported via the <i>802.1X Authenticator Router App</i> .
Wi-Fi	Supported in Station (STA) mode (see Chapter <i>3.6.2 Station</i> ).	Supported in Access Point (AP) mode (see Chapter <i>3.6.1 Access Point</i> ).

Table 25: Supported roles for IEEE 802.1X authentication

The 802.1X supplicant can be enabled in the section below. This requires configuring an identity and, for EAP-TLS, certificates.

Item	Description
<i>Enable IEEE 802.1X Authentication</i>	Enables the 802.1X supplicant on this interface.
<i>Authentication Method</i>	Selects the authentication method (EAP-PEAP/MSCHAPv2 or EAP-TLS).
<i>CA Certificate</i>	Defines the CA certificate for the EAP-TLS protocol.
<i>Local Certificate</i>	Defines the local certificate for the EAP-TLS protocol.
<i>Local Private Key</i>	Defines the local private key for the EAP-TLS protocol.
<i>Identity</i>	The username (identity) for authentication.
<i>Password</i>	The password for authentication (used only for EAP-PEAP/MSCHAPv2).
<i>Local Private Key Password</i>	The password for the local private key (used only for EAP-TLS).

Table 26: 802.1X authentication configuration

### 3.1.4 LAN Configuration Examples

#### Example 1: Dynamic DHCP with Custom Gateway and DNS

- The dynamic IPv4 address pool is 192.168.1.2 to 192.168.1.4.
- The lease time is 600 seconds (10 minutes).
- The default gateway IP address is 192.168.1.20.
- The DNS server IP address is 192.168.1.20.

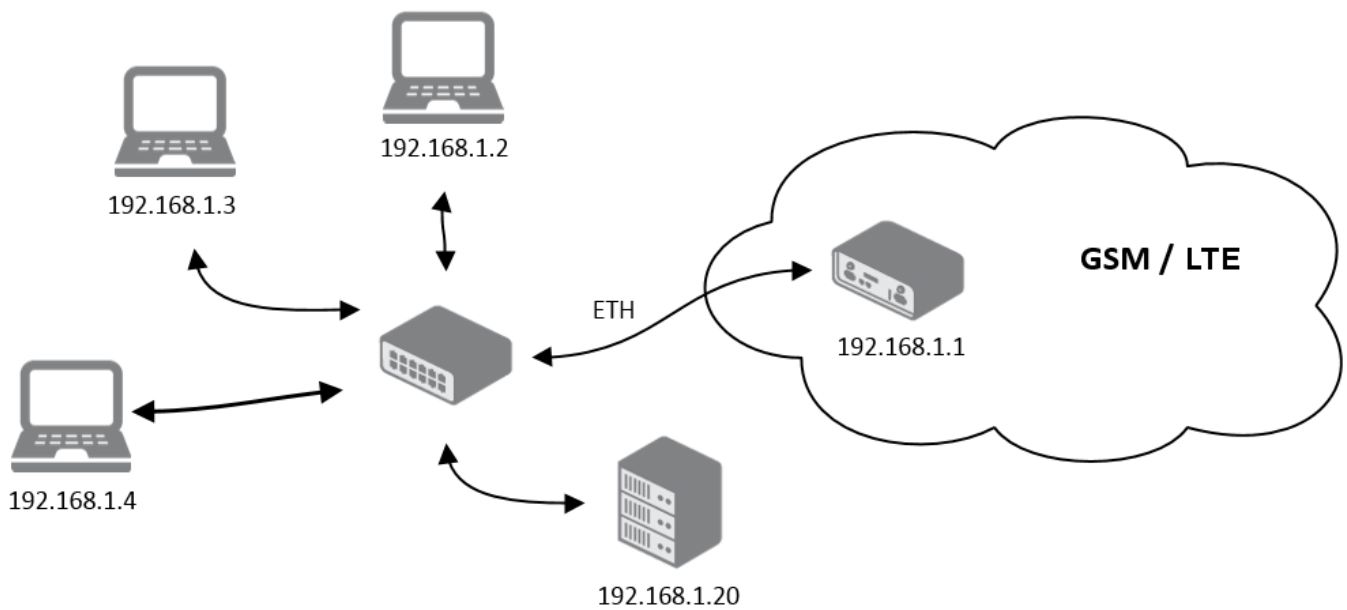

Figure 18: Network topology for example 1

ETH1 Configuration			
<input checked="" type="checkbox"/> Enable Port			
	IPv4	IPv6	
DHCP Client	<input type="text" value="disabled"/>	<input type="text" value="disabled"/>	
IP Address	<input type="text" value="192.168.1.1"/>	<input type="text"/>	
Subnet Mask / Prefix	<input type="text" value="255.255.255.0"/>	<input type="text"/>	
Default Gateway	<input type="text" value="192.168.1.20"/>	<input type="text"/>	
Primary DNS Server	<input type="text" value="192.168.1.20"/>	<input type="text"/>	
Secondary DNS Server	<input type="text"/>	<input type="text"/>	
Bridged	<input type="text" value="no"/>		
MTU	<input type="text" value="1500"/>	bytes	576-1500 bytes
Media Type	<input type="text" value="auto-negotiation"/>		
<input checked="" type="checkbox"/> Enable dynamic DHCP leases			
	IPv4	IPv6	
IP Pool Start	<input type="text" value="192.168.1.2"/>	<input type="text"/>	
IP Pool End	<input type="text" value="192.168.1.4"/>	<input type="text"/>	
Lease Time	<input type="text" value="600"/>	<input type="text" value="600"/>	sec 5-86400 sec
<input type="checkbox"/> Enable static DHCP leases			
	MAC Address	IP Address	IPv6 Address
1	<input type="text"/>	<input type="text"/>	<input type="text"/>
2	<input type="text"/>	<input type="text"/>	<input type="text"/>
Maximum 32 items			
<input type="checkbox"/> Enable IPv6 prefix delegation			
Subnet ID *	<input type="text"/>		
Subnet ID Width *	<input type="text"/>	bits	8-32 bits
<input type="checkbox"/> Enable IEEE 802.1X Authentication			
Authentication Method	<input type="text" value="EAP-PEAP/MSCHAPv2"/>		
CA Certificate	<input type="text"/>		
	<input type="button" value="Choose File"/> No file chosen		
Local Certificate	<input type="text"/>		
	<input type="button" value="Choose File"/> No file chosen		
Local Private Key	<input type="text"/>		
	<input type="button" value="Choose File"/> No file chosen		
Identity	<input type="text"/>		
Password	<input type="text"/>		
* can be blank			
<input type="button" value="Apply"/>			

Figure 19: LAN configuration for example 1

**Example 2: Dynamic and Static DHCP Server**

- The dynamic address pool is 192.168.1.2 to 192.168.1.4.
- The lease time is 600 seconds (10 minutes).
- The client with MAC 01:23:45:67:89:ab is assigned the static IP 192.168.1.10.
- The client with MAC 01:54:68:18:ba:7e is assigned the static IP 192.168.1.11.

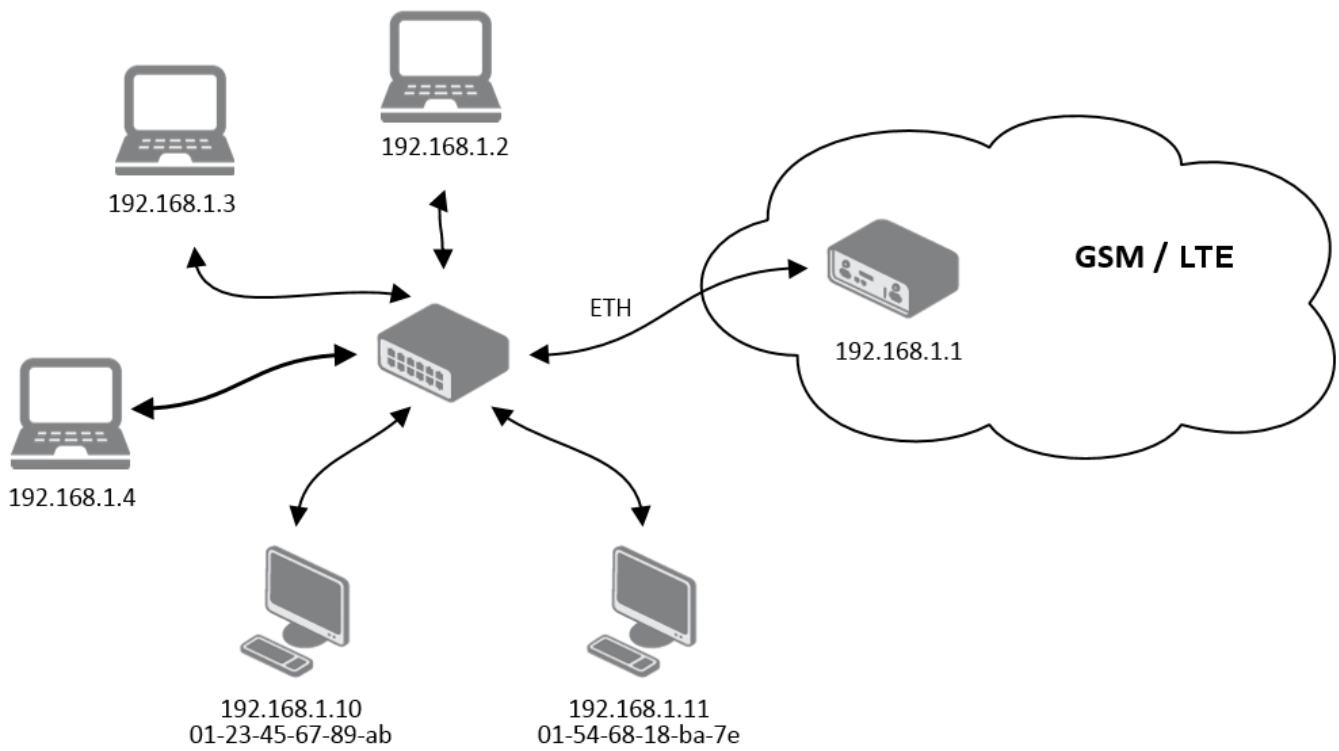

Figure 20: Network topology for example 2

**ETH1 Configuration**

**Enable Port**

	IPv4	IPv6	
DHCP Client	<input type="text" value="disabled"/>	<input type="text" value="disabled"/>	
IP Address	<input type="text" value="192.168.1.1"/>	<input type="text"/>	
Subnet Mask / Prefix	<input type="text" value="255.255.255.0"/>	<input type="text"/>	
Default Gateway	<input type="text"/>	<input type="text"/>	
Primary DNS Server	<input type="text"/>	<input type="text"/>	
Secondary DNS Server	<input type="text"/>	<input type="text"/>	

---

Bridged

MTU  bytes 576-1500 bytes

Media Type

---

**Enable dynamic DHCP leases**

	IPv4	IPv6	
IP Pool Start	<input type="text" value="192.168.1.2"/>	<input type="text"/>	
IP Pool End	<input type="text" value="192.168.1.4"/>	<input type="text"/>	
Lease Time	<input type="text" value="600"/>	<input type="text" value="600"/>	sec <span style="float: right;">5-86400 sec</span>

---

**Enable static DHCP leases**

	MAC Address	IP Address	IPv6 Address
1	<input type="text" value="01:23:45:67:89:ab"/>	<input type="text" value="192.168.1.10"/>	<input type="text"/>
2	<input type="text" value="01:54:68:18:ba:7e"/>	<input type="text" value="192.168.1.11"/>	<input type="text"/>

Maximum 32 items

---

**Enable IPv6 prefix delegation**

Subnet ID \*

Subnet ID Width \*  bits 8-32 bits

---

**Enable IEEE 802.1X Authentication**

Authentication Method

CA Certificate

No file chosen

Local Certificate

No file chosen

Local Private Key

No file chosen

Identity

Password

---

*\* can be blank*

Figure 21: LAN configuration for example 2

**Example 3: IPv6 Dynamic DHCP Server**

- The dynamic IPv6 address pool is 2001:db8::1 to 2001:db8::ffff.
- The lease time is 600 seconds (10 minutes).
- The router remains accessible via its default IPv4 address (192.168.1.1).

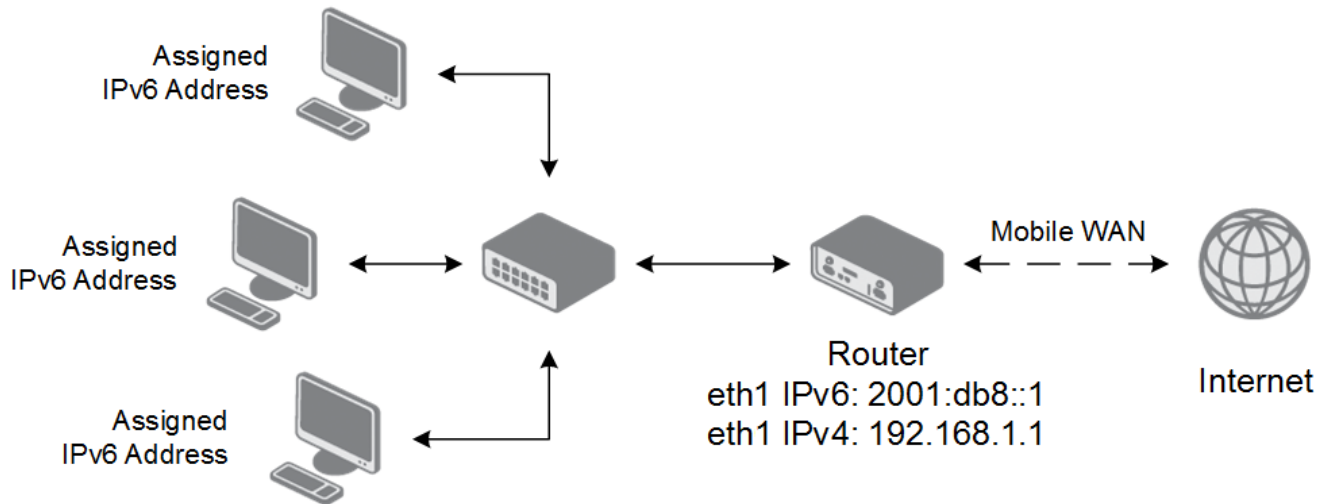

Figure 22: Network topology for example 3

ETH1 Configuration			
<input checked="" type="checkbox"/> Enable Port			
	IPv4	IPv6	
DHCP Client	<input type="text" value="disabled"/>	<input type="text" value="disabled"/>	
IP Address	<input type="text" value="192.168.1.1"/>	<input type="text" value="2001:db8::1"/>	
Subnet Mask / Prefix	<input type="text" value="255.255.255.0"/>	<input type="text" value="64"/>	
Default Gateway	<input type="text"/>	<input type="text"/>	
Primary DNS Server	<input type="text"/>	<input type="text"/>	
Secondary DNS Server	<input type="text"/>	<input type="text"/>	
Bridged	<input type="text" value="no"/>		
MTU	<input type="text" value="1500"/>	bytes	576-1500 bytes
Media Type	<input type="text" value="auto-negotiation"/>		
<input checked="" type="checkbox"/> Enable dynamic DHCP leases			
	IPv4	IPv6	
IP Pool Start	<input type="text"/>	<input type="text" value="2001:db8::2"/>	
IP Pool End	<input type="text"/>	<input type="text" value="2001:db8::fff"/>	
Lease Time	<input type="text"/>	<input type="text" value="600"/>	sec 5-86400 sec
<input type="checkbox"/> Enable static DHCP leases			
	MAC Address	IP Address	IPv6 Address
1	<input type="text"/>	<input type="text"/>	<input type="text"/>
2	<input type="text"/>	<input type="text"/>	<input type="text"/>
Maximum 32 items			
<input type="checkbox"/> Enable IPv6 prefix delegation			
Subnet ID *	<input type="text"/>		
Subnet ID Width *	<input type="text"/>	bits	8-32 bits
<input type="checkbox"/> Enable IEEE 802.1X Authentication			
Authentication Method	<input type="text" value="EAP-PEAP/MSCHAPv2"/>		
CA Certificate	<input type="text"/>		
	<input type="button" value="Choose File"/> No file chosen		
Local Certificate	<input type="text"/>		
	<input type="button" value="Choose File"/> No file chosen		
Local Private Key	<input type="text"/>		
	<input type="button" value="Choose File"/> No file chosen		
Identity	<input type="text"/>		
Password	<input type="text"/>		
* can be blank			
<input type="button" value="Apply"/>			

Figure 23: LAN configuration for example 3

## 3.2 VLAN

The router allows for the creation of up to three separate Virtual LAN (VLAN) interfaces, enabling network segmentation for enhanced security and traffic management. Each VLAN can be configured with its own IP address, DHCP server, and other network settings, effectively creating an independent logical network on a shared physical interface.

The VLAN configuration page, accessible via *Configuration* → *VLAN*, is divided into sections for interface setup, DHCP services, and IPv6 prefix delegation.

1st VLAN Configuration

Create 1st VLAN connection

	IPv4	IPv6
DHCP Client	<input type="text" value="disabled"/>	<input type="text" value="disabled"/>
IP Address	<input type="text"/>	<input type="text"/>
Subnet Mask / Prefix	<input type="text"/>	<input type="text"/>

---

Interface	<input type="text" value="ETH0"/>	
VLAN ID	<input type="text"/>	1-4095
MTU *	<input type="text"/> bytes	576-1500 bytes

---

Enable dynamic DHCP leases

	IPv4	IPv6
IP Pool Start	<input type="text"/>	<input type="text"/>
IP Pool End	<input type="text"/>	<input type="text"/>
Lease Time	<input type="text" value="600"/>	<input type="text" value="600"/> sec

---

Enable static DHCP leases

	MAC Address	IP Address	IPv6 Address
1	<input type="text"/>	<input type="text"/>	<input type="text"/>
2	<input type="text"/>	<input type="text"/>	<input type="text"/>

Maximum 32 items

---

Enable IPv6 prefix delegation

Subnet ID *	<input type="text"/>	
Subnet ID Width *	<input type="text"/> bits	8-32 bits

---

\* can be blank

Figure 24: VLAN configuration page

Item	Description
<i>Create VLAN connection</i>	Enables the creation and configuration of this VLAN interface.
<i>DHCP Client (IPv4/IPv6)</i>	Enables or disables the DHCP client for the VLAN interface. When enabled, the interface will request an IP address from a DHCP server on the network.
<i>IP Address</i>	Assigns a static IPv4 or IPv6 address to the VLAN interface.
<i>Subnet Mask / Prefix</i>	Defines the subnet mask (for IPv4) or prefix length (for IPv6) for the static IP address.
<i>Interface</i>	Selects the parent physical Ethernet interface ( <i>ETH0</i> or <i>ETH1</i> ) to which this VLAN will be bound.

Table 27: VLAN configuration options

Item	Description
<i>VLAN ID</i>	Specifies the unique identifier (1-4094) for the VLAN. This ID is used to tag traffic belonging to this virtual network.
<i>MTU</i>	Sets the Maximum Transmission Unit (MTU) in bytes for this VLAN interface. If left blank, the default value of the parent interface is used.
<i>Enable dynamic DHCP leases</i>	<p>Enables the built-in DHCP server for this VLAN, which can dynamically assign IPv4 and IPv6 addresses to clients.</p> <ul style="list-style-type: none"> <li>• <b>IP Pool Start:</b> The first IP address in the DHCP assignment pool.</li> <li>• <b>IP Pool End:</b> The last IP address in the DHCP assignment pool.</li> <li>• <b>Lease Time:</b> The duration in seconds for which an IP address is leased to a client (default is 600).</li> </ul>
<i>Enable static DHCP leases</i>	<p>Enables static IP address assignments based on a client's MAC address. Up to 32 static leases can be defined for each address family (IPv4 and IPv6).</p> <ul style="list-style-type: none"> <li>• <b>MAC Address:</b> The hardware address of the client device.</li> <li>• <b>IP Address:</b> The fixed IPv4 address to be assigned to the client.</li> <li>• <b>IPv6 Address:</b> The fixed IPv6 address to be assigned to the client.</li> </ul>
<i>Enable IPv6 prefix delegation</i>	<p>Configures the router to request a block of IPv6 addresses from an upstream router, which can then be used to assign addresses to clients on this VLAN.</p> <ul style="list-style-type: none"> <li>• <b>Subnet ID:</b> The identifier for the requested subnet.</li> <li>• <b>Subnet ID Width:</b> The size of the subnet ID in bits.</li> </ul>

Table 27: VLAN configuration page (continued)



VRRP via IPv6 (VRRPv3) is not supported.

### 3.3 VRRP

The Virtual Router Redundancy Protocol (VRRP) is a standard network protocol that provides automatic default gateway redundancy. It creates a virtual router, represented by a shared floating IP address, which is managed by a primary (Master) router and one or more Backup routers. If the Master router fails, a Backup router automatically takes over its role, ensuring that devices on the LAN maintain network connectivity without manual intervention. This is particularly useful for adding cellular redundancy to a primary wired connection or for creating a high-availability setup between two cellular links.

The router supports up to two VRRP instances, which can be configured on the *Configuration* → *VRRP* page.

1st VRRP Instance Configuration			
<input type="checkbox"/> Enable 1st VRRP Instance			
Protocol Version	<input type="text" value="VRRPv2"/>		
Interface	<input type="text" value="ETH0"/>		
Virtual Server IP Address	<input type="text"/>		
Virtual Server ID	<input type="text"/>		1-255
Host Priority	<input type="text"/>		1-254
<input type="checkbox"/> Check connection			
Ping IP Address	<input type="text"/>		
Ping Interval	<input type="text"/>	sec	1-4294 sec
Ping Timeout	<input type="text"/>	sec	1-60 sec
Ping Probes	<input type="text"/>		1-10
<input type="checkbox"/> Enable traffic monitoring			
<input type="button" value="Apply"/>			

Figure 25: VRRP configuration page

#### VRRP Instance Configuration

To enable and configure a VRRP instance, check the *Enable VRRP* box and configure the following parameters:

Item	Description
<i>Protocol Version</i>	Specifies the VRRP version to be used. <ul style="list-style-type: none"> <li>• <b>VRRPv2</b>: The original standard, widely supported, for IPv4 networks.</li> <li>• <b>VRRPv3</b>: The newer standard that adds support for IPv6 networks.</li> </ul>
<i>Interface</i>	Selects the network interface (e.g., <i>ETH0</i> ) on which VRRP advertisements will be sent and received.
<i>Virtual Server IP Address</i>	Sets the shared virtual IP address. This address must be identical for all routers in the VRRP group and serves as the default gateway for all LAN devices.
<i>Virtual Server ID</i>	Defines the identifier for the virtual router group. The range is 1–255. This ID must be identical for all routers participating in the same VRRP group.
<i>Host Priority</i>	Sets the priority value used to elect the Master router. The range is 1–254 (default is 100). <ul style="list-style-type: none"> <li>• The router with the highest priority value becomes the Master.</li> <li>• If the Virtual Server IP matches the interface's real IP, the priority is automatically set to 255 (IP Address Owner), overriding this setting.</li> </ul>

Table 28: VRRP instance configuration options

## Connection Checking

The *Check connection* feature adds a crucial layer of reliability by actively testing the health of the router's WAN connection. While VRRP itself detects router failures, this feature can detect upstream network outages even if the router is still running.

When enabled, the Master router periodically sends ICMP echo requests (pings) to a specified target IP address. If no replies are received after a configurable number of attempts, the router assumes the connection has failed and lowers its VRRP priority, triggering a failover to a Backup router.

### Info

For reliable connection monitoring, ping a stable public IP address (e.g., a public DNS server like 8.8.8.8). In a private network, you can ping a remote gateway that is directly accessible or available via a VPN.

The *Enable traffic monitoring* option optimizes this process by suspending ping tests as long as any other traffic is received on the interface. This confirms the connection is active and reduces unnecessary data usage.

Item	Description
<i>Ping IP Address</i>	The destination IP address for the ICMP echo requests. Domain names are not supported.
<i>Ping Interval</i>	The time in seconds between each ping request.
<i>Ping Timeout</i>	The time in seconds to wait for a response to each ping.
<i>Ping Probes</i>	The number of consecutive failed pings before the connection is declared down.

Table 29: Connection checking parameters

## Configuration Example

This example illustrates a high-availability topology using two routers, each with an independent cellular connection. For maximum redundancy, APN 1 and APN 2 are provided by different mobile operators.

- **LAN Side:** Both routers share the Virtual IP address **192.168.1.1** (Virtual Server ID 5). LAN clients use this IP as their default gateway, unaware of the physical routers.
- **Priorities:** The Main router (Real IP **192.168.1.2**) is configured with a higher priority of **200**, making it the Master. The Backup router (Real IP **192.168.1.3**) has a lower priority of **100**.
- **WAN Side:** To ensure end-to-end connectivity, both routers monitor a reliable public target (**8.8.8.8**) via their respective cellular WAN interfaces.

If the Main router fails to receive a ping response from 8.8.8.8, it automatically lowers its priority. The Backup router then becomes the new Master and takes over the Virtual IP, ensuring uninterrupted Internet access for all LAN clients.

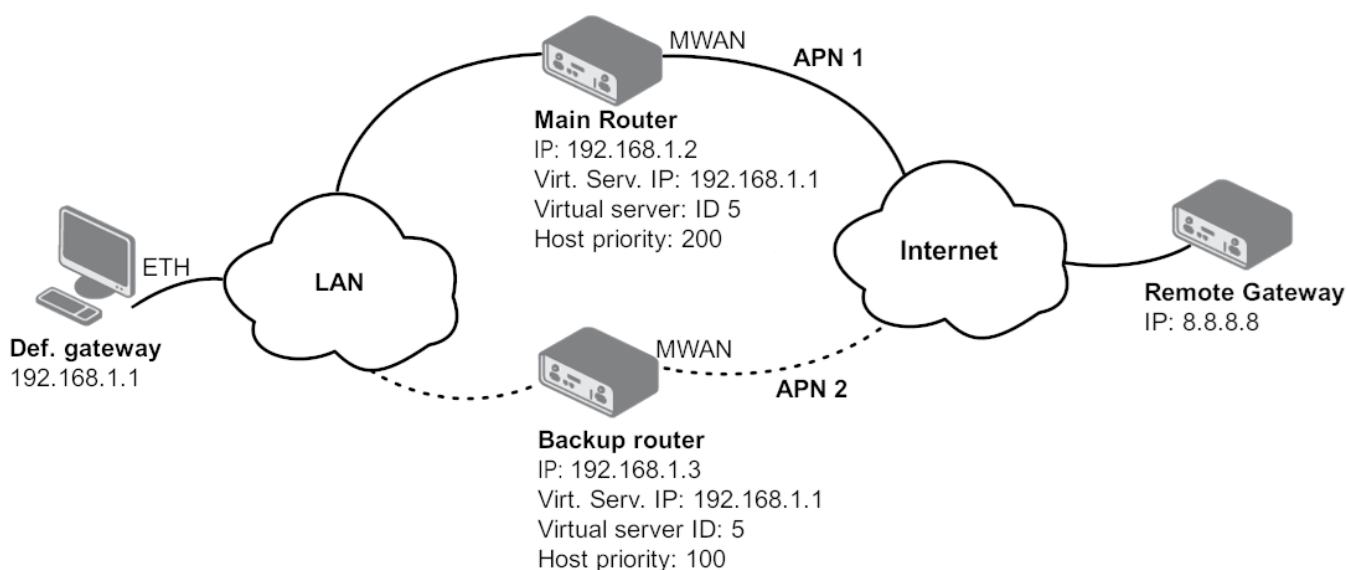

Figure 26: An example of VRRP topology

1st VRRP Instance Configuration			
<input checked="" type="checkbox"/>	Enable 1st VRRP Instance		
Protocol Version	VRRPv2		
Interface	ETH0		
Virtual Server IP Address	192.168.1.1		
Virtual Server ID	5		1-255
Host Priority	200		1-254
<input checked="" type="checkbox"/>	Check connection		
Ping IP Address	8.8.8.8		
Ping Interval	10	sec	1-4294 sec
Ping Timeout	5	sec	1-60 sec
Ping Probes	10		1-10
<input type="checkbox"/>	Enable traffic monitoring		

Figure 27: Main router configuration

Configure the backup router identically to the main router (see Figure 27), with one exception: set the **Host Priority** to **100**. The *Check connection* settings should remain the same.

### 3.4 Mobile WAN

Select the *Mobile WAN* item in the *Configuration* menu section to enter the cellular network configuration page. See *Mobile WAN Configuration* page in Figure 29.

1st Mobile WAN Configuration					
<input type="checkbox"/> Create connection to mobile network					
	1st SIM card	2nd SIM card			
Carrier	Outside North America ▼	Outside North America ▼			
APN *	<input type="text"/>	<input type="text"/>			
Username *	<input type="text"/>	<input type="text"/>			
Password *	<input type="password"/>	<input type="password"/>			
Authentication	PAP or CHAP ▼	PAP or CHAP ▼			
IP Mode	IPv4 ▼	IPv4 ▼			
IP Address *	<input type="text"/>	<input type="text"/>			
Dial Number *	<input type="text"/>	<input type="text"/>			
Operator *	<input type="text"/>	<input type="text"/>	comma-separated list		
Network Type	automatic selection ▼	automatic selection ▼			
PIN *	<input type="text"/>	<input type="text"/>			
MRU	1500	1500	bytes	1280-16384 bytes	
MTU	1500	1500	bytes	1280-16384 bytes	
DNS Settings	get from operator ▼	get from operator ▼			
Primary DNS Server	<input type="text"/>	<input type="text"/>			
Primary IPv6 DNS Server	<input type="text"/>	<input type="text"/>			
Secondary DNS Server	<input type="text"/>	<input type="text"/>			
Secondary IPv6 DNS Server	<input type="text"/>	<input type="text"/>			
<i>(The feature of check connection to mobile network is necessary for uninterrupted operation)</i>					
Check Connection	disabled ▼	disabled ▼			
Ping IP Address	<input type="text"/>	<input type="text"/>	upto two comma-separated values		
Ping IPv6 Address	<input type="text"/>	<input type="text"/>	upto two comma-separated values		
Ping Interval	<input type="text"/>	<input type="text"/>	sec	1-86400 sec	
Ping Timeout	10	10	sec	1-86400 sec	

Figure 28: Mobile WAN configuration page – part 1

<input type="checkbox"/> Enable traffic monitoring			
Data Limit	<input type="text"/>	<input type="text"/>	MiB 1-2097152 MiB
Warning Threshold	<input type="text"/>	<input type="text"/>	% 50-99%
Accounting Start	<input type="text" value="1"/>	<input type="text" value="1"/>	1-28
SIM Card	<input type="text" value="enabled"/>	<input type="text" value="enabled"/>	
Registration Timeout *	<input type="text"/>	<input type="text"/>	sec
Roaming State	<input type="text" value="not applicable"/>	<input type="text" value="not applicable"/>	
Data Limit State	<input type="text" value="not applicable"/>	<input type="text" value="not applicable"/>	
Digital Input 0 State	<input type="text" value="not applicable"/>	<input type="text" value="not applicable"/>	
Default SIM Card	<input type="text" value="1st"/>		
Initial State	<input type="text" value="online"/>		
<input type="checkbox"/> Switch to other SIM card when connection fails			
<input type="checkbox"/> Switch to default SIM card after timeout			
Initial Timeout	<input type="text" value="60"/>	min	1-10000 min
Subsequent Timeout *	<input type="text"/>	min	0-10000 min
Additive Constant *	<input type="text"/>	min	0-1000 min
<input type="checkbox"/> Enable PPPoE bridge mode			
<input type="checkbox"/> Enable debugging			
* can be blank			
<input type="button" value="Apply"/>			

Figure 29: Mobile WAN configuration page – part 2

## Connection to Mobile Network

### Info

- Starting with firmware version 6.6.0, PLMN whitelisting is now an integrated firmware feature, available in the *Operator* field. This native functionality replaces the legacy *PLMN Whitelist* Router App.
- To avoid potential conflicts, you must disable or uninstall the legacy Router App before using the integrated PLMN whitelisting feature.

If the *Create connection to mobile network* checkbox is checked, the router will automatically attempt to establish a connection after booting up. You can specify the following parameters for each SIM card separately.

Item	Description
<i>Carrier</i>	<p>This option allows for the manual or automatic selection of a mobile network carrier. <b>It is primarily available and fully configurable for global or NAM (North American) certified router models.</b></p> <ul style="list-style-type: none"> <li>For router models <b>not certified for NAM</b>, or for <b>global models</b>, an <i>Outside North America</i> option is available, which sets a profile that restricts connections to non-NAM operators.</li> <li>For router models <b>certified for NAM</b>, several choices are typically offered: <ul style="list-style-type: none"> <li><i>North America, Autoselect</i>: Allows the router to automatically detect and connect to a suitable NAM operator.</li> <li><i>North America, Generic</i>: Enables a generic North American PTCRB (PCS Type Certification Review Board) compliant configuration, if supported by the router model.</li> <li>Manual selection of specific NAM operators: A list of certified operators is provided, which may include <i>AT&amp;T, Rogers, T-Mobile, or Verizon</i>.</li> </ul> </li> </ul>
<i>APN</i>	Network identifier (Access Point Name).
<i>Username</i>	The user name used for logging on to the GSM network.
<i>Password</i>	The password used for logging on to the GSM network. Enter valid characters only, see chap. 1.2.1.
<i>Authentication</i>	<p>Authentication protocol used in the GSM network:</p> <ul style="list-style-type: none"> <li><b>PAP or CHAP</b> – The router selects the authentication method.</li> <li><b>PAP</b> – The router uses the PAP authentication method.</li> <li><b>CHAP</b> – The router uses the CHAP authentication method.</li> </ul>
<i>IP Mode</i>	<p>Specifies the version of IP protocol used:</p> <ul style="list-style-type: none"> <li><b>IPv4</b> – IPv4 protocol is used only (default).</li> <li><b>IPv6</b> – IPv6 protocol is used only.</li> <li><b>IPv4/IPv6</b> – IPv4 and IPv6 independent dual stack is enabled.</li> </ul>
<i>IP Address</i>	For use in IPv4 and IPv4/IPv6 mode only. Specifies the IPv4 address of the SIM card. You manually enter the IP address only when mobile network carrier has assigned the IP address.
<i>Dial Number</i>	Specifies the telephone number which the router dials for a GPRS or CSD connection. The router uses the default telephone number *99***1 #.
<i>Operator</i>	Specifies the carrier code. You can specify this parameter as the PLNM preferred carrier code.
<i>Network type</i>	<p>Specifies the type of protocol used in the mobile network.</p> <ul style="list-style-type: none"> <li><b>Automatic selection</b> – The router automatically selects a transmission method according to the availability of transmission technologies.</li> <li>It is also possible to select one of the following specific methods of data transmission: <b>LTE, UMTS/HSPA, GPRS/EDGE</b>.</li> </ul>

Table 30: Mobile WAN configuration items description

Item	Description
<i>PIN</i>	Specifies the PIN used to unlock the SIM card. Use only if this is required by a given SIM card. The SIM card will be blocked after several failed attempts to enter the PIN.
<i>MRU</i>	Maximum Receive Unit – maximum size of packet that the router can receive via Mobile WAN. The default value is 1500 B. Other settings may cause the router to receive data incorrectly. Minimal value in IPv4 and IPv4/IPv6 mode: 128 B. Minimal value in IPv6 mode: 1280 B.
<i>MTU</i>	Maximum Transmission Unit – maximum size of packet that the router can transmit via Mobile WAN. The default value is 1500 B. Other settings may cause the router to transmit data incorrectly. Minimal value in IPv4 and IPv4/IPv6 mode: 128 B. Minimal value in IPv6 mode: 1280 B.

Table 30: Mobile WAN configuration items description (continued)

**Info**

The following is a list of tips for working with the *1st/2nd Mobile WAN Configuration* form:

- If the MTU size is set incorrectly, then the router will not exceed the data transfer. If the MTU value is set too low, more frequent fragmentation of data will occur. More frequent fragmentation will mean a higher overhead and also the possibility of packet damage during defragmentation. In contrast, a higher MTU value can cause the network to drop the packet.
- If the *IP address* field is left blank, when the router establishes a connection, the mobile network carrier will automatically assign an IP address. If you assign an IP address manually, then the router will access the network quicker.
- If the **APN** field is left blank, the router automatically selects the APN using the IMSI code of the SIM card. The name of the chosen APN can be found in the System Log.
- If you enter the word *blank* in the *APN* field, then the router interprets the APN as blank.

**Warning**

The correct PIN must be filled in. An incorrect PIN may block the SIM card.

Parameters identified with an asterisk require you to enter the appropriate information only if this information is required by the mobile network carrier.

When the router is unsuccessful in establishing a connection to mobile network, you should verify accuracy of the entered data. Alternatively, you could try a different authentication method or network type.

### DNS Configuration

The *DNS Settings* parameter is designed for easier configuration on the client’s side. When this value is set to *get from operator* the router will attempt to automatically obtain an IP address from the primary and secondary DNS server of the mobile network carrier. To specify the IP addresses of the Primary DNS servers manually, on the *DNS Server* pull down list select the value *set manually*. You can also fill-in the IPv4 or IPv6 address of the DNS server (or both) based on the IP Mode option.

### Mobile Network Connection Check



Enabling the *Check Connection* function for mobile networks is necessary for uninterrupted and continuous operation of the router.

If the *Check Connection* item is set to *enabled* or *enabled + bind*, the router will be sending the ping requests to the specified domain or IP address configured in *Ping IP Address* or *Ping IPv6 Address* at regular time intervals set up in the *Ping Interval*.

In case of an unsuccessful ping, a new ping will be sent after the *Ping Timeout*. If the ping is unsuccessful three times in a row, the router will terminate the cellular connection and will attempt to establish a new one.

This monitoring function can be set for both SIM cards separately, but running on the active SIM at given time only. Be sure, you configure a functional address as the destination for the ping, for example an IP address of the operator’s DNS server.

If the *Check Connection* item is set to the *enabled*, the ping requests are being sent on the basis of the routing table. Therefore, the requests may be sent through any available interface. If you require each ping request to be sent through the network interface, which was created when establishing a connection to the mobile operator, it is necessary to set the *Check Connection* to *enabled + bind*. The *disabled* option deactivates checking of the connection to the mobile network.



A note for routers connected to the **Verizon** carrier (detected by the router):  
The retry interval for connecting to the mobile network prolongs with more retries. First two retries are done after 1 minute. Then the interval prolongs to 2, 8 and 15 minutes. The ninth and every other retry is done in 90 minutes interval.

If *Enable Traffic Monitoring* item is checked, the router will monitor the Mobile WAN traffic without sending the ping requests. If there is no traffic, the router will start sending the ping requests.

Item	Description
<i>Ping IP Address</i>	The destination IPv4 address or domain name for ping queries. You can specify up to two comma-separated values. If two addresses are provided, the connection is considered failed only when neither address responds. Available in <i>IPv4</i> and <i>IPv4/IPv6 IP Mode</i> .
<i>Ping IPv6 Address</i>	The destination IPv6 address or domain name for ping queries. You can specify up to two comma-separated values. If two addresses are provided, the connection is considered failed only when neither address responds. Available in <i>IPv6</i> and <i>IPv4/IPv6 IP Mode</i> .
<i>Ping Interval</i>	The time interval between outgoing pings.
<i>Ping Timeout</i>	The time (in seconds) to wait for a ping response.

Table 31: Check connection to mobile network configuration

### Connection Check Example

The figure below displays the following scenario: the connection to the mobile network in IPv4 *IP Mode* is controlled on the address 8.8.8.8 with a time interval of 60 seconds for the first SIM card and on the address www.google.com with the time interval 80 seconds for the second SIM card (for an active SIM only). Because the *Enable traffic monitoring* option is enabled, the control pings are not sent, but the data stream is monitored. The ping will be sent, if the data stream is interrupted.

*(The feature of check connection to mobile network is necessary for uninterrupted operation)*

Check Connection	<input type="text" value="enabled"/>	<input type="text" value="enabled"/>	
Ping IP Address	<input type="text" value="8.8.8.8"/>	<input type="text" value="www.google.com"/>	upto two comma-separated values
Ping IPv6 Address	<input type="text"/>	<input type="text"/>	upto two comma-separated values
Ping Interval	<input type="text" value="60"/>	<input type="text" value="80"/>	sec 1-86400 sec
Ping Timeout	<input type="text" value="60"/>	<input type="text" value="80"/>	sec 1-86400 sec

Enable traffic monitoring

Figure 30: Connection check example

### Data Limit Settings



**Info**

The *Data Limit* parameters serve two independent functions:

- **SMS Warning:** Triggered based on the *Warning Threshold*. This requires the *Send SMS when data limit is exceeded* option to be enabled in the *Services → SMS* configuration page.
- **SIM Switching:** To force the router to switch to another SIM once the *Data Limit* is reached, the *Data Limit State* parameter in the lower part of the form must be set to *not exceeded*. If left as *not applicable*, the limit is ignored for switching purposes.

Item	Description
<i>Data Limit</i>	The maximum amount of data (sent and received) allowed per billing period (one month). The maximum configurable value is 2 TB (2,097,152 MB). See the info box above for important details on how this limit is applied.
<i>Warning Threshold</i>	A percentage of the <i>Data Limit</i> (ranging from 50% to 99%). When this threshold is exceeded, the router sends an SMS message. See the info box above for prerequisites.
<i>Accounting Start</i>	The day of the month when the billing cycle begins. The router starts counting data from this day.

Table 32: Data limit configuration

## SIM Card Switching

In the lower part of the configuration form you can specify the rules for toggling between the two SIM cards.

The router will automatically toggle between the SIM cards and their individual setups depending on the configuration settings specified here (manual permission, roaming, data limit, binary input state). Note that the SIM card selected for connection establishment is the result of the logical product (AND) of the configuration here (table below).



Item	Description
<i>SIM Card</i>	<p>Enable or disable the use of a SIM card. If you set all the SIM cards to <i>disabled</i>, this means that the entire cellular module is disabled.</p> <ul style="list-style-type: none"> <li>• <b>enabled</b> – It is possible to use the SIM card.</li> <li>• <b>disabled</b> – Never use the SIM card, the usage of this SIM is forbidden.</li> </ul>
<i>Registration Timeout</i>	<p>Sets the registration timeout for the SIM card in seconds. The default value is 2 minutes. If not set, the default timeout will be used.</p>
<i>Roaming State</i>	<p>Configure the use of SIM cards based on roaming. This roaming feature has to be activated for the SIM card on which it is enabled!</p> <ul style="list-style-type: none"> <li>• <b>not applicable</b> – It is possible to use the SIM card everywhere.</li> <li>• <b>home network only</b> – Only use the SIM card if roaming is not detected.</li> </ul>
<i>Data Limit State</i>	<p>Configure the use of SIM cards based on the Data Limit set above:</p> <ul style="list-style-type: none"> <li>• <b>not applicable</b> – It is possible to use the SIM regardless of the limit.</li> <li>• <b>not exceeded</b> – Use the SIM card only if the Data Limit (set above) has not been exceeded.</li> </ul>
<i>BINO State</i>	<p>Configure the use of SIM cards based on binary input 0 state:</p> <ul style="list-style-type: none"> <li>• <b>not applicable</b> – It is possible to use the SIM regardless of BINO state.</li> <li>• <b>on</b> – Only use the SIM card if the BINO state is logical 0 – voltage present.</li> <li>• <b>off</b> – Only use the SIM card if the BINO state is logical 1 – no voltage.</li> </ul>

Table 33: SIM card switching configuration

Use the following parameters to specify the decision making of SIM card switching in the cellular module.

Item	Description
<i>Default SIM Card</i>	<p>Specifies the modules' default SIM card. The router will attempt to establish a connection to mobile network using this default.</p> <ul style="list-style-type: none"> <li>• <b>1st</b> – The 1st SIM card is the default one.</li> <li>• <b>2nd</b> – The 2nd SIM card is the default one.</li> </ul>
<i>Initial State</i>	<p>Specifies the action of the cellular module after the SIM card has been selected.</p> <ul style="list-style-type: none"> <li>• <b>online</b> – establish connection to the mobile network after the SIM card has been selected (default).</li> <li>• <b>offline</b> – go to the off-line mode after the SIM card has been selected.</li> </ul> <p>Note: If offline, you can change this initial state by SMS message only – see <i>SMS Configuration</i>. The cellular module will also go into off-line mode if none of the SIM cards are not selected.</p>
<i>Switch to other SIM card when connection fails</i>	<p>Applicable only when connection is established on the default SIM card and then fails. If the connection failure is detected by <i>Check Connection</i> feature above, the router will switch to the backup SIM card.</p>
<i>Switch to default SIM card after timeout</i>	<p>If enabled, after timeout, the router will attempt to switch back to the default SIM card. This applies only when there is default SIM card defined and the backup SIM is selected because of a <b>failure</b> of the default one or if <b>roaming</b> settings cause the switch. This feature is available only when <i>Switch to other SIM card when connection fails</i> is enabled.</p>
<i>Initial Timeout</i>	<p>Specifies the length of time that the router waits before the first attempt to revert to the default SIM card, the range of this parameter is from 1 to 10000 minutes.</p>
<i>Subsequent Timeout</i>	<p>Specifies the length of time that the router waits after an unsuccessful attempt to revert to the default SIM card, the range is from 1 to 10000 min.</p>
<i>Additive Constant</i>	<p>Specifies the length of time that the router waits for any further attempts to revert to the default SIM card. This length time is the sum of the time specified in the "Subsequent Timeout" parameter and the time specified in this parameter. The range in this parameter is from 1 to 10000 minutes.</p>

Table 34: Parameters for SIM card switching

## Other Settings

This chapter describes the remaining configuration items within the Mobile WAN settings.

Item	Description
<i>Enable PPPoE bridge mode</i>	Enables the PPPoE (Point-to-Point Protocol over Ethernet) bridge mode on the <i>Mobile WAN</i> interface. When enabled, the router acts as a transparent bridge for PPPoE traffic, forwarding PPPoE frames between the cellular WAN interface and a designated device on the LAN. This allows a device (e.g., a PC or another router) connected to the router's LAN to establish a direct PPPoE connection with the mobile network operator, thereby obtaining the IP address assigned by the operator directly onto that end device. This function is distinct from standard Layer 2 Ethernet or Wi-Fi bridging and specifically applies to PPPoE traffic over the Mobile WAN interface.
<i>Enable debugging</i>	Enables detailed diagnostic logging features for troubleshooting purposes. When active, extensive debugging information is recorded. For these debug-level messages to be captured and visible in the system log, you must also set the <i>Minimum Severity</i> to <i>Debug</i> in the <i>Configuration</i> → <i>Services</i> → <i>Syslog</i> section of the web interface. <b>Note:</b> Debug logging can generate a large volume of data. It is strongly recommended to disable this option once troubleshooting is complete.

Table 35: Other settings

### SIM Card Switching Configuration Examples

#### Example 1: Timeout Configuration

Mark the *Switch to default SIM card after timeout* check box, and fill-in the following values:

<input checked="" type="checkbox"/>	Switch to other SIM card when connection fails		
<input checked="" type="checkbox"/>	Switch to default SIM card after timeout		
Initial Timeout	<input type="text" value="60"/>	min	1-10000 min
Subsequent Timeout *	<input type="text" value="30"/>	min	0-10000 min
Additive Constant *	<input type="text" value="20"/>	min	0-1000 min

Figure 31: Configuration for SIM card switching example 1

The first attempt to change to the default SIM card is carried out after 60 minutes. When the first attempt fails, a second attempt is made after 30 minutes. A third attempt is made after 50 minutes (30+20). A fourth attempt is made after 70 minutes (30+20+20).

#### Example 2: Data Limit Switching

This example demonstrates how to configure the router to automatically switch to the second SIM card once the data limit of 800 MB is exceeded on the first (default) SIM.

Crucially, the *Data Limit State* for the 1st SIM card must be set to *not exceeded*. An SMS warning is also sent upon reaching 400 MB (50% threshold), which requires enabling the corresponding feature on the *SMS Configuration* page. The billing period starts on the 18th day of the month.

Data Limit	<input type="text" value="800"/>	<input type="text"/>	MiB	1-2097152 MiB
Warning Threshold	<input type="text" value="50"/>	<input type="text"/>	%	50-99%
Accounting Start	<input type="text" value="18"/>	<input type="text" value="1"/>		1-28
SIM Card	<input type="text" value="enabled"/>	<input type="text" value="enabled"/>		
Registration Timeout *	<input type="text"/>	<input type="text"/>	sec	
Roaming State	<input type="text" value="not applicable"/>	<input type="text" value="not applicable"/>		
Data Limit State	<input type="text" value="not exceeded"/>	<input type="text" value="not applicable"/>		
Digital Input 0 State	<input type="text" value="not applicable"/>	<input type="text" value="not applicable"/>		
Default SIM Card	<input type="text" value="1st"/>			
Initial State	<input type="text" value="online"/>			
<input type="checkbox"/>	Switch to other SIM card when connection fails			
<input type="checkbox"/>	Switch to default SIM card after timeout			
Initial Timeout	<input type="text"/>	min		1-10000 min
Subsequent Timeout *	<input type="text"/>	min		0-10000 min
Additive Constant *	<input type="text"/>	min		0-1000 min

Figure 32: Configuration for SIM card switching example 2

### 3.5 PPPoE

Point-to-Point Protocol over Ethernet (PPPoE) is a network protocol used to encapsulate PPP frames within Ethernet frames. It is commonly used to establish a connection with a broadband modem (e.g., ADSL) or other network device that acts as a PPPoE server. The router's PPPoE client allows it to authenticate and establish a session, after which it receives a public IP address and can forward traffic to the Internet.

The PPPoE settings are available on the *Configuration* → *PPPoE* page.

PPPoE Configuration

Create PPPoE connection

Interface ETH0 ▼

---

Username \*

Password \*  👁

Authentication PAP or CHAP ▼

IP Mode IPv4 ▼

MRU  bytes 128-16384 bytes

MTU  bytes 128-16384 bytes

Clamp Max. Segment Size

---

DNS Settings get from server ▼

Primary DNS Server

Primary IPv6 DNS Server

Secondary DNS Server

Secondary IPv6 DNS Server

---

\* can be blank

Figure 33: PPPoE configuration page

Item	Description
<i>Create PPPoE connection</i>	Enables the PPPoE client on the selected interface. When checked, the router will automatically attempt to establish a connection on boot.
<i>Interface</i>	Selects the Ethernet interface ( <i>ETH0</i> or <i>ETH1</i> ) on which the PPPoE client will operate.
<i>Username</i>	The username required for authentication with the PPPoE server.
<i>Password</i>	The password for the specified username.
<i>Authentication</i>	Specifies the authentication protocol to be used. <ul style="list-style-type: none"> <li>• <b>PAP or CHAP:</b> Allows the router to negotiate and use either protocol (default).</li> <li>• <b>PAP:</b> Forces the use of Password Authentication Protocol.</li> <li>• <b>CHAP:</b> Forces the use of Challenge-Handshake Authentication Protocol.</li> </ul>
<i>IP Mode</i>	Defines the IP protocol version for the connection. <ul style="list-style-type: none"> <li>• <b>IPv4:</b> Establishes an IPv4-only session (default).</li> <li>• <b>IPv6:</b> Establishes an IPv6-only session.</li> <li>• <b>IPv4/IPv6:</b> Enables a dual-stack session for both IPv4 and IPv6.</li> </ul>

Table 36: PPPoE configuration options

Item	Description
<i>MRU</i>	Defines the Maximum Receive Unit in bytes, which is the largest packet size the router can receive. The default is 1492 bytes.
<i>MTU</i>	Defines the Maximum Transmission Unit in bytes, which is the largest packet size the router can transmit. The default is 1492 bytes.
<i>Clamp Max. Segment Size</i>	When enabled (default), this option automatically adjusts the TCP Maximum Segment Size (MSS) to prevent fragmentation, which can improve performance and reliability.
<i>DNS Settings</i>	Configures how DNS servers are obtained. <ul style="list-style-type: none"><li>• <b>Get from server:</b> Automatically uses the DNS servers provided by the PPPoE server (default).</li><li>• <b>Manual:</b> Allows you to specify primary and secondary DNS servers manually.</li></ul>

Table 36: PPPoE configuration options (continued)

**Warning**

Setting an incorrect MTU or MRU value can lead to packet fragmentation or loss, resulting in a failed or unreliable connection. It is recommended to use the default value of 1492 bytes unless your provider requires a different setting.

## 3.6 WiFi

### 3.6.1 Access Point

#### Warning

##### Important Note on Upgrading to Firmware 6.6.0

When upgrading from a firmware version prior to 6.6.0, any separate *Country* settings for the Wi-Fi Access Point (AP) and Station (STA) modes will be consolidated into a single, unified *Country* setting. This change ensures regulatory compliance and simplifies configuration. For more details, please refer to Chapter 3.6.3 *Country*.

#### Info

- The router supports configuring two separate WLANs (**multiple SSIDs**) for access point 1 (AP1) and access point 2 (AP2). However, both access points must share the same radio settings (channel, mode, channel width, etc.).
- The router does not support operating as an access point (AP) and a station (STA) at the same time.
- **RADIUS** (Remote Authentication Dial-In User Service) is supported as a networking protocol for centralized authentication, authorization, and accounting (AAA). The router acts only as a RADIUS client, communicating with an external RADIUS server.

To enable Wi-Fi access point mode, check the *Enable Wi-Fi AP* box at the top of the *Configuration* → *WiFi* → *Access Point 1* or *Access Point 2* configuration page. In this mode, the router operates as an access point, allowing other devices in *station (STA)* mode to connect.

The tables below list the available configuration options.

Item	Description
<i>Enable WiFi AP</i>	Enables the Wi-Fi access point (AP). Both Access Point 1 (AP1) and Access Point 2 (AP2) can be enabled and operated simultaneously.
<i>Country</i>	A single Wi-Fi Country code applies to all AP and STA interfaces and is configured on a separate page (accessible via the <i>Change</i> button). After changing the country, you must review the <i>HW Mode</i> , <i>Bandwidth</i> , and <i>Channel</i> settings.
<i>IP Address</i>	A fixed IP address for the Wi-Fi interface. Use standard IPv4 or IPv6 notation.
<i>Subnet Mask / Prefix</i>	Specifies the Subnet Mask for an IPv4 address or the prefix length (0 to 128) for an IPv6 address.
<i>Bridged</i>	Activates bridge mode: <ul style="list-style-type: none"> <li>• <b>no</b> – Bridged mode is disabled (default). The WLAN is a separate network from the LAN.</li> <li>• <b>yes</b> – Bridged mode is enabled. The WLAN is connected to one or more LAN networks. In this mode, most network settings in this table are ignored, and the router uses the settings of the bridged LAN interface.</li> </ul> See the <b>Bridge Notes</b> in Chapter 3.1 <i>Ethernet</i> for further details.
<i>Enable dynamic DHCP leases</i>	Enables the dynamic allocation of IP addresses using the DHCP (or DHCPv6) server.
<i>IP Pool Start</i>	The start of the IP address range assigned to DHCP clients.
<i>IP Pool End</i>	The end of the IP address range assigned to DHCP clients.
<i>Lease Time</i>	The duration (in seconds) for which a client can use its assigned IP address.

Table 37: Wi-Fi configuration items description

Item	Description
<i>Enable IPv6 prefix delegation</i>	Enables prefix delegation for IPv6 clients.
<i>Subnet ID</i>	The decimal value of the Subnet ID for the interface. The maximum value is determined by the <i>Subnet ID Width</i> .
<i>Subnet ID Width</i>	The maximum Subnet ID width, which depends on your site's configuration. The remaining bits (up to 64) are used for the prefix.
<i>SSID</i>	The unique identifier (name) of the Wi-Fi network. Access Point 1 (AP1) and Access Point 2 (AP2) can have different SSIDs.
<i>Broadcast SSID</i>	Defines how the SSID is broadcast in the beacon frame: <ul style="list-style-type: none"> <li>• <b>enabled</b> – The SSID is included in the beacon frame (standard behavior).</li> <li>• <b>zero length</b> – The SSID is omitted from the beacon frame. Requests to send beacon frames are ignored.</li> <li>• <b>clear</b> – SSID characters in the beacon are replaced with zeros, but the original length is maintained. Requests for beacon frames are ignored.</li> </ul>
<i>SSID Isolation</i>	When enabled with a selected zone, clients on this access point cannot communicate with clients on other access points that have a different zone selected.
<i>Client Isolation</i>	If enabled, clients connected to this access point are prevented from communicating with each other. If disabled, the AP functions like a switch, allowing clients on the same LAN to communicate.
<i>WMM</i>	Enables basic QoS (Quality of Service) for the Wi-Fi network. This feature is suitable for simple applications that require QoS but does not guarantee network throughput.
<i>Follow STA radio settings</i>	When enabled, if the STA (Station) mode is connected to an external Access Point, the router's own AP radio settings will automatically adjust to match those of the external AP.
<i>HW Mode<sup>1</sup></i>	Specifies the Wi-Fi standard supported by the access point. Options include: <ul style="list-style-type: none"> <li>• IEEE 802.11b (2.4 GHz)</li> <li>• IEEE 802.11b+g (2.4 GHz)</li> <li>• IEEE 802.11b+g+n (2.4 GHz)</li> <li>• IEEE 802.11a (5 GHz)</li> <li>• IEEE 802.11a+n (5 GHz)</li> <li>• IEEE 802.11ac (5 GHz)</li> </ul> This setting is shared by both Access Point 1 and Access Point 2.
<i>Bandwidth<sup>1</sup></i>	Allows you to select the transfer bandwidth. This option may be unavailable for some hardware modes. If the selected bandwidth is occupied, the router may automatically switch to a lower bandwidth. This setting is shared by both Access Point 1 and Access Point 2.
<i>Channel<sup>1</sup></i>	The channel on which the Wi-Fi access point operates. Available channels depend on the selected <i>Country</i> . Select <i>Auto</i> to allow the router to choose the optimal channel automatically. <b>If you change the country, review this setting</b> , as the previously selected channel may no longer be valid. This setting is shared by both Access Point 1 and Access Point 2. <u>Note:</u> When <i>40 MHz</i> bandwidth is selected, the interpretation of the channel number depends on the Wi-Fi band: <ul style="list-style-type: none"> <li>• In the 2.4 GHz band, the channel number refers to the primary (20 MHz) channel.</li> <li>• In the 5 GHz and 6 GHz bands, the channel number refers to the center frequency of the 40 MHz channel.</li> </ul> <u>Note:</u> On NAM routers, only channels 1 to 11 are supported in the 2.4 GHz band.

Table 37: Wi-Fi configuration items description (continued)

Item	Description
<i>Short GI</i>	This option, available for 802.11n mode, enables a short guard interval (400 ns instead of 800 ns) to improve data transmission efficiency. This setting is shared by both Access Point 1 and Access Point 2.
<i>Authentication</i>	Defines the access control method for the Wi-Fi network. <ul style="list-style-type: none"> <li>• <b>open:</b> [insecure] No authentication required. Encryption is not available for this option.</li> <li>• <b>shared:</b> [insecure] Basic authentication with a WEP key.</li> <li>• <b>WPA-PSK:</b> [insecure] Pre-Shared Key authentication with WPA encryption.</li> <li>• <b>WPA2-PSK:</b> [insecure] Pre-Shared Key authentication with WPA2 encryption (AES).</li> <li>• <b>WPA3-PSK:</b> Simultaneous Authentication of Equals (SAE) with WPA3 encryption (AES).</li> <li>• <b>WPA-Enterprise:</b> [insecure] RADIUS-based authentication via an external server.</li> <li>• <b>WPA2-Enterprise:</b> RADIUS-based authentication with stronger encryption.</li> <li>• <b>WPA3-Enterprise:</b> RADIUS-based authentication with stronger encryption.</li> </ul>
<i>Encryption</i>	Specifies the type of data encryption. <ul style="list-style-type: none"> <li>• <b>none:</b> [insecure] No data encryption.</li> <li>• <b>WEP:</b> [insecure] Wired Equivalent Privacy.</li> <li>• <b>TKIP:</b> [insecure] Temporal Key Integrity Protocol, used for WPA.</li> <li>• <b>AES:</b> Advanced Encryption Standard, used for WPA2/WPA3.</li> </ul>
<i>WPA PSK Type</i>	Specifies the format of the WPA Pre-Shared Key: <ul style="list-style-type: none"> <li>• <b>256-bit secret:</b> A 64-character hexadecimal key.</li> <li>• <b>ASCII passphrase:</b> A passphrase of 8 to 63 characters.</li> <li>• <b>PSK File:</b> The absolute path to a file containing key-MAC address pairs.</li> </ul>
<i>WPA PSK Secret</i>	The secret key or passphrase for WPA-PSK authentication.
<i>RADIUS Auth Server IP</i>	The IPv4 or IPv6 address of the RADIUS authentication server.
<i>RADIUS Auth Password</i>	The access password for the RADIUS authentication server.
<i>RADIUS Auth Port</i>	The port number of the RADIUS authentication server (default is 1812).
<i>RADIUS Acct Server IP</i>	The IPv4 or IPv6 address of the RADIUS accounting server (if different from the authentication server).
<i>RADIUS Acct Password</i>	The access password for the RADIUS accounting server.
<i>RADIUS Acct Port</i>	The port number of the RADIUS accounting server (default is 1813).
<i>Access List</i>	Defines the mode of the client access list: <ul style="list-style-type: none"> <li>• <b>disabled:</b> The access list is not used.</li> <li>• <b>accept:</b> Only clients in the list can access the network.</li> <li>• <b>deny:</b> Clients in the list are blocked from accessing the network.</li> </ul>
<i>Accept/Deny List</i>	A list of client MAC addresses for network access control. Each MAC address should be entered on a new line.

Table 37: Wi-Fi configuration items description (continued)

Item	Description
<i>Syslog Level</i>	Defines the logging level for messages sent to the system log: <ul style="list-style-type: none"><li>• <b>verbose debugging</b>: The highest level of logging.</li><li>• <b>debugging</b></li><li>• <b>informational</b>: The default logging level.</li><li>• <b>notification</b></li><li>• <b>warning</b>: The lowest level of logging.</li></ul>
<i>Extra options</i>	Allows the user to define additional parameters for <code>hostapd</code> . The options are appended to the configuration file. Use this feature only if you are familiar with its functionality. For more information, refer to the <a href="#">hostapd.conf</a> configuration file.

Table 37: Wi-Fi configuration items description (continued)

<sup>1</sup>The availability of certain configuration options may vary depending on the specific Wi-Fi module and can be affected by the selected country code.

WiFi AP 1 Configuration			
<input type="checkbox"/> Enable WiFi AP 1			
Country	all countries		<input type="button" value="Change"/>
<i>APs are not allowed to operate in 5 GHz and 6 GHz frequency bands in world-wide mode.</i>			
IP Address	IPv4	IPv6	
Subnet Mask / Prefix			
Bridged	no		
<input type="checkbox"/> Enable dynamic DHCP leases			
IP Pool Start	IPv4	IPv6	
IP Pool End			
Lease Time	600	600	sec 5-86400 sec
<input type="checkbox"/> Enable IPv6 prefix delegation			
Subnet ID *			
Subnet ID Width *		bits	8-32 bits
SSID			
Broadcast SSID	enabled		
SSID Isolation	disabled		
Client Isolation	disabled		
WMM	disabled		
<i>The following radio settings are common for all Access Points on the WiFi module.</i>			
Follow STA radio settings	<input type="checkbox"/>		
HW Mode	IEEE 802.11b		
Bandwidth	20 MHz		
Channel	Auto		
Short GI	disabled		
Authentication	open		
Encryption	none		
WPA PSK Type	256-bit secret		
WPA PSK Secret			
RADIUS Auth Server IP			
RADIUS Auth Password			
RADIUS Auth Port *	1812		
RADIUS Acct Server IP *			
RADIUS Acct Password *			
RADIUS Acct Port *	1813		
Access List	disabled		
Accept/Deny List			
	<input type="button" value="Load From File..."/>		
Syslog Level	informational		
Extra Options *			

Figure 34: Wi-Fi access point configuration page

### 3.6.2 Station

#### Warning

##### Important Note on Upgrading to Firmware 6.6.0

When upgrading from a firmware version prior to 6.6.0, any separate *Country* settings for the Wi-Fi Access Point (AP) and Station (STA) modes will be consolidated into a single, unified *Country* setting. This change ensures regulatory compliance and simplifies configuration. For more details, please refer to Chapter 3.6.3 *Country*.

#### Info

- You can easily find and connect to an available Wi-Fi network in the GUI. Navigate to *Status* → *Wi-Fi* → *WiFi Scan*, as described in Chapter 2.3.2 *Scan*.
- The router does not support operating as an access point (AP) and a station (STA) at the same time.
- For networks using **WPA-Enterprise** security (RADIUS authentication), the station mode supports only the **EAP-PEAP/MSCHAPv2** (both PEAPv0 and PEAPv1) and **EAP-TLS** authentication methods.

Activate Wi-Fi station mode by checking the *Enable WiFi STA* box at the top of the *Configuration* → *WiFi* → *Station* configuration page. In this mode, the router functions as a client station, connecting to an available access point (AP) and bridging its wired connection to the Wi-Fi network. In station mode, the Wi-Fi channel and bandwidth are determined by the associated access point.

Item	Description
<i>Enable WiFi STA</i>	Enables the Wi-Fi station (STA) mode.
<i>Country</i>	A single Wi-Fi Country code applies to all AP and STA interfaces and is configured on a separate page (accessible via the <i>Change</i> button). After changing the country, you must review your radio settings.
<i>DHCP Client</i>	Activates or deactivates the DHCP client (or DHCPv6 client for IPv6).
<i>IP Address</i>	Specifies a fixed IP address for the Wi-Fi interface. Use standard IPv4 or IPv6 notation.
<i>Subnet Mask / Prefix</i>	Defines the subnet mask for an IPv4 address or the prefix length (0 to 128) for an IPv6 address.
<i>Default Gateway</i>	Specifies the IP address of the default gateway. Packets with destinations not found in the routing table are sent to this gateway.
<i>Primary DNS Server</i>	Specifies the primary IP address of the DNS server.
<i>Secondary DNS Server</i>	Specifies the secondary IP address of the DNS server.
<i>SSID</i>	The unique identifier (name) of the Wi-Fi network to connect to.
<i>Probe Hidden SSID</i>	An access point with a hidden SSID does not broadcast its name, preventing the station from connecting automatically. Enable this option to force the station to probe for a specific hidden SSID. If you are not connecting to a hidden network, keep this disabled to reduce unnecessary radio transmissions.

Table 38: WLAN configuration items description

Item	Description
<i>Authentication</i>	<p>Access control methods for the Wi-Fi network.</p> <ul style="list-style-type: none"> <li>• <b>open</b> – [insecure] No authentication required.</li> <li>• <b>shared</b>: [insecure] Basic authentication with a WEP key.</li> <li>• <b>WPA-PSK</b> – [insecure] Authentication using a PSK with the WPA standard.</li> <li>• <b>WPA2-PSK</b> – [insecure] Authentication using a PSK with the WPA2 standard.</li> <li>• <b>WPA3-PSK</b> – Authentication using SAE with the WPA3 standard.</li> <li>• <b>WPA-Enterprise</b> – [insecure] Authentication using a RADIUS server with the WPA standard.</li> <li>• <b>WPA2-Enterprise</b> – Authentication using a RADIUS server with the WPA2 standard.</li> <li>• <b>WPA3-Enterprise</b> – Authentication using a RADIUS server with the WPA3 standard.</li> </ul>
<i>Encryption</i>	<p>The data encryption method:</p> <ul style="list-style-type: none"> <li>• <b>none</b> – [insecure] No encryption.</li> <li>• <b>WEP</b> – [insecure] Static encryption with WEP keys (insecure and may not be supported).</li> <li>• <b>TKIP</b> – [insecure] Legacy dynamic encryption used with WPA/WPA2.</li> <li>• <b>AES</b> – Modern dynamic encryption used with WPA2/WPA3.</li> </ul>
<i>WPA PSK Type</i>	<p>The format of the key for WPA-PSK authentication:</p> <ul style="list-style-type: none"> <li>• <b>256-bit secret</b> – A 64-character hexadecimal key.</li> <li>• <b>ASCII passphrase</b> – A passphrase of 8 to 63 characters.</li> </ul>
<i>WPA PSK Secret</i>	The secret key or passphrase for WPA-PSK authentication.
<i>RADIUS EAP Authentication</i>	<p>The EAP protocol used for RADIUS authentication:</p> <ul style="list-style-type: none"> <li>• <b>EAP-PEAP/MSCHAPv2</b> – Uses TLS to protect legacy EAP authentication.</li> <li>• <b>EAP-TLS</b> – Uses TLS for mutual authentication between the client and server.</li> </ul>
<i>RADIUS CA Certificate</i>	The Certificate Authority (CA) certificate used to verify the server certificate during EAP-TLS authentication.
<i>RADIUS Local Certificate</i>	The client certificate required for EAP-TLS authentication.
<i>RADIUS Local Private Key</i>	The private key associated with the client certificate for EAP-TLS authentication.
<i>RADIUS Identity</i>	The identity (username) used to connect to the RADIUS server.
<i>RADIUS Password</i>	The password used to authenticate the RADIUS identity (for EAP-PEAP/MSCHAPv2). In the case of EAP-TLS, this field is optional and specifies the decryption key for the local private key if it is encrypted.
<i>Syslog Level</i>	<p>The logging level for system log messages:</p> <ul style="list-style-type: none"> <li>• <b>verbose debugging</b>: The highest level of detail.</li> <li>• <b>debugging</b></li> <li>• <b>informational</b>: The default level.</li> <li>• <b>notification</b></li> <li>• <b>warning</b>: The lowest level of detail.</li> </ul>
<i>Extra options</i>	Allows the user to define additional parameters for <code>wpa_supplicant</code> . The options are appended to the configuration file. Use this feature only if you fully understand the implications. See the <a href="#">wpa_supplicant.conf</a> configuration file for details.

Table 38: WLAN configuration items description (continued)

WiFi STA Configuration	
<input type="checkbox"/> Enable WiFi STA	
Country	all countries <input type="button" value="Change"/>
DHCP Client	IPv4: enabled <input type="button" value="v"/> IPv6: enabled <input type="button" value="v"/>
IP Address	<input type="text"/>
Subnet Mask / Prefix	<input type="text"/>
Default Gateway	<input type="text"/>
Primary DNS Server	<input type="text"/>
Secondary DNS Server	<input type="text"/>
SSID	<input type="text"/>
Probe Hidden SSID	disabled <input type="button" value="v"/>
Authentication	open <input type="button" value="v"/>
Encryption	none <input type="button" value="v"/>
WPA PSK Type	256-bit secret <input type="button" value="v"/>
WPA PSK Secret	<input type="text"/>
RADIUS EAP Authentication	EAP-PEAP/MSCHAPv2 <input type="button" value="v"/>
RADIUS CA Certificate	<input type="text"/>
	<input type="button" value="Choose File"/> No file chosen
RADIUS Local Certificate	<input type="text"/>
	<input type="button" value="Choose File"/> No file chosen
RADIUS Local Private Key	<input type="text"/>
	<input type="button" value="Choose File"/> No file chosen
RADIUS Identity	<input type="text"/>
RADIUS Password	<input type="text"/>
Syslog Level	informational <input type="button" value="v"/>
Extra options *	<input type="text"/>
* can be blank	
<input type="button" value="Apply"/>	

Figure 35: Wi-Fi station configuration page

### 3.6.3 Country

The *Configuration* → *WiFi* → *Country* page is used to set a single, global country code that applies to all Wi-Fi interfaces, including both Access Point (AP) and Station (STA) modes. This setting is crucial for ensuring that the router's radio transmissions comply with the regulatory requirements of the region where it is operated.

From the list, select the appropriate country where the router will be used. For proper and optimal Wi-Fi functionality, **always set the correct country code.**

Alternatively, you can select the *all countries* option. Please note that in this mode, the Access Point (AP) is not permitted to operate in the 5 GHz and 6 GHz frequency bands to ensure broad regulatory compliance.<sup>1</sup>

#### Warning



After selecting a new country, you must click the *Apply* button to save the change. Changing the country code may invalidate previous radio settings (such as *Channel* or *Bandwidth*). As a result, the Wi-Fi AP or STA may fail to operate until it is reconfigured. After changing the country, you must review and re-apply your Wi-Fi AP and STA configurations to ensure they are still valid and that your devices can connect.

#### Info

- 
- On global models, the Country Code selection is limited to *all countries* and *US* only.
  - On North American (NAM) models, this option is not available, as the country code is permanently set to *US* to comply with regional regulations.

<sup>1</sup>If the station (STA) connects to an Access Point (AP) broadcasting a country code different from the *all countries* setting, additional channels may become available in AP mode that are otherwise restricted under the *all countries* configuration.

## 3.7 Backup Routes

The *Backup Routes* feature provides a powerful mechanism for managing WAN (Wide Area Network) connectivity, enabling automatic failover and load balancing across multiple Internet sources. This ensures high availability and optimizes data throughput for critical applications. The configuration is managed on the *Configuration* → *Backup Routes* page.

You can choose to let the router manage WAN connections automatically using its default priorities or customize the behavior to meet specific network requirements.

### Warning

- Some WAN interfaces (e.g., Wi-Fi, secondary Ethernet ports) may not be available on all router models.
- When using default priorities, an Ethernet interface will not be considered a valid WAN connection unless it has a static IP address configured or its DHCP client is enabled.
- In default priority mode, merely unplugging an Ethernet cable will not trigger a failover. The interface must be administratively down or fail to obtain an IP address.

### Default Failover

If the *Enable backup routes switching* option is unchecked, the router uses a predefined, internal priority list to select the active WAN interface. This provides a simple, plug-and-play failover mechanism. The default interface priority is as follows:

1. **Mobile WAN** ( `usb0` or `usb1` )
2. **PPPoE** ( `pppoe0` )
3. **Wi-Fi STA** ( `wlan0` )
4. **ETH0** ( `eth0` )

Based on this order, the router will only use the *ETH1* interface if the Mobile WAN, PPPoE, and Wi-Fi connections are all unavailable. In this mode, it is important to note that a LAN interface (like *ETH0*) can become a WAN interface, which may have security implications. Ensure your firewall and NAT rules are configured accordingly.

### Customized Backup Routes

To gain full control over failover and load balancing, check the *Enable backup routes switching* box. This allows you to define interface priorities, connection checking parameters, and select one of three operational modes.

Backup Routes Configuration			
<input type="checkbox"/> Enable backup routes switching			
Mode	Single WAN ▼		
<input type="checkbox"/> Enable backup routes switching for Mobile WAN			
Priority	1st ▼		
Weight			1-256
<input type="checkbox"/> Enable backup routes switching for PPPoE			
Priority	1st ▼		
Ping IP Address			
Ping IPv6 Address			
Ping Interval		sec	1-86400 sec
Ping Timeout	10	sec	1-86400 sec
Weight			1-256
<input type="checkbox"/> Enable backup routes switching for WiFi STA			
Priority	1st ▼		
Ping IP Address			
Ping IPv6 Address			
Ping Interval		sec	1-86400 sec
Ping Timeout	10	sec	1-86400 sec
Weight			1-256
<input type="checkbox"/> Enable backup routes switching for ETH0			
Priority	1st ▼		
Ping IP Address			
Ping IPv6 Address			
Ping Interval		sec	1-86400 sec
Ping Timeout	10	sec	1-86400 sec
Weight			1-256
<input type="button" value="Apply"/>			

Figure 36: Backup routes configuration page

## Operational Modes

The router offers three distinct modes for managing multiple WAN connections:

Item	Description
<i>Mode</i>	<p>Selects the operational mode for managing WAN interfaces:</p> <ul style="list-style-type: none"> <li>• <b>Single WAN:</b> In this mode, only one WAN interface is active at a time. If the primary interface fails, the system automatically switches to the next available interface based on priority. The router is only accessible from the outside on the currently active WAN interface.</li> <li>• <b>Multiple WANs:</b> This mode is similar to Single WAN, with one key difference: the router is accessible from the outside on all enabled WAN interfaces simultaneously. Failover still occurs one interface at a time.</li> <li>• <b>Load Balancing:</b> This mode allows traffic to be distributed across multiple WAN interfaces simultaneously. You can assign a <i>Weight</i> to each interface to control the proportion of data streams it handles.</li> </ul>

Table 39: Backup route mode descriptions

## Interface Configuration

For each interface you wish to include in the custom backup system, check its *Enable backup routes switching* box and configure the following parameters.

Item	Description
<i>Priority</i>	Sets the priority of the interface (1st is highest). In failover modes, the router will always use the highest-priority active interface.
<i>Ping IP Address</i>	The destination IPv4 address or domain name for ICMP echo requests used to verify connection health.
<i>Ping IPv6 Address</i>	The destination IPv6 address or domain name for ICMP echo requests.
<i>Ping Interval</i>	The time in seconds between each ping test.
<i>Ping Timeout</i>	The time in seconds to wait for a response before considering a ping test to have failed.
<i>Weight</i>	(Load Balancing mode only) A value from 1 to 256 that determines the traffic ratio for this interface. For example, if two interfaces have weights of 4 and 1, they will handle approximately 80% and 20% of the traffic flows, respectively.

Table 40: Backup routes interface configuration

### Warning

- **Load Balancing:** The traffic distribution is based on data streams, not total bandwidth. The actual data volume may not perfectly match the weight ratio, especially with a small number of concurrent connections.
- **Mobile WAN:** To use a cellular connection in a custom backup scenario, you must set *Check Connection* to *enable + bind* on the *Mobile WAN* configuration page.

### Backup Routes Examples

#### Example 1: Default Settings

If no settings are configured on the *Backup Routes* page, the system operates with the default priorities described in Section 3.7. This provides a simple, automatic failover mechanism. Figure 37 shows the default GUI configuration.



Figure 37: GUI configuration for example 1

Figure 38 illustrates the network topology for this example.

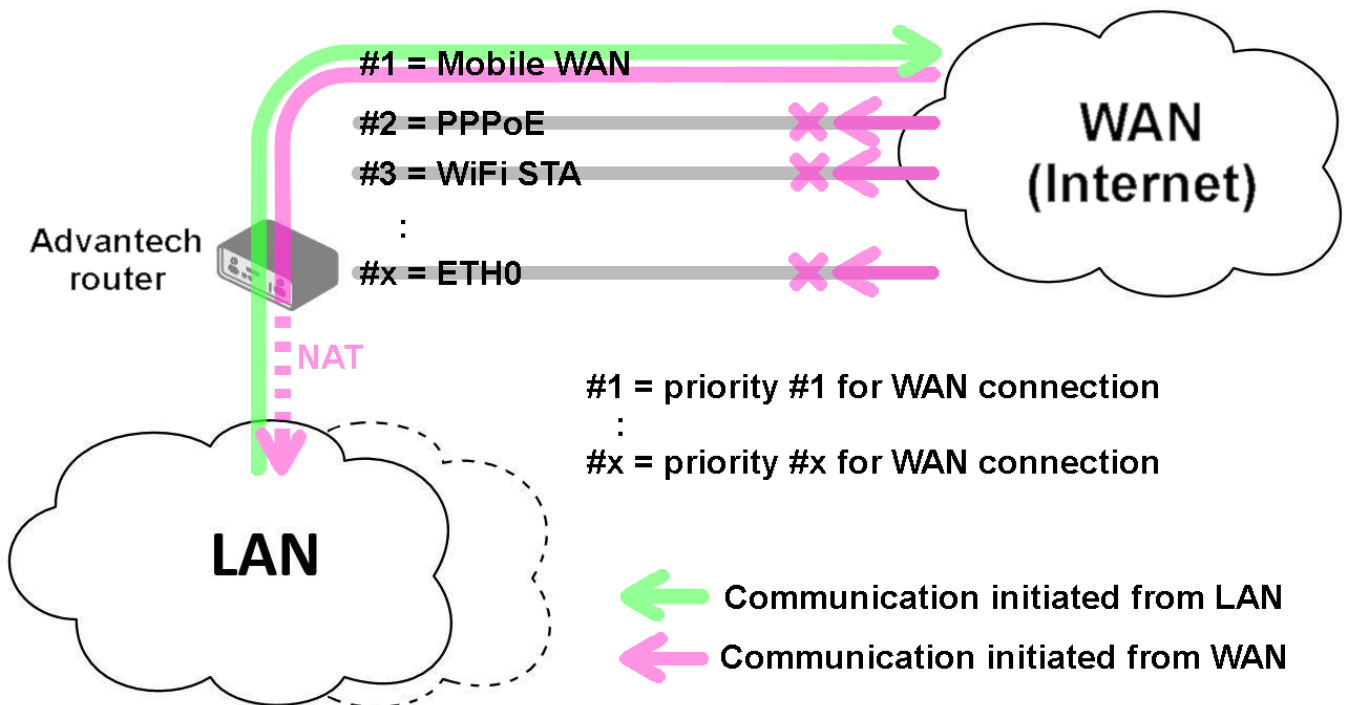

Figure 38: Network topology for example 1

### Example 2: Default Route Switching

This example shows how the default system handles a primary interface failure. If the highest-priority interface (Mobile WAN) becomes unavailable, the router automatically switches to the next interface in the default priority list (PPPoE). The configuration remains untouched, as shown in Figure 39.



Figure 39: GUI configuration for example 2

Figure 40 illustrates the failover scenario.

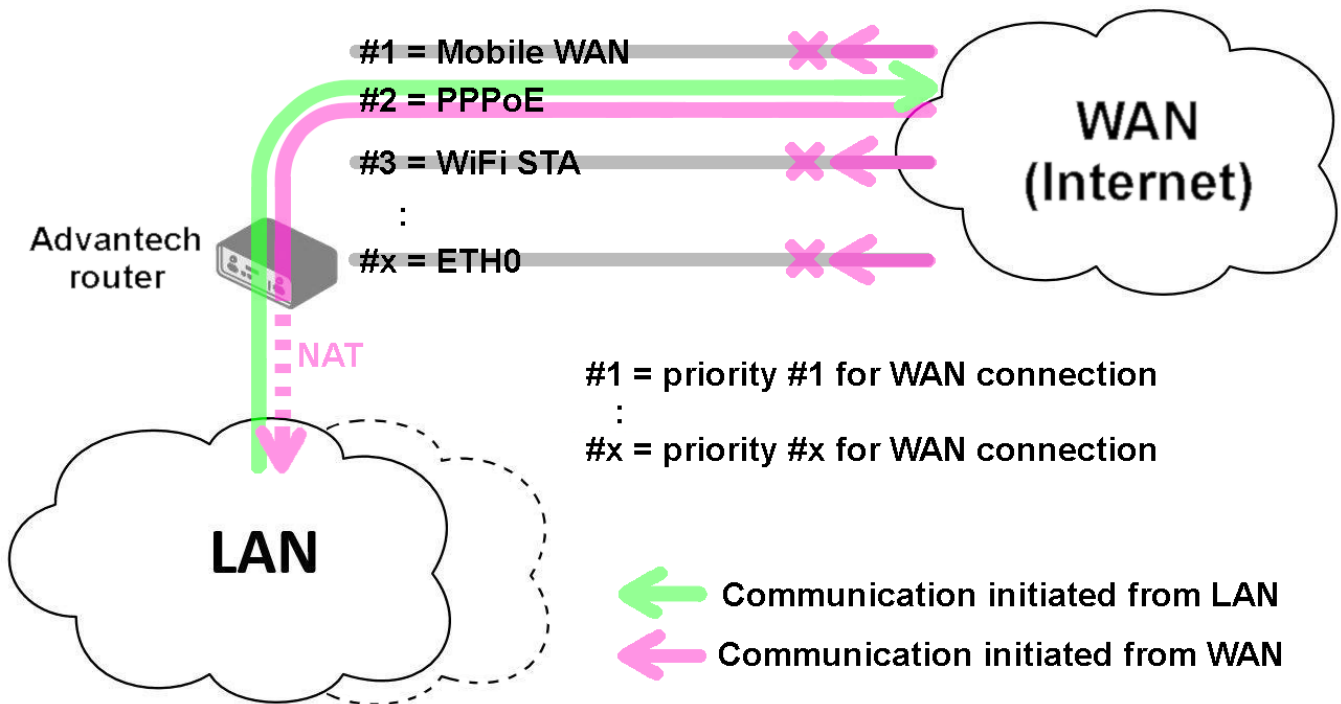

Figure 40: Network topology for example 2

### Example 3: Custom Backup Routes

This example demonstrates a custom failover configuration using the Mobile WAN, PPPoE, and ETH1 interfaces. The Mobile WAN is set as the highest priority, followed by PPPoE, and finally ETH1. The connection status of the PPPoE tunnel is monitored by pinging the IP address 172.16.1.1.

Figure 41 shows the GUI configuration for this scenario.

Backup Routes Configuration			
<input checked="" type="checkbox"/> Enable backup routes switching			
Mode	Single WAN		
<input checked="" type="checkbox"/> Enable backup routes switching for Mobile WAN			
Priority	1st		
Weight			1-256
<input checked="" type="checkbox"/> Enable backup routes switching for PPPoE			
Priority	2nd		
Ping IP Address	172.16.1.1		
Ping IPv6 Address			
Ping Interval	30	sec	1-86400 sec
Ping Timeout	10	sec	1-86400 sec
Weight			1-256
<input type="checkbox"/> Enable backup routes switching for WiFi STA 1			
<input type="checkbox"/> Enable backup routes switching for ETH0			
<input checked="" type="checkbox"/> Enable backup routes switching for ETH1			
Priority	3rd		
Ping IP Address			
Ping IPv6 Address			
Ping Interval		sec	1-86400 sec
Ping Timeout	10	sec	1-86400 sec
Weight			1-256
<input type="button" value="Apply"/>			

Figure 41: GUI configuration for example 3

Figure 42 illustrates the topology for *Single WAN* mode. If the Mobile WAN connection fails, the router will failover to the PPPoE tunnel.

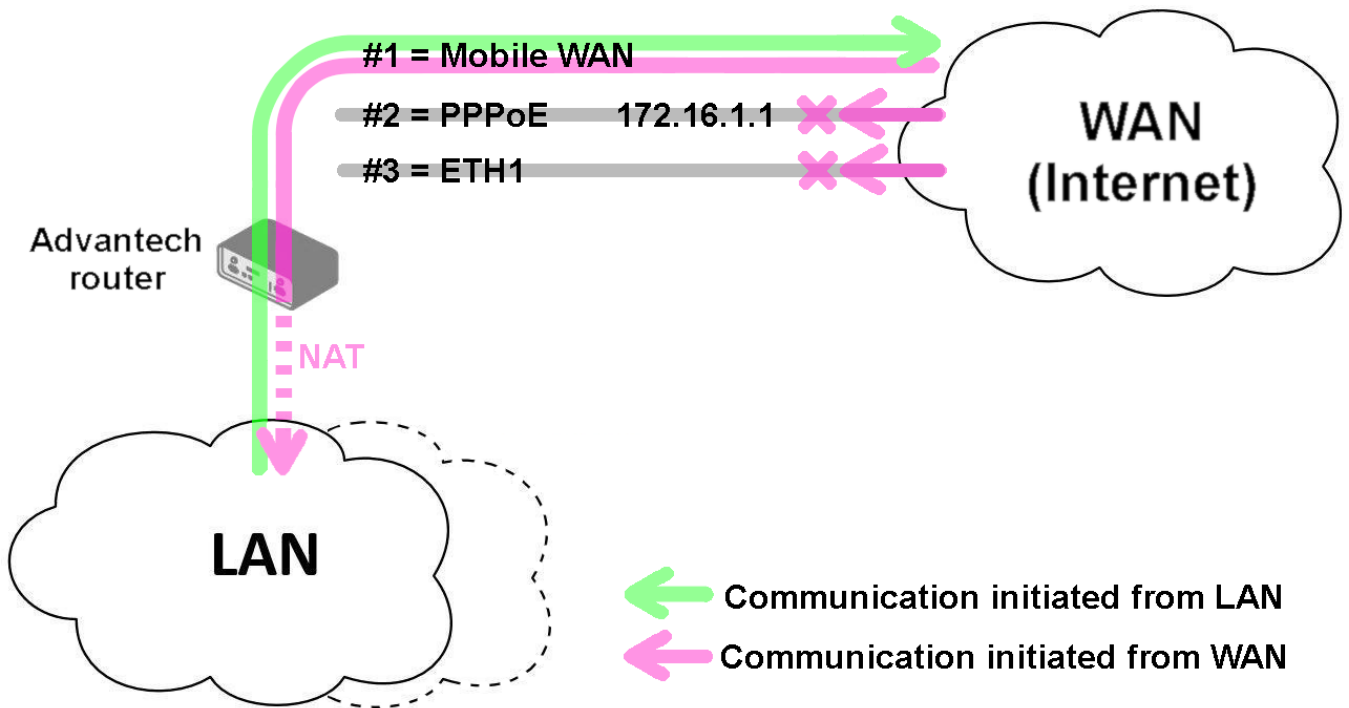

Figure 42: Single WAN mode topology for example 3

Figure 43 shows the same topology in *Multiple WANs* mode. The key difference is that the router can be accessed from the Internet via the public IP addresses of all three interfaces simultaneously, even though only one is used for outbound traffic at a time.

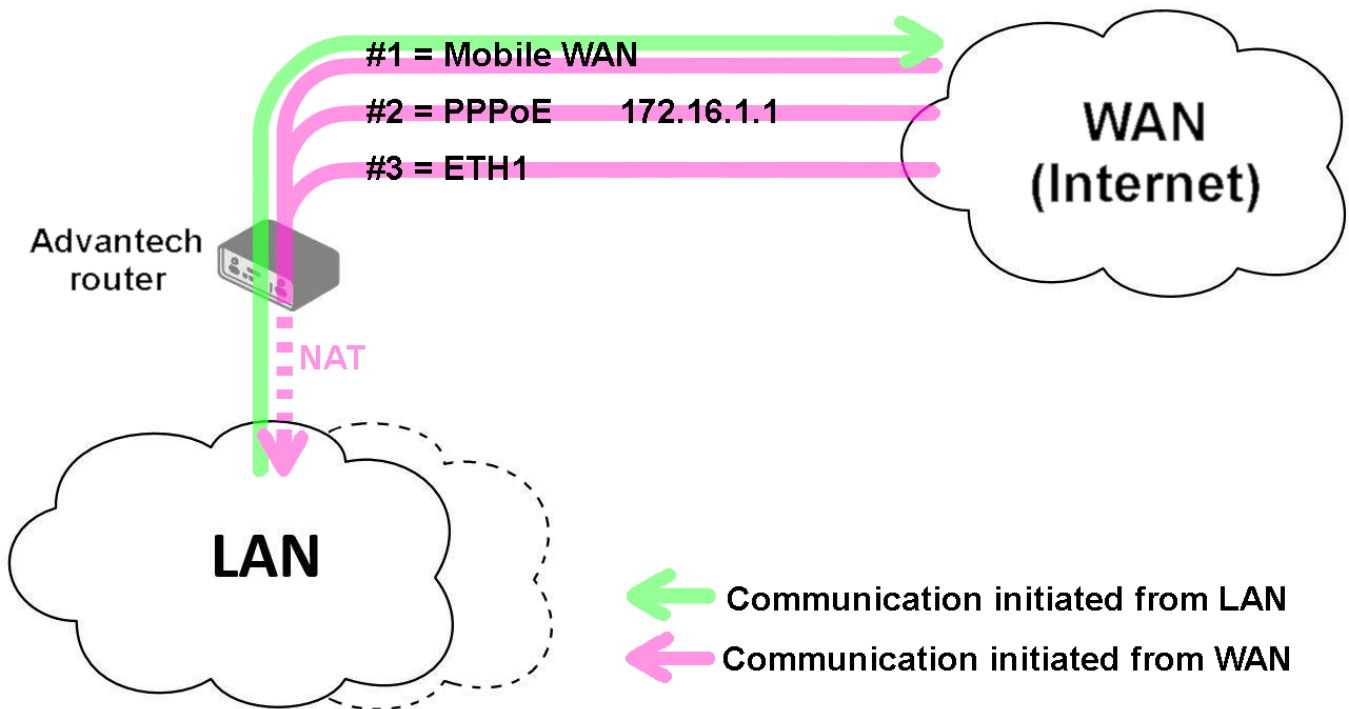

Figure 43: Multiple WANs mode topology for example 3

### Example 4: Load Balancing Mode

This example shows a simple load balancing configuration between the Mobile WAN and a PPPoE interface. The weights are set to 4 and 1, respectively, meaning the Mobile WAN will handle approximately 80% of traffic streams, while the PPPoE interface will handle the remaining 20%. Figure 44 shows the GUI configuration.

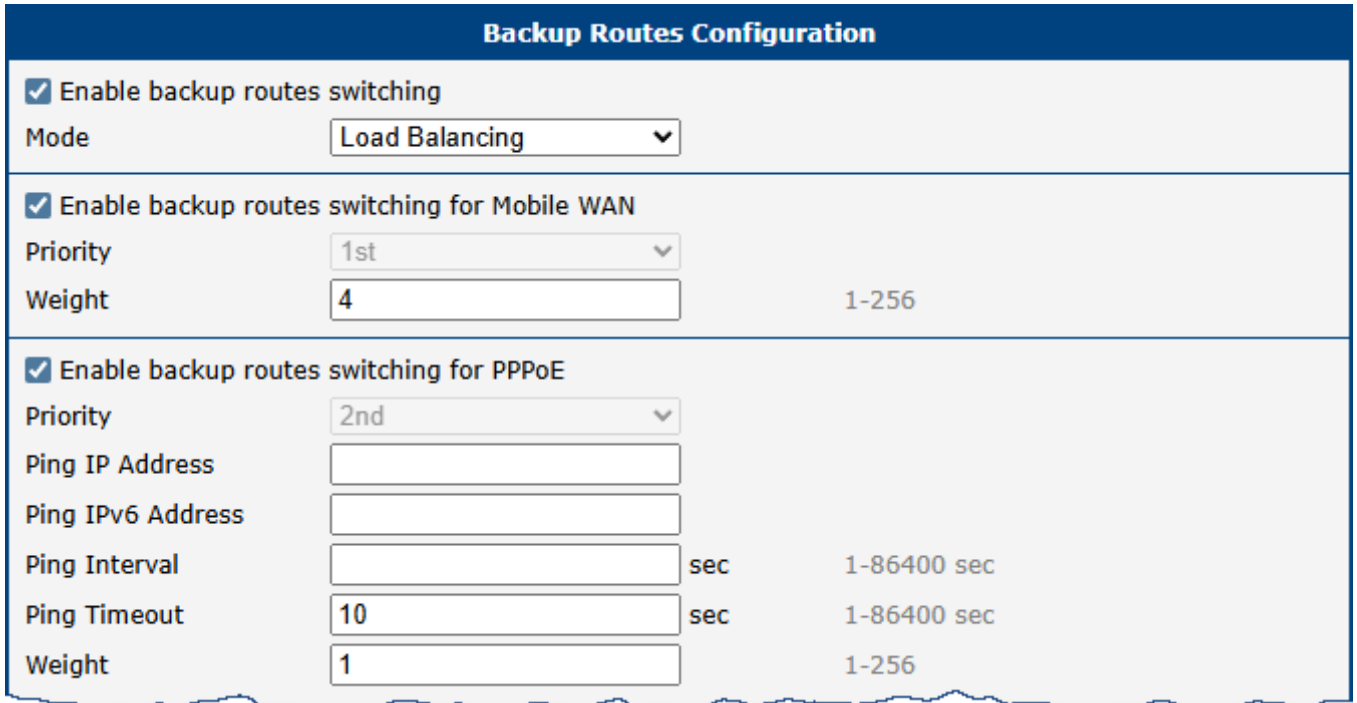

Figure 44: GUI configuration for example 4

Figure 45 illustrates the corresponding network topology.

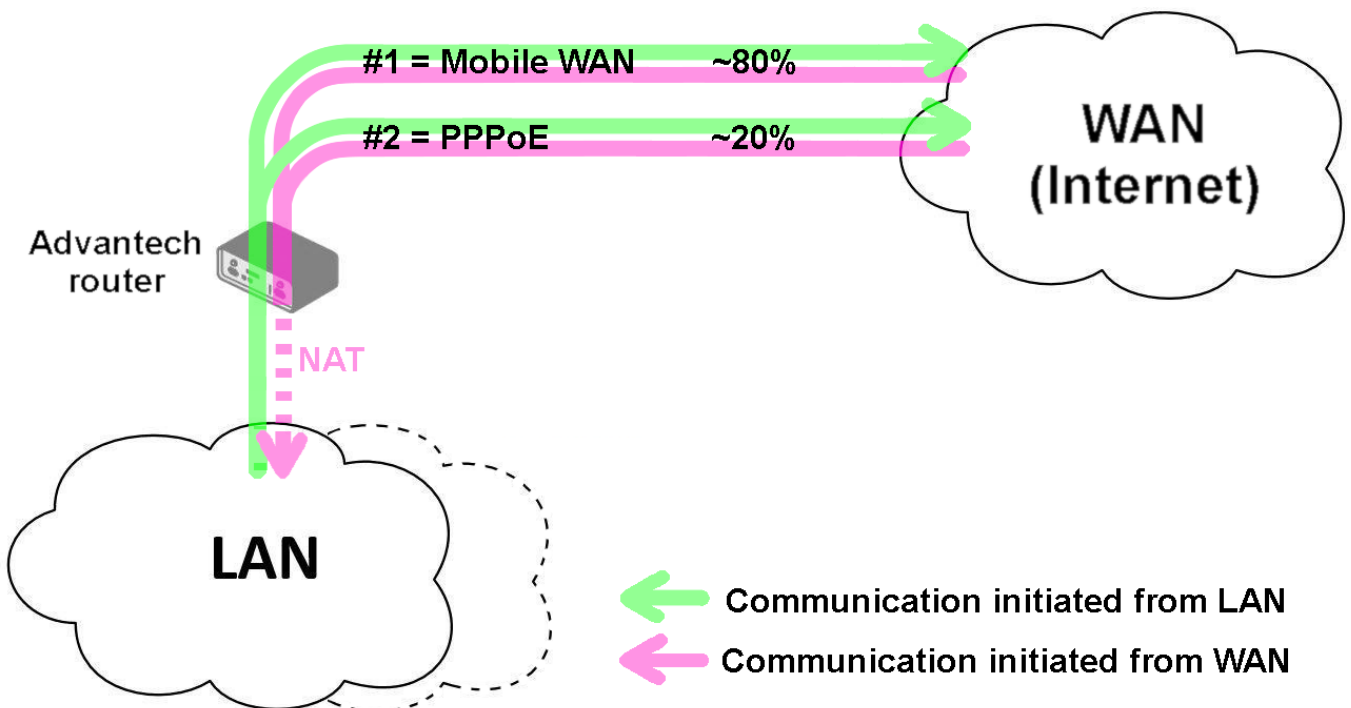

Figure 45: Network topology for example 4

### Example 5: No WAN Routes

If *Backup Routes* is enabled but no interfaces are selected for WAN routing, the router will not have a dedicated WAN connection. In this state, it functions purely as a LAN router, forwarding traffic between its local network segments. The Mobile WAN interface will not be used, even if it is connected to a cellular network. Figure 46 shows this configuration.

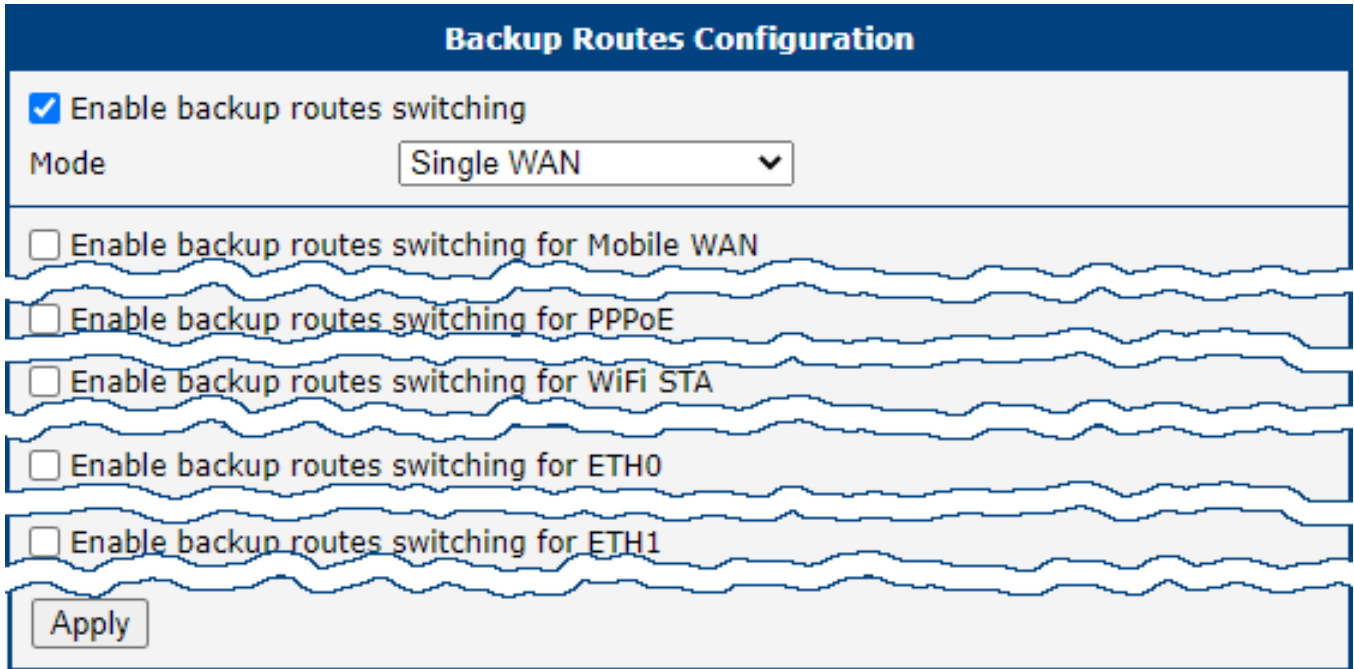

Figure 46: GUI configuration for example 5

Figure 47 illustrates the resulting topology.

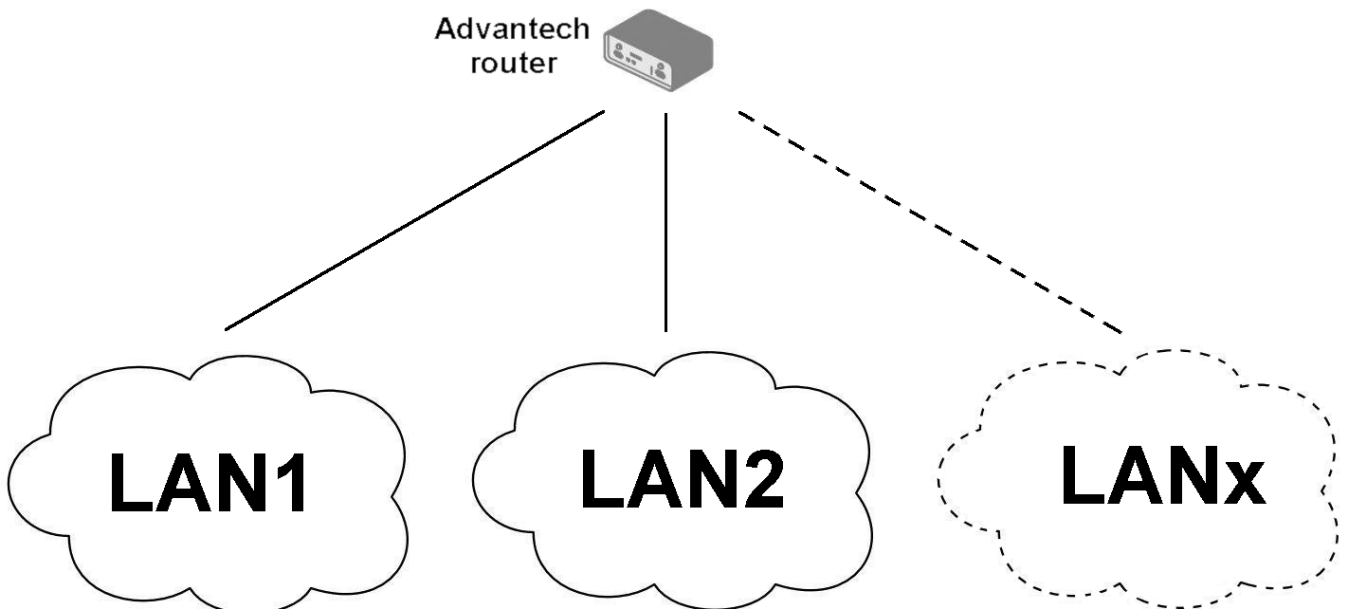

Figure 47: Network topology for example 5

## 3.8 Static Routes

Static routes are manually configured, fixed paths that define how the router should forward traffic to a specific destination network or host. Unlike dynamic routes, which are learned automatically, static routes do not change unless they are manually updated. They are ideal for small, stable networks or for defining a specific path that must always be used.

The configuration is managed on the *Static Routes* page. The router provides separate configuration tables for IPv4 and IPv6, each supporting up to thirty-two individual static routes. A new row is automatically added as you fill in the previous one.

**IPv4 Static Routes Configuration**

Enable IPv4 static routes

	Destination Network	Mask or Prefix Length	Gateway *	Metric *	Interface
1	<input type="text"/>	<input type="text"/>	<input type="text"/>	<input type="text"/>	ETH0
2	<input type="text"/>	<input type="text"/>	<input type="text"/>	<input type="text"/>	ETH0

Maximum: 32 items  
\* can be blank

\* can be blank

Apply

Figure 48: Static routes configuration page

The parameters for defining a static route are described below.

Item	Description
<i>Enable IPv4 static routes</i>	The master switch for the static routing feature. If this is unchecked, all static routes are disabled. Individual routes must also be enabled using the checkbox in their respective rows.
<i>Destination Network</i>	The IP address of the target network or host for which this route is being created.
<i>Mask or Prefix Length</i>	The subnet mask (for IPv4) or prefix length (for IPv6) of the destination network.
<i>Gateway</i>	The IP address of the next-hop router that will be used to reach the destination network.
<i>Metric</i>	A numerical value (1-255) representing the route's priority. A lower metric indicates a more preferred route.
<i>Interface</i> <sup>1</sup>	The network interface through which the specified gateway is reachable.

Table 41: Static routes configuration options

<sup>1</sup>The *Any* option allows for the creation of routes where the gateway may not be directly connected, such as a GRE tunnel endpoint. When *Any* is selected, specifying a *Gateway* is mandatory, as it determines which interface will be used.

### 3.9 Firewall

The router’s firewall allows you to control both incoming and outgoing IP traffic. Supported are independent IPv4 and IPv6 firewalls, including a dual-stack configuration for both protocols. This chapter describes how to configure the firewall rules.



**Info**

**Understanding Firewall Zones**

The router’s firewall simplifies rule creation by grouping network interfaces into two logical zones based on their configured function: **LAN** (trusted) and **WAN** (untrusted). This assignment, not the interface name (e.g., `eth1`, `wlan0`), determines how the firewall treats its traffic.

- **LAN Zone (Trusted):** This zone should contain all interfaces configured for your internal, local network. By default, this typically includes the Ethernet LAN ports (e.g., `eth0`, `eth1`) and any configured Wi-Fi Access Points (`wlanX`).
- **WAN Zone (Untrusted):** This zone should contain all interfaces configured to connect to external networks like the Internet. Common examples include the cellular module (`usb0`), an Ethernet port re-configured for WAN use, or a Wi-Fi client (STA) connection (`wlanX`). For details on configuring backup WAN interfaces, see Chapter 3.7 *Backup Routes*.

**Default Behavior**

By default, the firewall blocks all unsolicited incoming traffic from the WAN zone. Outbound traffic originating from the trusted LAN zone to the untrusted WAN zone is permitted. It is strongly recommended to review and customize the firewall rules to match your specific security requirements.

Clicking the *Firewall* item in the *Configuration* menu on the left expands it into three submenus: *IPv4*, *IPv6*, and *Sites*.

Figure 49 displays the default configuration page for the IPv4 firewall. The configuration fields are identical for both the *IPv4* and *IPv6* forms.

**IPv4 Firewall Configuration**

Enable filtering of incoming packets

#	Source *	Protocol	Target Port(s) *	Action	Description *
1	<input type="text"/>	all	<input type="text"/>	allow	<input type="text"/>
2	<input type="text"/>	all	<input type="text"/>	allow	<input type="text"/>

Maximum 32 items

Enable filtering of forwarded packets

#	Source Address(es) *	Destination Address(es) *	Protocol	Target Port(s) *	Input Interface	Output Interface	Action	Description *
1	<input checked="" type="checkbox"/>	<input type="text"/>	all	<input type="text"/>	LAN	any	allow	Default rule for outgoing connections
2	<input type="checkbox"/>	<input type="text"/>	all	<input type="text"/>	any	any	allow	<input type="text"/>
3	<input type="checkbox"/>	<input type="text"/>	all	<input type="text"/>	any	any	allow	<input type="text"/>

Maximum 32 items

Enable filtering of locally destined packets

Enable protection against DoS attacks

\* can be blank

Figure 49: IPv4 default firewall configuration

## Info

Starting with firmware version 6.6.0, rule descriptions are stored directly as comments in the system's iptables configuration. This allows users to easily identify rules created via the web interface when managing the firewall from the command line (e.g., using `iptables-save`).

The first section of the configuration form defines the **incoming firewall policy**. If the *Enable filtering of incoming packets* checkbox is unchecked, all incoming connections are accepted. When enabled, and if connections originate from the WAN interface, the router checks them against the PREROUTING chain in the mangle table. The router accepts a connection only if a matching rule exists with the *Action* set to *allow*; otherwise, if no matching rule is found or the *Action* is set to *deny*, the connection is dropped.

You can define up to thirty-two rules based on IP addresses, protocols, and ports. Each rule can be enabled or disabled using the checkbox on the left of its row. A new row for the next rule appears automatically after filling in the previous one. See Table 42 for a description of the incoming rule definitions.

Please note that incoming rules apply only to connections originating **from the WAN zone**. For details on priority rules related to WAN interfaces, refer to Chapter 3.7.

Item	Description
<i>Source</i> <sup>1</sup>	Specifies the IP address to which the rule applies. Use an IPv4 address in the <i>IPv4 Firewall Configuration</i> and an IPv6 address in the <i>IPv6 Firewall Configuration</i> .
<i>Protocol</i>	Specifies the protocol to which the rule applies: <ul style="list-style-type: none"> <li>• <b>all</b> – The rule applies to all protocols.</li> <li>• <b>TCP</b> – The rule applies to the TCP protocol.</li> <li>• <b>UDP</b> – The rule applies to the UDP protocol.</li> <li>• <b>GRE</b> – The rule applies to the GRE protocol.</li> <li>• <b>ESP</b> – The rule applies to the ESP protocol.</li> <li>• <b>ICMP/ICMPv6</b> – The rule applies to the ICMP protocol (ICMPv6 for IPv6 firewall).</li> </ul>
<i>Target Port(s)</i>	Specifies the port number or range. Enter a single port or a range separated by a hyphen (e.g., 1020-1040).
<i>Action</i>	Specifies the action the router performs: <ul style="list-style-type: none"> <li>• <b>allow</b> – Permits the packets to enter the network.</li> <li>• <b>deny</b> – Blocks the packets from entering the network.</li> </ul>
<i>Description</i>	A user-defined description for the rule, which is stored as a comment in iptables.

Table 42: Incoming packet filtering

The next section defines the **forwarding firewall policy**. If the *Enable filtering of forwarded packets* checkbox is unchecked, all incoming packets are forwarded. When enabled, and if a packet is addressed to another network interface, the router processes it through the FORWARD chain in iptables. If the FORWARD chain accepts the packet, the router forwards it, provided there is a corresponding entry in the routing table.

You can define up to thirty-two forwarding rules. A new row appears automatically after filling in the previous one. The forwarding settings can be applied to specific interfaces, providing granular control over traffic flow.

<sup>1</sup>This field supports IP address input in the formats: `IP`, `IP/mask`, or `IP_start-IP_end`.

The configuration form includes a table for specifying filter rules. See Table 43 for a description of the forwarding rule definitions.

### Info

As shown in Figure 49, the first entry in the IPv6 forwarded packets configuration is the default firewall rule for NAT64, which is disabled by default. To enable the NAT64 function, navigate to *Configuration* → *NAT* → *IPv6* → *Enable NAT64*.

Item	Description
<i>Source Address(es)</i> <sup>1</sup>	Specifies the source IP address to which the rule applies (IPv4 or IPv6).
<i>Destination Address(es)</i> <sup>1</sup>	Specifies the destination IP address to which the rule applies (IPv4 or IPv6).
<i>Protocol</i>	Specifies the protocol to which the rule applies: <ul style="list-style-type: none"> <li>• <b>all</b>, <b>TCP</b>, <b>UDP</b>, <b>GRE</b>, <b>ESP</b>, <b>ICMP/ICMPv6</b>.</li> </ul>
<i>Target Port(s)</i>	Specifies the target port number or range.
<i>Input Interface</i>	Specifies the interface on which the packet is received. Options include <b>any</b> , WAN zone, LAN zone, or specific interfaces like Ethernet, Bridge, VLAN, Mobile, PPPoE, Wi-Fi, and VPN interfaces.
<i>Output Interface</i>	Specifies the interface through which the packet will be sent. The available options are the same as for the <i>Input Interface</i> .
<i>Action</i>	Defines the action the router performs: <ul style="list-style-type: none"> <li>• <b>allow</b> – Permits the packets to be forwarded.</li> <li>• <b>deny</b> – Blocks the packets from being forwarded.</li> </ul>
<i>Description</i>	A user-defined description for the rule, which is stored as a comment in iptables.

Table 43: Forward packet filtering

When the *Enable filtering of locally destined packets* function is enabled, the router automatically drops packets requesting an unsupported service without sending any notification.

To protect against DoS (Denial of Service) attacks, the *Enable protection against DoS attacks* option limits the number of allowed connections per second to five. A DoS attack floods the target system with excessive requests, overwhelming its resources.

<sup>1</sup>This field supports IP address input in the formats: `IP`, `IP/mask`, or `IP_start-IP_end`.

### Firewall Configuration Example

In this example, the router is configured to permit the following access:

- Access from IP address 198.51.100.45 using any protocol.
- Access from the IP address range 192.0.2.123 to 192.0.3.127 using the TCP protocol on port 1000.
- Access from IP address 203.0.113.67 using the ICMP protocol.
- Access from IP address 203.0.113.67 using the TCP protocol on target ports ranging from 1020 to 1040.

See the network topology and configuration form in the figures below.

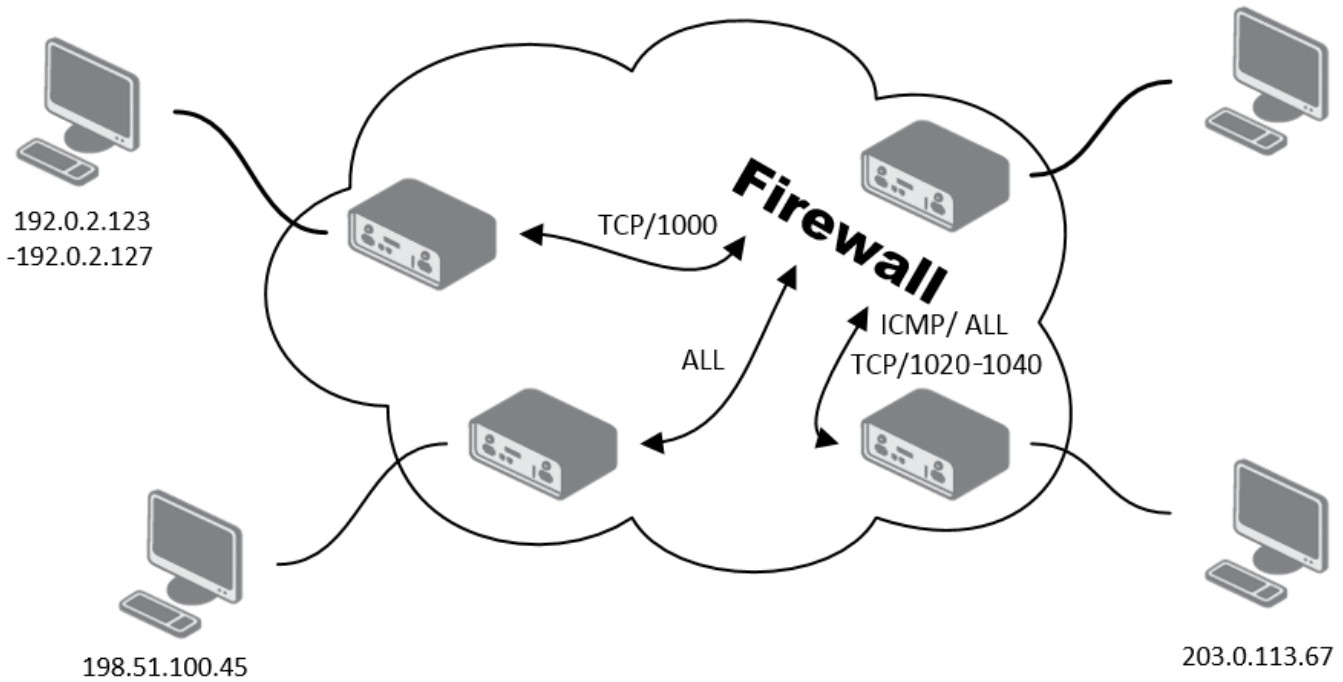

Figure 50: IPv4 firewall configuration topology example

IPv4 Firewall Configuration									
<input checked="" type="checkbox"/> Enable filtering of incoming packets									
	Source *	Protocol	Target Port(s) *	Action	Description *				
1	<input checked="" type="checkbox"/> 198.51.100.45	all		allow					
2	<input checked="" type="checkbox"/> 192.0.2.123-192.0.2.127	TCP	1000	allow					
3	<input checked="" type="checkbox"/> 203.0.113.67	ICMP		allow					
4	<input checked="" type="checkbox"/> 203.0.113.67	TCP	1020-1040	allow					
5	<input type="checkbox"/>	all		allow					
6	<input type="checkbox"/>	all		allow					
Maximum 32 items									
<input type="checkbox"/> Enable filtering of forwarded packets									
	Source Address(es) *	Destination Address(es) *	Protocol	Target Port(s) *	Input Interface	Output Interface	Action	Description *	
1	<input type="checkbox"/>		all		any	any	allow		
2	<input type="checkbox"/>		all		any	any	allow		
Maximum 32 items									
<input type="checkbox"/> Enable filtering of locally destined packets									
<input type="checkbox"/> Enable protection against DoS attacks									
* can be blank									
<input type="button" value="Apply"/>									

Figure 51: IPv4 firewall configuration example

### 3.9.1 Sites

#### Info

This feature works only if the device is using the router as its DNS server.

On the *Sites* configuration page, you can define specific URLs that you want the firewall to block (see Figure 52). To enable this feature, check the *Enable sites blocking* option.

You can then build your blocklist in two ways:

- Manually enter each URL into the *Block list* box, placing each one on a new line.
- Use the *Load From File...* button to import a predefined list of URLs from a plain text file.

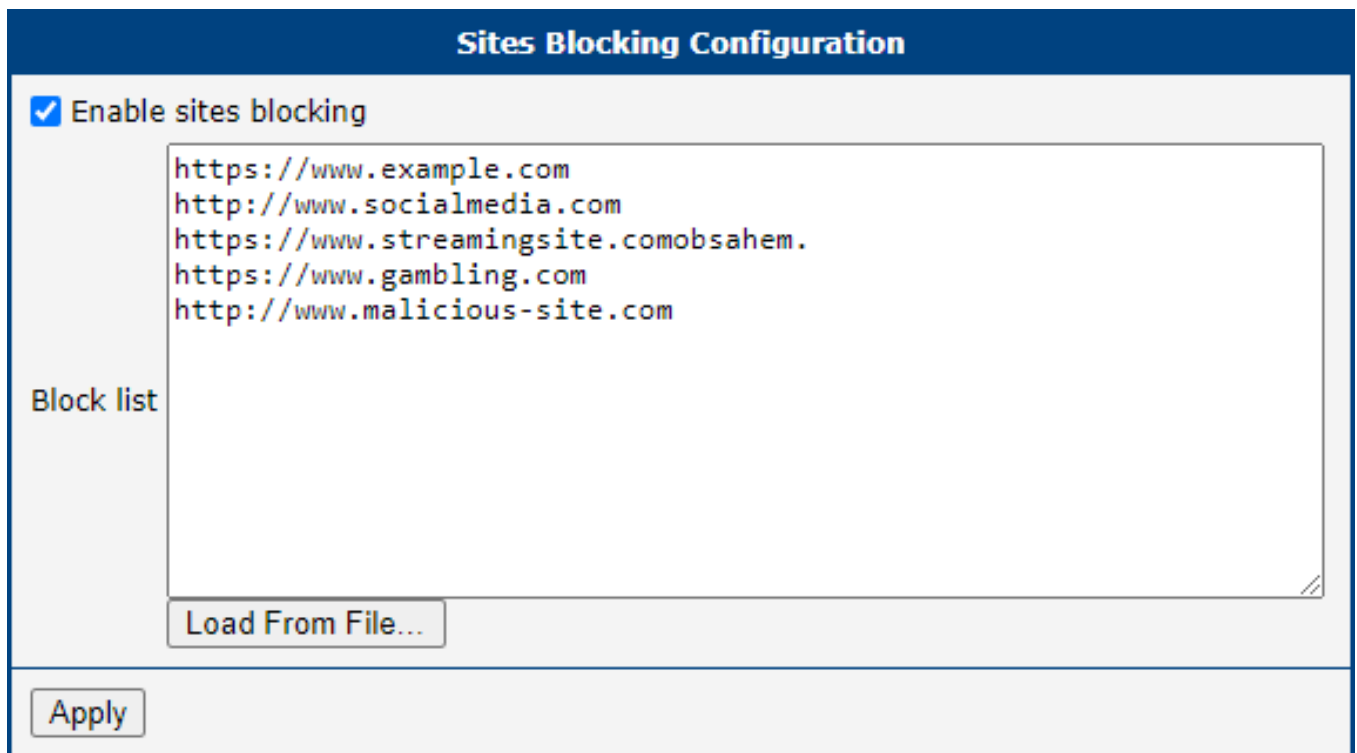

**Sites Blocking Configuration**

Enable sites blocking

Block list

```
https://www.example.com
http://www.socialmedia.com
https://www.streaming-site.com
https://www.gambling.com
http://www.malicious-site.com
```

Load From File...

Apply

Figure 52: Firewall sites configuration page

### 3.10 NAT

Network Address Translation (NAT) is a fundamental networking function that modifies IP address information in packet headers while they are in transit. The router implements NAT (Network Address and Port Translation), also known as PAT (Port Address Translation) or IP masquerading, which allows multiple devices in a private network to share a single public IP address.

The NAT configuration is managed on the *Configuration* → *NAT* page, which has separate subpages for *IPv4* and *IPv6*.

IPv4 NAT Configuration

	Public Port(s)	Private Port(s)	Type	Server IP Address	Description *
1	<input type="text"/>	<input type="text"/>	TCP ▼	<input type="text"/>	<input type="text"/>
2	<input type="text"/>	<input type="text"/>	TCP ▼	<input type="text"/>	<input type="text"/>

Maximum 64 items

Enable remote HTTP access on port

Enable remote HTTPS access on port

Enable remote FTP access on port

Enable remote SSH access on port

Enable remote Telnet access on port

Enable remote SNMP access on port

Send all remaining incoming packets to default server  
 Default Server IP Address

Masquerade outgoing packets  
 Enable SIP ALG  
 Enable FTP Helper on public port(s)   
 Enable PPTP Helper on public port(s)

\* can be blank

Figure 53: NAT IPv4 configuration page

### Port Forwarding

Port forwarding, also known as destination NAT (DNAT), allows external devices to connect to a specific service on a device within the private LAN. You can define up to sixty-four port forwarding rules.

Item	Description
<i>Public Port(s)</i>	The external port or port range on the router’s WAN interface. A single port or a range (e.g., 8000-8010 ) can be specified.
<i>Private Port(s)</i>	The internal port or port range on the destination server.
<i>Type</i>	The protocol for the rule: <i>TCP</i> or <i>UDP</i> .
<i>Server IP Address</i>	The private IPv4 or IPv6 address of the server on the LAN to which traffic will be forwarded.
<i>Description</i>	An optional description for the rule.

Table 44: Port forwarding rule configuration

For configurations requiring more than sixty-four rules, additional rules can be added to the startup script (*Configuration* → *Scripts*). Use the following `iptables` command format for IPv4:

```
iptables -t nat -A pre_nat -p tcp --dport [PORT_PUBLIC] -j DNAT \
--to-destination [IPADDR]:[PORT_PRIVATE]
```

For IPv6, use the `ip6tables` command:

```
ip6tables -t nat -A napt -p tcp --dport [PORT_PUBLIC] -j DNAT \
--to-destination [IP6ADDR]:[PORT_PRIVATE]
```

## Remote Access

This section allows you to enable remote access to the router's own management services from the WAN interface.

Item	Description
<i>Enable remote HTTP access on port</i>	Enables remote access to the router's web interface via HTTP on the specified port. If the HTTP service is disabled in the <i>Services</i> → <i>HTTP</i> configuration while HTTPS is enabled, incoming requests on this port will be automatically redirected to the secure HTTPS interface.
<i>Enable remote HTTPS access on port</i>	Allows secure remote access to the router's web interface via HTTPS on the specified port.
<i>Enable remote FTP access on port</i>	Allows remote access to the router's FTP server on the specified port.
<i>Enable remote SSH access on port</i>	Allows remote access to the router's command-line interface via SSH on the specified port.
<i>Enable remote Telnet access on port</i>	Allows remote access to the router's command-line interface via Telnet on the specified port.
<i>Enable remote SNMP access on port</i>	Allows remote management and monitoring of the router via SNMP on the specified port.

Table 45: Remote access configuration options

### Warning

For secure management, always use HTTPS access. The HTTP remote access option is for redirection only. Exposing unsecured services to the Internet poses a significant security risk and should be avoided.

## Default Server and NAT Helpers

This section contains advanced NAT features, including a “default server” or DMZ setting, and Application-Layer Gateways (ALGs) for specific protocols.

Item	Description
<i>Send all remaining incoming packets to default server</i>	When enabled, all incoming traffic from the WAN that does not match any other port forwarding rule is forwarded to the specified default server. This is often referred to as a DMZ.
<i>Default Server Address</i>	The private IPv4 or IPv6 address of the default server.
<i>Enable NAT64</i>	(IPv6 only) Activates NAT64 translation, allowing IPv6-only clients to communicate with IPv4-only services. Requires a corresponding firewall rule to be effective.
<i>Masquerade outgoing packets</i>	Enables source NAT (SNAT) for all outgoing traffic, making it appear to originate from the router’s public WAN IP address. This should almost always be enabled.
<i>Enable SIP ALG</i>	(IPv4 only) Enables the Session Initiation Protocol Application-Layer Gateway, which helps VoIP traffic traverse NAT by modifying SIP packet headers.
<i>Enable FTP Helper</i>	Assists with NAT traversal for the FTP protocol, particularly for active mode FTP, on the specified port (default is 21).
<i>Enable PPTP Helper</i>	(IPv4 only) Assists with NAT traversal for the Point-to-Point Tunneling Protocol (PPTP) for VPN connections on the specified port (default is 1723).

Table 46: Default server and NAT helper configuration

### Warning

The NAT64 functionality is based on the *Jool* implementation, which has certain limitations. It is not possible to connect to the router itself using its NAT64-mapped IPv4 address (e.g., `64:ff9b::192.0.2.1`). Furthermore, firewall rules for NAT64 traffic must be created in the input chain, not the forward chain, as Jool processes the packets as if they originate from the router itself.

### NAT Configuration Examples

#### Example 1: Forward All Traffic to a Single Device (DMZ)

This configuration forwards all incoming traffic from the Internet to a single device on the LAN, effectively placing it in a Demilitarized Zone (DMZ).

1. Enable the *Send all remaining incoming packets to default server* option.
2. Enter the IP address of the target device in the *Default Server IP Address* field.

The LAN device must be configured to use the router's IP address as its default gateway. With this setup, a ping request to the router's public SIM card IP address will be answered by the device, not the router.

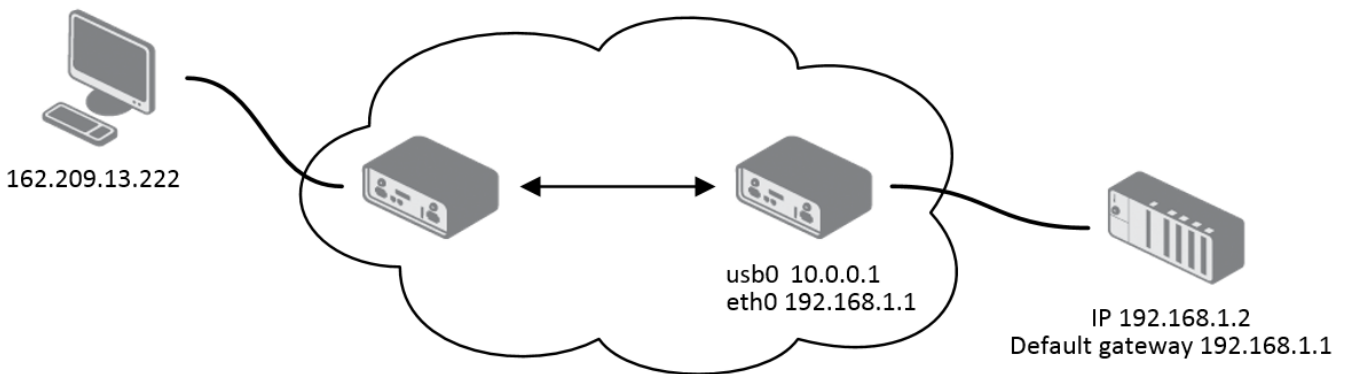

Figure 54: Topology for NAT example 1

IPv4 NAT Configuration					
	Public Port(s)	Private Port(s)	Type	Server IP Address	Description *
1	<input type="text"/>	<input type="text"/>	TCP ▾	<input type="text"/>	<input type="text"/>
2	<input type="text"/>	<input type="text"/>	TCP ▾	<input type="text"/>	<input type="text"/>
Maximum 64 items					
<input type="checkbox"/>	Enable remote HTTP access on port	<input type="text" value="80"/>			
<input type="checkbox"/>	Enable remote HTTPS access on port	<input type="text" value="443"/>			
<input type="checkbox"/>	Enable remote FTP access on port	<input type="text" value="21"/>			
<input type="checkbox"/>	Enable remote SSH access on port	<input type="text" value="22"/>			
<input type="checkbox"/>	Enable remote Telnet access on port	<input type="text" value="23"/>			
<input checked="" type="checkbox"/>	Enable remote SNMP access on port	<input type="text" value="161"/>			
<input checked="" type="checkbox"/>	Send all remaining incoming packets to default server				
	Default Server IP Address	<input type="text" value="192.168.1.2"/>			
<input checked="" type="checkbox"/>	Masquerade outgoing packets				
<input type="checkbox"/>	Enable SIP ALG				
<input checked="" type="checkbox"/>	Enable FTP Helper on public port(s)	<input type="text" value="21"/>			
<input type="checkbox"/>	Enable PPTP Helper on public port(s)	<input type="text" value="1723"/>			
* can be blank					
<input type="button" value="Apply"/>					

Figure 55: NAT configuration for example 1

### Example 2: Port Forwarding to Multiple Devices

This example shows how to make services on multiple internal devices accessible from the Internet using port forwarding. A different public port is mapped to a service on each internal server.

For instance, to make a web server on device `192.168.1.2` (port 80) accessible via public port 81, you would create the following rule:

- **Public Port(s):** 81
- **Private Port(s):** 80
- **Type:** TCP
- **Server IP Address:** 192.168.1.2

External users could then access the web server by navigating to `http://<router_public_ip>:81`. Since the *Send all remaining incoming packets...* option is disabled, any traffic not matching a specific rule will be dropped by the router.

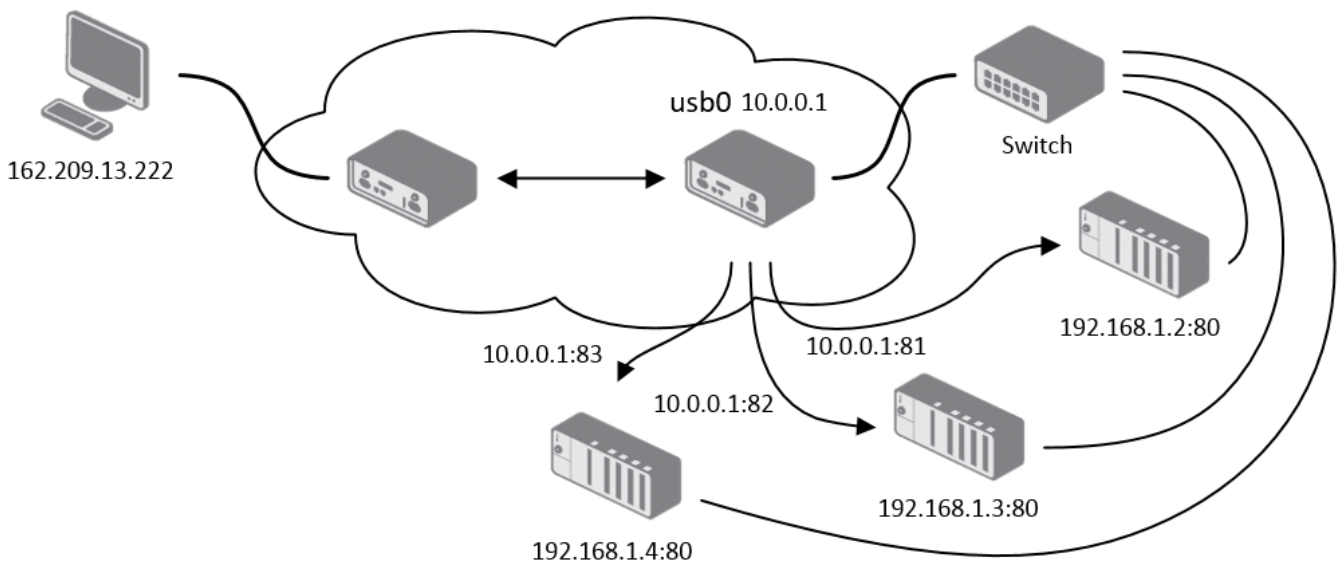

Figure 56: Topology for NAT example 2

IPv4 NAT Configuration					
	Public Port(s)	Private Port(s)	Type	Server IP Address	Description *
1	81	80	TCP	192.168.1.2	
2	82	80	TCP	192.168.1.3	
3	83	80	TCP	192.168.1.4	
Maximum 64 items					
<input type="checkbox"/>	Enable remote HTTP access on port	80			
<input type="checkbox"/>	Enable remote HTTPS access on port	443			
<input type="checkbox"/>	Enable remote FTP access on port	21			
<input type="checkbox"/>	Enable remote SSH access on port	22			
<input type="checkbox"/>	Enable remote Telnet access on port	23			
<input checked="" type="checkbox"/>	Enable remote SNMP access on port	161			
<input type="checkbox"/> Send all remaining incoming packets to default server					
Default Server IP Address <input type="text"/>					
<input checked="" type="checkbox"/> Masquerade outgoing packets					
<input type="checkbox"/> Enable SIP ALG					
<input checked="" type="checkbox"/>	Enable FTP Helper on public port(s)	21			
<input type="checkbox"/>	Enable PPTP Helper on public port(s)	1723			

Figure 57: NAT configuration for example 2

## 3.11 OpenVPN

OpenVPN is a robust and highly flexible Virtual Private Network (VPN) solution that creates secure point-to-point or site-to-site connections over the Internet. The router supports up to four concurrent OpenVPN tunnels, each with its own configuration. Both IPv4 and IPv6 are supported in a dual-stack configuration.

The settings are managed on the *Configuration* → *OpenVPN* page, which contains separate tabs for each tunnel.

1st OpenVPN Tunnel Configuration			
<input type="checkbox"/> Create 1st OpenVPN tunnel			
Description *	<input type="text"/>		
Interface Type	TUN ▼		
Protocol	UDP ▼		
UDP Port	1194		
1st Remote IP Address *	<input type="text"/>		
2nd Remote IP Address *	<input type="text"/>		
Remote Subnet *	<input type="text"/>		
Remote Subnet Mask *	<input type="text"/>		
Redirect Gateway	no ▼		
Local Interface IP Address	<input type="text"/>		
Remote Interface IP Address	<input type="text"/>		
Remote IPv6 Subnet *	<input type="text"/>		
Remote IPv6 Subnet Prefix Length *	<input type="text"/>		
Local Interface IPv6 Address *	<input type="text"/>		
Remote Interface IPv6 Address *	<input type="text"/>		
Ping Interval *	<input type="text"/>	sec	1-86400 sec
Ping Timeout *	<input type="text"/>	sec	1-86400 sec
Renegotiate Interval *	<input type="text"/>	sec	0-86400 sec
Max Fragment Size *	<input type="text"/>	bytes	128-16384 bytes
Compression	LZO ▼		
NAT Rules	not applied ▼		
Authenticate Mode	none ▼		
Security Mode	tls-auth ▼		
Pre-shared Secret	<input type="text"/>		
CA Certificate	<input type="text"/>		
DH Parameters	<input type="text"/>		
Local Certificate	<input type="text"/>		
Local Private Key	<input type="text"/>		
Local Passphrase *	<input type="text"/>		
Username	<input type="text"/>		
Password	<input type="text"/>		
Security Level	0 - Weak ▼		
User's Up Script	<input type="text"/>		
User's Down Script	<input type="text"/>		
Extra Options *	<input type="text"/>		

Figure 58: OpenVPN tunnel configuration page

## Tunnel Configuration

The following tables describe the available parameters for configuring an OpenVPN tunnel.

Item	Description
<i>Description</i>	An optional name or description for the tunnel.
<i>Interface Type</i>	Determines the layer at which the VPN operates: <ul style="list-style-type: none"> <li>• <b>TUN (default)</b>: A routed VPN that operates at the network layer (Layer 3). This is the most common mode.</li> <li>• <b>TAP</b>: A bridged VPN that operates at the data link layer (Layer 2). This requires a bridge to be configured on the corresponding Ethernet interface.</li> </ul>
<i>Protocol</i>	The transport protocol for the VPN tunnel: <ul style="list-style-type: none"> <li>• <b>UDP/UDPv6</b>: Uses UDP for transport. This is generally faster and is the recommended default.</li> <li>• <b>TCP/TCPv6 Server</b>: Uses TCP and configures the router to act as a server, listening for incoming client connections.</li> <li>• <b>TCP/TCPv6 Client</b>: Uses TCP and configures the router to act as a client, initiating a connection to a remote server.</li> </ul>
<i>UDP/TCP port</i>	The port number for the selected protocol. The default is 1194.
<i>1st/2nd Remote IP Address</i>	The IPv4 address, IPv6 address, or domain name of the remote OpenVPN server. A second address can be provided for redundancy.
<i>Remote Subnet</i>	The IPv4 address of the remote network behind the tunnel.
<i>Remote Subnet Mask</i>	The subnet mask of the remote IPv4 network.
<i>Redirect Gateway</i>	If enabled, all of the router's outbound traffic will be sent through the VPN tunnel.
<i>Local/Remote Interface IP Address</i>	The virtual IPv4 addresses for the local and remote endpoints of the tunnel interface itself.
<i>Remote IPv6 Subnet</i>	The IPv6 prefix of the remote network behind the tunnel.
<i>Remote IPv6 Prefix</i>	The prefix length of the remote IPv6 network.
<i>Local/Remote Interface IPv6 Address</i>	The virtual IPv6 addresses for the local and remote endpoints of the tunnel interface.
<i>Ping Interval</i>	The interval in seconds at which keep-alive packets are sent to the remote peer.
<i>Ping Timeout</i>	The time in seconds to wait for a response before considering the tunnel to be down. This value should be greater than the <i>Ping Interval</i> .
<i>Renegotiate Interval</i>	The time in seconds before the session key is renegotiated. This applies to certificate-based authentication modes.
<i>Max Fragment Size</i>	The maximum size in bytes of a packet before it is fragmented.
<i>Compression</i>	Configures data compression for the VPN tunnel. <ul style="list-style-type: none"> <li>• <b>None</b>: [Recommended] No compression is used. This is the most secure setting and avoids any known vulnerabilities.</li> <li>• <b>LZO</b>: [Deprecated] Uses the legacy LZO lossless compression algorithm. <b>This option is insecure due to the VORACLE vulnerability and is pending removal from future OpenVPN versions. Its use is strongly discouraged</b> and it is provided only for backward compatibility with legacy systems.</li> </ul>
<i>NAT Rules</i>	Determines if NAT should be applied to traffic passing through the tunnel.

Table 47: OpenVPN configuration items

## Authentication and Security

OpenVPN offers multiple methods for authentication, allowing for flexible and highly secure configurations.

Item	Description
<i>Authenticate Mode</i>	Selects the method used to authenticate the VPN peers: <ul style="list-style-type: none"> <li>• <b>none</b>: No authentication. Not recommended for production use.</li> <li>• <b>pre-shared secret</b>: Uses a static, pre-shared key for authentication.</li> <li>• <b>username / password</b>: Authenticates using a username, password, and a common CA certificate.</li> <li>• <b>X.509 cert.</b>: Uses a full Public Key Infrastructure (PKI) with certificates for authentication. Can be configured in client, server, or multi-client server mode.</li> </ul>
<i>Security Mode</i>	Configures an additional HMAC layer for verifying control channel packets: <ul style="list-style-type: none"> <li>• <b>tls-auth</b>: Authenticates control channel packets.</li> <li>• <b>tls-crypt</b>: Encrypts and authenticates control channel packets, providing better protection against DoS attacks. This is the recommended mode.</li> </ul>
<i>Pre-shared Secret</i>	The static key used for <i>Pre-shared secret</i> authentication mode or as the HMAC key for <i>Security Mode</i> .
<i>CA Certificate</i>	The certificate of the Certificate Authority that signed the client and server certificates.
<i>DH Parameters</i>	The Diffie-Hellman parameters file, required for server-side X.509 configurations.
<i>Local Certificate</i>	The public certificate for this router.
<i>Local Private Key</i>	The private key corresponding to the local certificate.
<i>Local Passphrase</i>	The passphrase used to protect the local private key file.
<i>Username/Password</i>	The credentials used for the <i>Username/password</i> authentication mode.
<i>Security Level</i> <sup>1</sup>	Sets the minimum cryptographic strength for the connection by controlling which TLS versions and cipher suites are permitted. Higher levels disable older, less secure algorithms. <ul style="list-style-type: none"> <li>• <b>0 - Weak</b>: Allows all cryptographic suites, including insecure legacy algorithms. <b>This level is not recommended and should only be used for compatibility with outdated systems.</b> [Default]</li> <li>• <b>1 - Low</b>: Provides a baseline of 80-bit security.</li> <li>• <b>2 - Medium</b>: Enforces a minimum of 112-bit security.</li> <li>• <b>3 - High</b>: Enforces a minimum of 128-bit security (e.g., requires AES-128 or stronger).</li> <li>• <b>4 - Very High</b>: Enforces a minimum of 192-bit security (e.g., requires AES-192 or stronger).</li> </ul>
<i>User's Up/Down Script</i> <sup>2</sup>	Custom shell scripts that are executed when the tunnel is established or torn down.
<i>Extra Options</i>	A field for adding any additional OpenVPN command-line parameters.

Table 48: Authentication and security options

<sup>1</sup>For a detailed explanation of security levels, see the *Security Guidelines* [15], specifically the chapter on *Cryptographic algorithms*.

<sup>2</sup>The script is passed the following parameters: `cmd tun_dev tun_mtu link_mtu ifconfig_local_ip ifconfig_remote_ip [ init | restart ]`. See the official *OpenVPN Reference Manual* for details on the `-up` option.

**Info**

- An active WAN connection is required for an OpenVPN tunnel to be established, even if the tunnel's traffic is not intended to traverse that WAN.
- When using high security levels with TLS 1.3, it is recommended to use Elliptic Curve (EC) keys instead of RSA keys. Alternatively, you can limit the TLS version to 1.2 by adding `--tls-version-max 1.2` in the *Extra Options* field.

**Configuration Example**

This example shows a basic site-to-site OpenVPN tunnel between two routers, Router A and Router B.

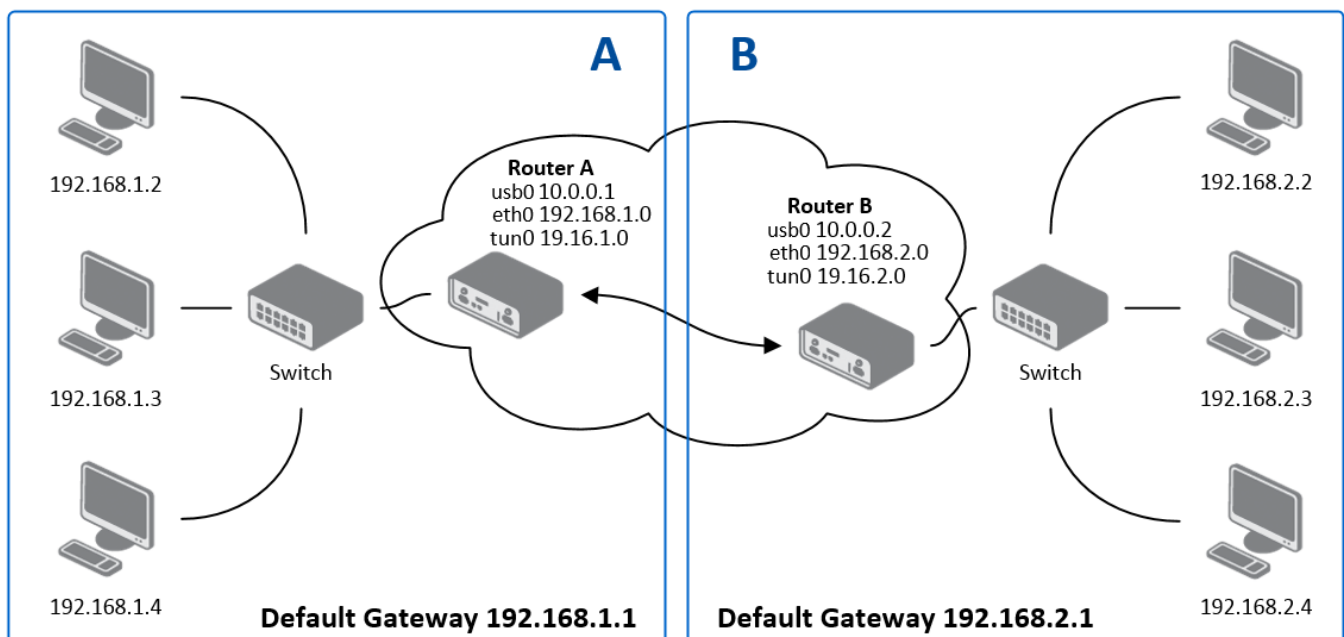

Figure 59: An example of OpenVPN topology

Parameter	Router A	Router B
Protocol	UDP	UDP
UDP Port	1194	1194
Remote IP Address	10.0.0.2	10.0.0.1
Remote Subnet	192.168.2.0	192.168.1.0
Remote Subnet Mask	255.255.255.0	255.255.255.0
Local Interface IP	19.16.1.0	19.16.2.0
Remote Interface IP	19.16.2.0	19.16.1.0
Compression	none	none
Authentication Mode	none	none

Table 49: OpenVPN configuration example

**Info**

For more detailed examples, including certificate-based authentication, please refer to the *OpenVPN Tunnel Application Note* [6].

## 3.12 IPsec

The IPsec tunnel function allows you to create a secure connection between two separate LAN networks. This router family allows you to create up to four IPsec tunnels.

To open the IPsec tunnel configuration page, click *IPsec* in the *Configuration* section of the main menu. The menu item will expand, and you will see separate configuration pages: *1st Tunnel*, *2nd Tunnel*, *3rd Tunnel*, and *4th Tunnel*.

Both **policy-based** and **route-based** VPN approaches are supported—see the different configuration scenarios in Chapter 50.

IPv4 and IPv6 tunnels are supported (**dual stack**). You can transport IPv6 traffic through an IPv4 tunnel and vice versa. For different IPsec authentication scenarios, see Chapter 50.

### Warning

- To encrypt data between the local and remote subnets, specify the appropriate values in the subnet fields on both routers. To encrypt only the data stream between the routers, leave the local and remote subnet fields blank.
- If you specify protocol and port information in the *Local Protocol/Port* field, the router will encapsulate only the packets matching those settings.
- For an optimal and secure setup, we recommend following the instructions on the [Security Recommendations](#) page of the *strongSwan* website.

### Info

- Detailed information and more examples of IPsec tunnel configuration can be found in the application note *IPsec Tunnel* [7].
- The *FRR* Router App is an internet routing protocol suite for Advantech routers. It includes protocol daemons for BGP, IS-IS, LDP, OSPF, PIM, and RIP.

## Policy-based vs. Route-based VPN

The router supports two VPN modes, selectable via the *Type* field on the IPsec configuration page. The key differences are summarized in the table below.

Feature	Policy-based	Route-based
<i>Traffic selection</i>	Subnet pairs defined in <i>Local Subnet</i> and <i>Remote Subnet</i> fields	Routing table entries
<i>Virtual interface</i>	None	<code>ipsecX</code> interface is created
<i>Traffic inspection</i>	Not possible on tunnel traffic	Possible using <code>tcpdump -i ipsecX</code>
<i>Dynamic routing</i>	Not supported	Supported (e.g., FRR/BGP, FRR/OSPF)
<i>Multiple clients</i>	Limited	Fully supported
<i>Cisco FlexVPN</i>	Not supported	Supported
<i>Configuration complexity</i>	Lower	Higher

Table 50: Policy-based vs. route-based IPsec comparison

In **policy-based** mode, the router encrypts traffic based on configured security policies defined by the subnet pairs in *Local Subnet* and *Remote Subnet*. No virtual interface is created — the kernel's policy engine handles encapsulation transparently. This is the simpler approach and is suitable for most standard site-to-site VPN deployments.

In **route-based** mode, a virtual `ipsecX` interface is created for each tunnel. Traffic is routed into the tunnel using standard routing rules, which enables dynamic routing protocols and more flexible topologies. The available route-based scenarios are described in Section 50.

#### Info

When using policy-based mode, if neither *Local Subnet* nor *Remote Subnet* is configured, only router-to-router traffic is encrypted — no LAN-to-LAN traffic will pass through the tunnel.

## Configuration Scenarios

The following scenarios describe the most common VPN topologies supported by Advantech routers. The examples use route-based mode, but — with the exception of scenarios 2 and 3 — they are equally applicable to policy-based mode.

### 1. Enabled Installing Routes

- Remote and local subnets are used as traffic selectors (routes).
- This results in the same outcome as a policy-based VPN.
- A benefit of this approach is the ability to inspect unencrypted traffic on the `ipsecX` interface using a tool like `tcpdump -i ipsecX`.
- Set *Install Routes* to *yes*.

### 2. Static Routes (route-based only)

- Routes are installed statically by an application as soon as the IPsec tunnel is established.
- An application like FRR/STATICD can be used for this purpose.
- Set *Install Routes* to *no*.

### 3. Dynamic Routing (route-based only)

- Routes are installed dynamically by a routing protocol application, such as FRR/BGP or FRR/OSPF.
- Set *Install Routes* to *no*.

### 4. Multiple Clients

- This allows for a VPN network with multiple clients. One router acts as the server and assigns IP addresses to all clients.
- The server has *Remote Virtual Network* and *Remote Virtual Mask* configured, while clients use the *Local Virtual Address* setting.
- Set *Install Routes* to *yes*.

## IPsec Authentication Scenarios

Four basic authentication options are supported:

### 1. Pre-shared Key

- Set *Authenticate Mode* to *pre-shared key*.
- Enter the shared key into the *Pre-shared Key* field.

### 2. Public Key

- Set *Authenticate Mode* to *X.509 certificate*.
- Enter the public key into the *Local Certificate / PubKey* field.
- A CA certificate is not required.

### 3. Peer Certificate

- Set *Authenticate Mode* to *X.509 certificate*.
- Enter the remote key into the *Remote Certificate / PubKey* field. Users with this certificate will be allowed.
- A CA certificate is not required.

### 4. CA Certificate

- Set *Authenticate Mode* to *X.509 certificate*.
- Enter the CA certificate(s) into the *CA Certificate* field. Any certificate signed by the specified CA will be accepted.
- The remote certificate itself is not required.

#### Notes:

- The Peer and CA Certificate modes can be used simultaneously; authentication can be performed by either method.
- The *Local ID* is significant. When using certificate authentication, the IKE identity must be contained in the certificate, either as its subject or as a `subjectAltName`.

## Configuration Items

The IPsec configuration GUI is shown in Figure 60, and all items are described in the tables below.

1st IPsec Tunnel Configuration			
<input type="checkbox"/> Create 1st IPsec tunnel			
Description *	<input type="text"/>		
Type	policy-based ▼		
Host IP Mode	IPv4 ▼		
1st Remote IP Address *	<input type="text"/>		
2nd Remote IP Address *	<input type="text"/>		
Tunnel IP Mode	IPv4 ▼		
Local ID *	<input type="text"/>		
Remote ID *	<input type="text"/>		
Local Protocol/Port *	<input type="text"/>		
Remote Protocol/Port *	<input type="text"/>		
Install Routes	yes ▼		
Separate Child SA for Each Subnet	<input type="checkbox"/>		
	Local Subnet *	Local Subnet Mask	Remote Subnet *
1	<input type="text"/>	<input type="text"/>	<input type="text"/>
2	<input type="text"/>	<input type="text"/>	<input type="text"/>
Maximum 10 items			
MTU	<input type="text" value="1426"/>	bytes	1280-1443 bytes
Remote Virtual Network *	<input type="text"/>		
Remote Virtual Mask *	<input type="text"/>		
Local Virtual Address *	<input type="text"/>		
Cisco FlexVPN **	no ▼		
Encapsulation Mode	tunnel ▼		
Force NAT Traversal	no ▼		
IKE Protocol	IKEv1 ▼		
IKE Mode	main ▼		
IKE Algorithm	auto ▼		
IKE Encryption	3DES ▼		
IKE Hash	MD5 ▼		
IKE DH Group	2 (modp1024) ▼		
IKE Reauthentication	yes ▼		
XAUTH Enabled	no ▼		
XAUTH Mode	client ▼		
XAUTH Username	<input type="text"/>		
XAUTH Password	<input type="password"/>		

Figure 60: IPsec tunnels configuration page – part 1

ESP Algorithm	<input type="text" value="auto"/>	▼	
ESP Encryption	<input type="text" value="DES"/>	▼	
ESP Hash	<input type="text" value="MD5"/>	▼	
PFS	<input type="text" value="disabled"/>	▼	
PFS DH Group	<input type="text" value="2 (modp1024)"/>	▼	
Key Lifetime	<input type="text" value="3600"/>	sec	1-86400 sec
IKE Lifetime	<input type="text" value="3600"/>	sec	1-86400 sec
Lifetime Margin	<input type="text" value="540"/>	sec	1-86400 sec
Lifetime Fuzz	<input type="text" value="100"/>	%	0-200%
DPD Delay *	<input type="text"/>	sec	1-3600 sec
DPD Timeout *	<input type="text"/>	sec	1-3600 sec
Authenticate Mode	<input type="text" value="pre-shared key"/>	▼	
Pre-shared Key	<input type="text"/>	👁	
Remote Pre-shared Key *	<input type="text"/>		
CA Certificate *	<input type="text"/>		
	<input type="button" value="Choose File"/>	No file chosen	
Remote Certificate / PubKey *	<input type="text"/>		
	<input type="button" value="Choose File"/>	No file chosen	
Local Certificate / PubKey	<input type="text"/>		
	<input type="button" value="Choose File"/>	No file chosen	
Local Private Key	<input type="text"/>		
	<input type="button" value="Choose File"/>	No file chosen	
Local Passphrase *	<input type="text"/>		
Revocation Check	<input type="text" value="if possible"/>	▼	
User's Up Script	<input type="text" value="#!/bin/sh\n#\n# This script will be executed when IPsec tunnel is up."/>		
	<input type="button" value="Load From File..."/>		
User's Down Script	<input type="text" value="#!/bin/sh\n#\n# This script will be executed when IPsec tunnel is down."/>		
	<input type="button" value="Load From File..."/>		
Debug **	<input type="text" value="control"/>	▼	

Figure 61: IPsec tunnels configuration page – part 2

Item	Description
<i>Description</i>	A user-defined name or description for the tunnel.
<i>Type</i>	<ul style="list-style-type: none"> <li>• <b>policy-based</b> – Standard VPN approach based on security policies.</li> <li>• <b>route-based</b> – VPN approach based on routing rules. Data throughput may be slightly lower compared to policy-based VPN.</li> </ul>
<i>Host IP Mode</i>	<ul style="list-style-type: none"> <li>• <b>IPv4</b> – The router communicates with the remote peer using IPv4.</li> <li>• <b>IPv6</b> – The router communicates with the remote peer using IPv6.</li> </ul>
<i>1st Remote IP Address</i>	The primary IPv4, IPv6 address, or domain name of the remote peer, corresponding to the selected <i>Host IP Mode</i> .
<i>2nd Remote IP Address</i>	The secondary (failover) IPv4 or IPv6 address, or domain name, of the remote peer. If configured, failover works as follows: at startup, the router initiates a connection to the <i>1st Remote IP Address</i> . If that connection fails, the router attempts to connect to the <i>2nd Remote IP Address</i> . Once the secondary connection is established, the router continues to use it until it fails — it does not automatically switch back to the primary address while the secondary connection is active.
<i>Tunnel IP Mode</i>	<ul style="list-style-type: none"> <li>• <b>IPv4</b> – IPv4 traffic is transported inside the tunnel.</li> <li>• <b>IPv6</b> – IPv6 traffic is transported inside the tunnel.</li> </ul>
<i>Local ID</i>	The identifier (ID) for the local side of the tunnel, typically composed of a hostname and a domain name (e.g., <code>router@mycompany.com</code> ).
<i>Remote ID</i>	The identifier (ID) for the remote side of the tunnel.
<i>Local Protocol/Port</i>	Narrows the traffic selector by specifying the protocol and port for the local network. The format is <i>protocol/port</i> (e.g., <code>17/1701</code> for UDP port 1701).
<i>Remote Protocol/Port</i>	Narrows the traffic selector by specifying the protocol and port for the remote network.
<i>Install Routes</i>	For route-based mode only. If set to <b>yes</b> , the router automatically uses the traffic selectors to create and install routes.
<i>Separate Child SA for Each Subnet</i>	If enabled, a unique Child Security Association (SA) is created for each pair of local and remote subnets. This can improve interoperability with certain vendors and allow for more granular traffic policies. If disabled, a single Child SA covers all defined traffic selectors.
<i>Local Subnet</i>	The IPv4 or IPv6 address of the local network, based on the selected <i>Tunnel IP Mode</i> .
<i>Local Subnet Mask</i>	The IPv4 subnet mask or IPv6 prefix length (0–128) for the local network.
<i>Remote Subnet</i>	The IPv4 or IPv6 address of the network behind the remote peer.
<i>Remote Subnet Mask</i>	The IPv4 subnet mask or IPv6 prefix length for the remote network.
<i>MTU</i>	The Maximum Transmission Unit for the tunnel in route-based mode. The default value is 1426 bytes.
<i>Remote Virtual Network</i>	Specifies the virtual remote network for a server (responder).
<i>Remote Virtual Mask</i>	Specifies the virtual remote network mask for a server.
<i>Local Virtual Address</i>	Specifies the virtual local network address for a client. Use 0.0.0.0 to have an address assigned by the server.
<i>Cisco FlexVPN</i>	Enable to support Cisco FlexVPN functionality (route-based type only).
<i>Encapsulation Mode</i>	Specifies the IPsec encapsulation method: <ul style="list-style-type: none"> <li>• <b>tunnel</b> – The entire IP datagram is encapsulated.</li> <li>• <b>transport</b> – Only the IP header is encapsulated (not supported for route-based VPN).</li> </ul>
<i>Force NAT Traversal</i>	Enforces NAT traversal by enabling UDP encapsulation of ESP packets.

Table 51: IPsec tunnel configuration items description

Item	Description
<i>IKE Protocol</i>	Specifies the version of the Internet Key Exchange (IKE) protocol: <b>IKEv1/IKEv2</b> (auto-negotiate), or explicitly <b>IKEv1</b> or <b>IKEv2</b> . When set to IKEv1/IKEv2, the router first attempts to negotiate using IKEv2. If the peer does not support IKEv2, the router automatically falls back to IKEv1. IKEv2 is strongly recommended whenever possible, as it provides improved security and enhanced functionality.
<i>IKE Mode</i>	Specifies the mode for establishing a connection: <i>main</i> or <i>aggressive</i> . <b>It is strongly recommended not to use aggressive mode due to lower security.</b>
<i>IKE Algorithm</i>	Specifies how algorithms are selected: <ul style="list-style-type: none"> <li>• <b>auto</b> – Encryption and hash algorithms are selected automatically.</li> <li>• <b>manual</b> – Algorithms are defined by the user.</li> </ul>
<i>IKE Encryption</i>	Available encryption algorithms: <b>3DES, AES128, AES192, AES256, AES128GCM128, AES192GCM128, AES256GCM128.</b>
<i>IKE Hash</i>	Available hash algorithms: <b>MD5, SHA1, SHA256, SHA384, SHA512.</b>
<i>IKE DH Group</i>	Selects the Diffie-Hellman (DH) group, which determines the strength of the key used in the key exchange process. The choice of group is a trade-off between security and performance, as stronger groups require more computation. For detailed guidance on selecting an appropriate group, please refer to the official <a href="#">Algorithm Proposals (Cipher Suites)</a> .
<i>IKE Reauthentication</i>	Enable or disable IKE reauthentication (for IKEv2 only).
<i>XAUTH Enabled</i>	Enable eXtended Authentication (for IKEv1 only).
<i>XAUTH Mode</i>	Select the XAUTH mode: <i>client</i> or <i>server</i> .
<i>XAUTH Username</i>	The username for XAUTH.
<i>XAUTH Password</i>	The password for XAUTH.
<i>ESP Algorithm</i>	Specifies how algorithms are selected: <ul style="list-style-type: none"> <li>• <b>auto</b> – Encryption and hash algorithms are selected automatically.</li> <li>• <b>manual</b> – Algorithms are defined by the user.</li> </ul>
<i>ESP Encryption</i>	Available encryption algorithms: <b>DES, 3DES, AES128, AES192, AES256, AES128GCM128, AES192GCM128, AES256GCM128, CAMELLIA192, CAMELLIA256, CHACHA20POLY1305.</b>
<i>ESP Hash</i>	Available hash algorithms: <b>MD5, SHA1, SHA256, SHA384, SHA512.</b>
<i>PFS</i>	Enables or disables Perfect Forward Secrecy, which ensures that session keys are not compromised if one of the long-term private keys is compromised.
<i>PFS DH Group</i>	Specifies the Diffie-Hellman group for PFS (see <i>IKE DH Group</i> ).
<i>Key Lifetime</i>	Specifies the maximum interval after which a new set of encryption keys is automatically negotiated. The typical value is a few hours. The connection remains uninterrupted.
<i>IKE Lifetime</i>	Specifies the time period after which the router must re-authenticate the connection. The typical value ranges from a few hours to several days and must be greater than <i>Key Lifetime</i> . The entire connection is re-established, and a brief interruption may occur.
<i>Lifetime Margin</i>	Specifies how long before <i>Key Lifetime</i> or <i>IKE Lifetime</i> expires the router should initiate rekeying or reauthentication, to ensure the process completes within the lifetime interval. This value should be less than half of <i>Key Lifetime</i> and <i>IKE Lifetime</i> .

Table 51: IPsec tunnel configuration items description (continued)

Item	Description
<i>Lifetime Fuzz</i>	Specifies a percentage used to calculate a random time offset added to <i>Life-time Margin</i> . This introduces random variation in each rekeying and reauthentication cycle to prevent multiple devices from synchronizing their requests.
<i>DPD Timeout</i>	The period the router waits for a DPD response before considering the peer to be down.
<i>Authenticate Mode</i>	Specifies the authentication method: <ul style="list-style-type: none"> <li>• <b>Pre-shared key</b> – Use a shared secret for both sides.</li> <li>• <b>X.509 Certificate</b> – Use X.509 certificates for authentication.</li> </ul>
<i>Pre-shared Key</i>	The shared secret for both sides of the tunnel (for IKEv2, this is the local key). This field appears only when pre-shared key mode is selected.
<i>Remote Pre-shared Key</i>	The shared secret for the remote side (for IKEv2). Appears only when pre-shared key mode is selected.
<i>CA Certificate</i>	The CA certificate or chain used for X.509 authentication to validate the remote peer's certificate.
<i>Remote Certificate / PubKey</i>	The remote peer's X.509 certificate or public key for signature-based authentication.
<i>Local Certificate / PubKey</i>	The local router's X.509 certificate or public key.
<i>Local Private Key</i>	The private key corresponding to the local certificate.
<i>Local Passphrase</i>	The passphrase used during private key generation.
<i>Revocation Check</i>	Certificate revocation policy: <ul style="list-style-type: none"> <li>• <b>if possible</b> – Fails only if a certificate is known to be revoked.</li> <li>• <b>if URI defined</b> – Fails if a CRL/OCSP URI is available, but revocation checking fails.</li> <li>• <b>always</b> – Fails if no revocation information is available (certificate is not known to be unrevoked).</li> </ul>
<i>User's Up Script<sup>1</sup></i>	A custom script executed when the IPsec tunnel is established.
<i>User's Down Script<sup>1</sup></i>	A custom script executed when the IPsec tunnel is closed.
<i>Debug</i>	Controls the level of logging verbosity: <ul style="list-style-type: none"> <li>• <b>silent</b> – No logging.</li> <li>• <b>audit</b> – Logs only successful connections and disconnections.</li> <li>• <b>control</b> – Default level, logs normal messages and errors.</li> <li>• <b>control-more</b> – More verbose control messages.</li> <li>• <b>raw</b> – Logs raw protocol messages.</li> <li>• <b>private</b> – Most verbose level, including private keys.</li> </ul> See the <a href="#">Logger Configuration</a> page on the <i>strongSwan</i> website for details.

Table 51: IPsec tunnel configuration items description (continued)

We recommend retaining the default settings. Increasing key lifetimes reduces operational costs but also decreases security. Conversely, shorter lifetimes increase security but may affect performance. Changes are applied after clicking the *Apply* button.

### Important Considerations

#### Warning

- If local and remote subnets are not configured, only router-to-router traffic is encrypted.
- If protocol/port fields are configured, only traffic matching those settings is encapsulated.

<sup>1</sup>Parameters passed to the script: for policy-based, the connection name (e.g., `ipsec1-1`); for route-based, the connection name and interface name (e.g., `ipsec1-1` and `ipsec0`).

## IPsec Tunnel Configuration Example

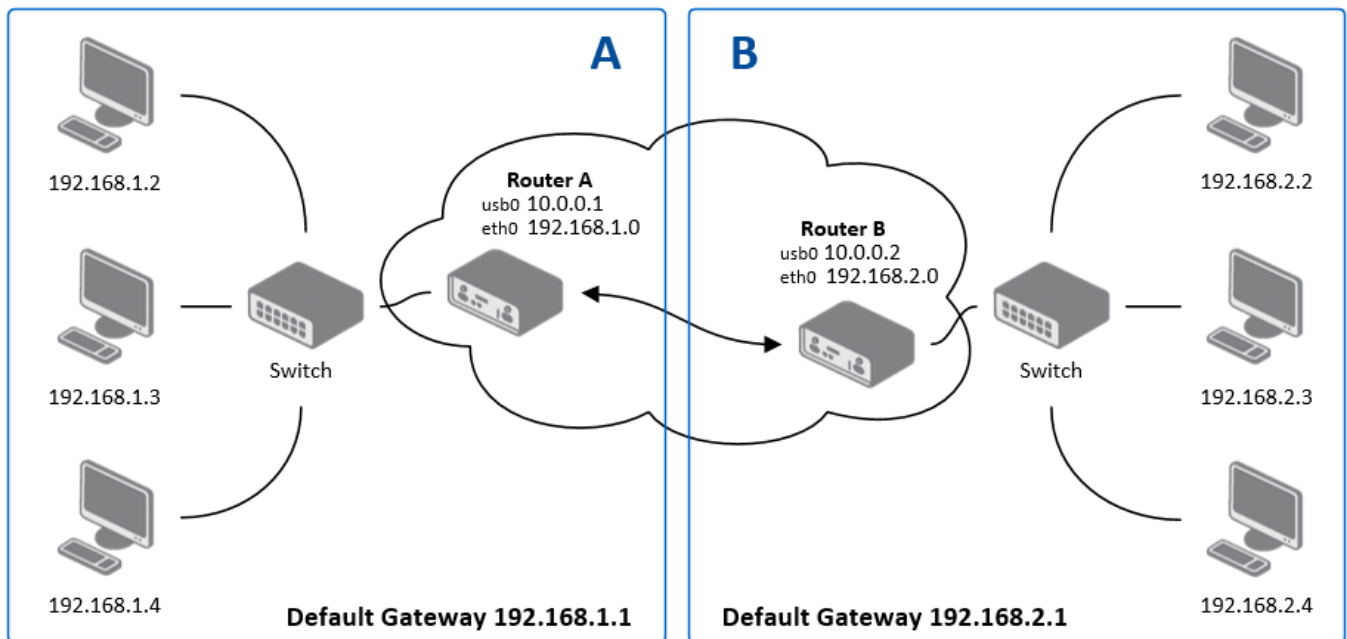

Figure 62: IPsec configuration topology example

Example configurations for Router A and Router B:

Configuration	Router A	Router B
Host IP Mode	IPv4	IPv4
1st Remote IP Address	10.0.0.2	10.0.0.1
Tunnel IP Mode	IPv4	IPv4
Remote Subnet	192.168.2.0	192.168.1.0
Remote Subnet Mask	255.255.255.0	255.255.255.0
Local Subnet	192.168.1.0	192.168.2.0
Local Subnet Mask	255.255.255.0	255.255.255.0
Authenticate Mode	pre-shared key	pre-shared key
Pre-shared Key	test	test

Table 52: Simple IPv4 IPsec tunnel configuration

### 3.13 WireGuard

WireGuard is a modern, high-performance VPN protocol known for its simplicity, strong encryption, and small attack surface. It creates secure, encrypted tunnels by encapsulating network traffic within UDP packets. Advantech routers support up to four simultaneous WireGuard tunnels, each with dual-stack (IPv4/IPv6) capabilities.

The configuration pages are located under *Configuration* → *WireGuard*, with separate tabs for each of the four possible tunnels.

1st WireGuard Tunnel Configuration

Create 1st WireGuard tunnel

Description \*

Host IP Mode IPv4 ▼

Remote IP Address \*

Remote Port \*

Local Port 51820

MTU \*  bytes 128-16384 bytes

NAT/Firewall Traversal no ▼

---

Interface IPv4 Address \*

Interface IPv4 Prefix Length \*

Interface IPv6 Address \*

Interface IPv6 Prefix Length \*

---

Install Routes yes ▼

Traffic Selector subnets ▼

Remote Subnets \*

Maximum 32 items

---

Pre-shared Key \*  Generate

Local Private Key  Generate

Local Public Key \*

Remote Public Key

---

\* can be blank

Figure 63: WireGuard tunnel configuration page

#### Info

- For dynamic routing over WireGuard, the [FRR Router App](#) can be installed. This enables the use of standard routing protocols like BGP or OSPF across the tunnel.
- For detailed setup instructions and examples, refer to the [WireGuard Tunnel Application Note](#), available on the Advantech documentation portal.

## Tunnel Configuration

The following tables describe the parameters for configuring a WireGuard tunnel.

Item	Description
<i>Create WireGuard tunnel</i>	Enables and activates the respective tunnel.
<i>Description</i>	A user-defined name for the tunnel interface.
<i>Host IP Mode</i>	Sets the IP version for communication with the remote peer ( <i>IPv4</i> or <i>IPv6</i> ).
<i>Remote IP Address</i>	The public IPv4/IPv6 address or domain name of the remote peer.
<i>Remote/Local Port</i>	The UDP ports used for sending and receiving tunnel traffic. The default is 51820.
<i>MTU</i>	The Maximum Transmission Unit for the tunnel interface. The default of 1400 bytes is recommended.
<i>NAT/Firewall Traversal</i>	When set to <i>yes</i> , sends periodic keepalive packets to maintain a connection through a NAT device or firewall.
<i>Interface IPv4/IPv6 Address</i>	The virtual IPv4 or IPv6 address for the router's end of the tunnel.
<i>Interface IPv4/IPv6 Prefix Length</i>	The subnet prefix length for the tunnel interface address.
<i>Install Routes</i>	Available options: <ul style="list-style-type: none"> <li>• <b>yes</b>: Automatically installs routes based on the <i>Traffic Selector</i> and <i>Remote Subnets</i>.</li> <li>• <b>no</b>: Disables automatic route installation, typically used when a dynamic routing protocol like BGP is managing routes.</li> </ul>
<i>Traffic Selector</i>	Defines which traffic is sent through the tunnel: <ul style="list-style-type: none"> <li>• <b>all traffic</b>: Routes all outbound traffic through the tunnel (creates a 0.0.0.0/0 or ::/0 route).</li> <li>• <b>subnets</b>: Routes only traffic destined for the networks specified in the <i>Remote Subnets</i> field.</li> </ul>
<i>Remote Subnets</i>	A list of remote IPv4 or IPv6 subnets in CIDR notation (e.g., 192.168.1.0/24) to be routed through the tunnel. Up to 32 subnets can be defined.

Table 53: WireGuard tunnel configuration options

## Cryptographic Keys

WireGuard's security is based on modern public-key cryptography.

Item	Description
<i>Local Private Key</i>	The secret private key for this router. Click <i>Generate</i> to create a new one. This key must never be shared.
<i>Local Public Key</i>	The public key derived from the local private key. This key is shared with the remote peer so it can authenticate and encrypt traffic sent to this router.
<i>Remote Public Key</i>	The public key of the remote peer. This is used to authenticate the remote peer and encrypt traffic sent to it.
<i>Pre-shared Key</i>	An optional key for an additional layer of symmetric-key encryption, providing post-quantum resistance. Click <i>Generate</i> to create a new key and share it with the remote peer.

Table 54: Cryptographic key configuration

### Configuration Example

This example details a site-to-site WireGuard tunnel between Router A and Router B. Router B acts as the "server" by listening for connections, while Router A initiates the connection.

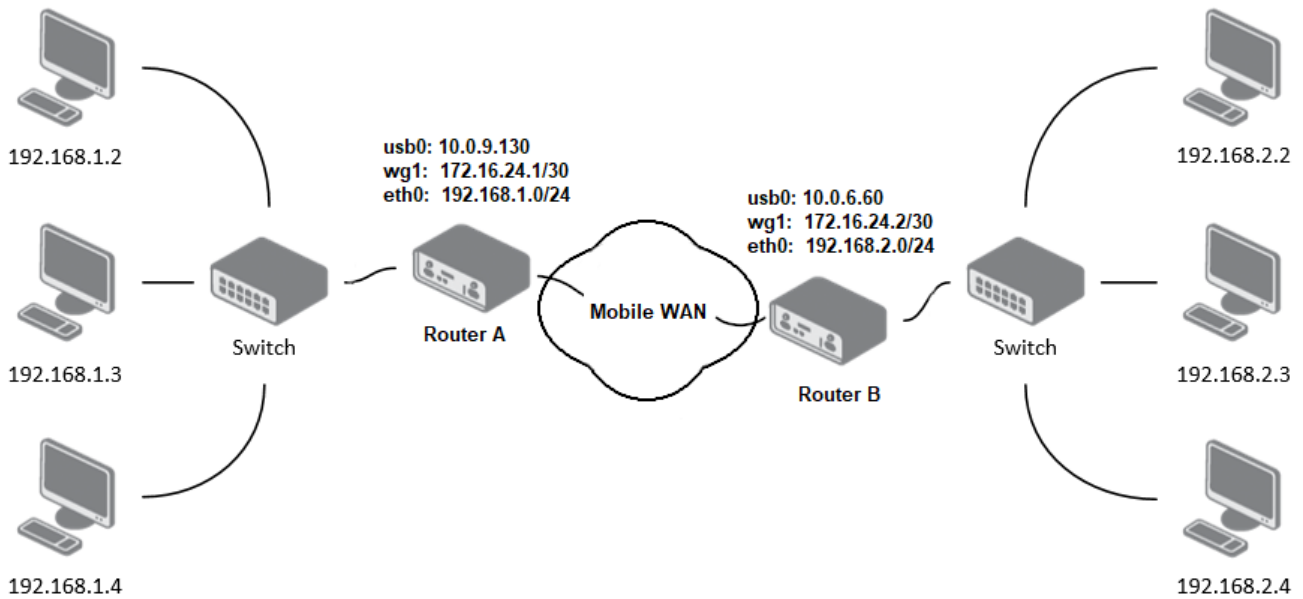

Figure 64: An example of WireGuard topology

The following table outlines the necessary configuration for each router based on the topology above.

Item	Router A Value	Router B Value
Host IP Mode	IPv4	IPv4
Remote IP Address	10.0.6.60	– (Listens on all interfaces)
Remote Port	51820	– (Listens on local port)
Local Port	51820	51820
NAT/Firewall Traversal	yes	no
Interface IPv4 Address	172.16.24.1	172.16.24.2
Interface IPv4 Prefix Length	30	30
Install Routes	yes	yes
Traffic Selector	subnets	subnets
Remote Subnets	192.168.2.0/24	192.168.1.0/24
Local Private Key	<Generated Key A>	<Generated Key B>
Local Public Key	<Public Key A>	<Public Key B>
Remote Public Key	<Public Key B>	<Public Key A>

Table 55: WireGuard IPv4 tunnel configuration example

### Verifying Connectivity

After applying the configuration, the tunnel status can be verified on the *Status* → *WireGuard* page. A successful connection is indicated by the presence of a *Latest handshake* time, which shows how long ago the last cryptographic key exchange occurred. This value will only appear after traffic has been initiated from the client side (Router A) or after the first keepalive packet has been sent.

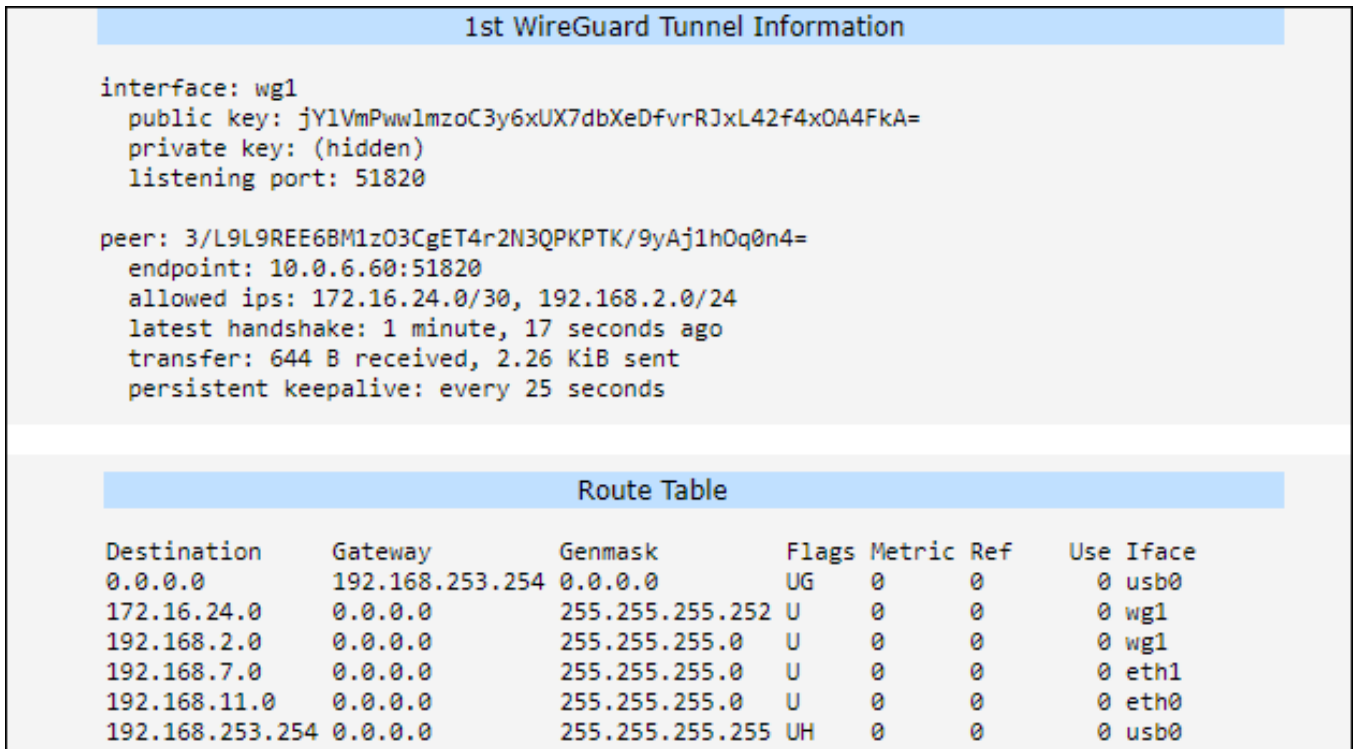

Figure 65: Router A: WireGuard status and route table

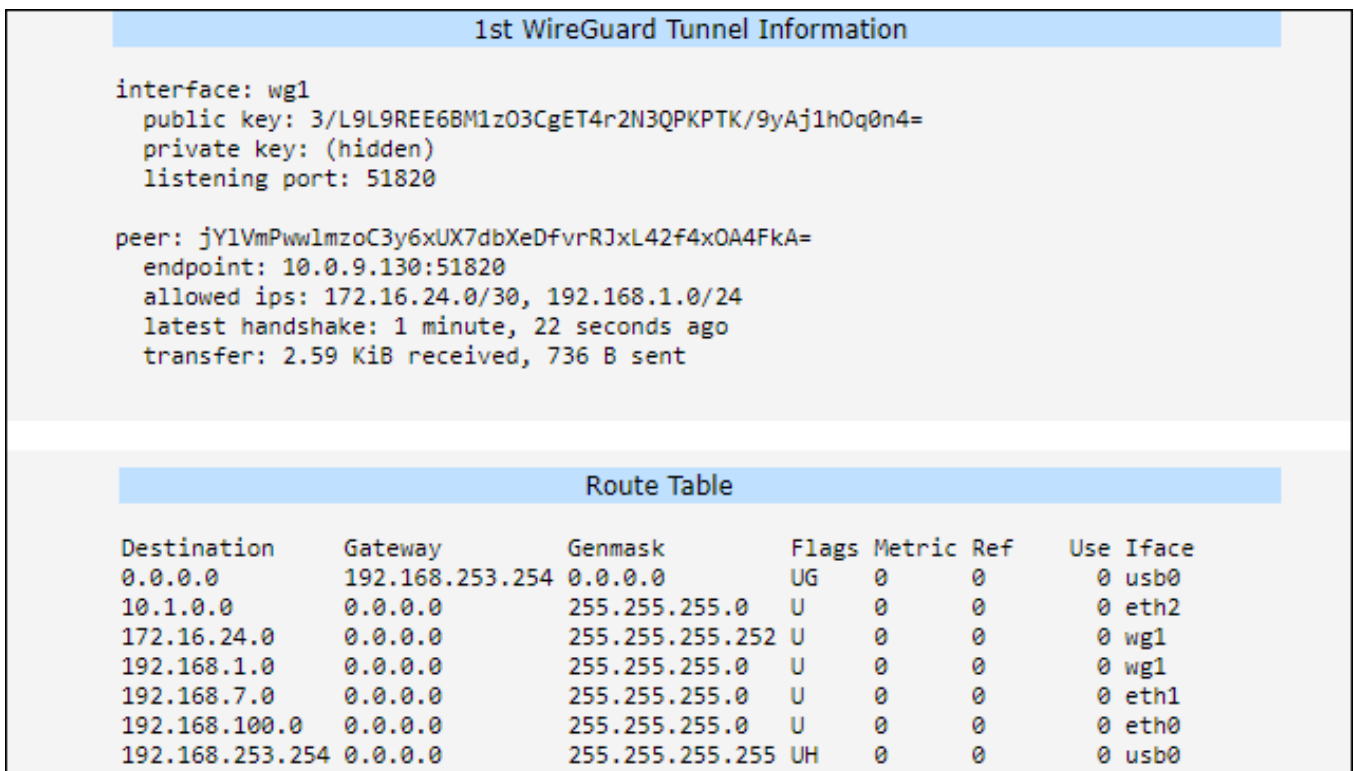

Figure 66: Router B: WireGuard status and route table

## 3.14 VXLAN

### Info

VXLAN does not provide any native encryption or authentication. When deploying VXLAN over public or untrusted networks, it is strongly recommended to route the VXLAN traffic through a secure VPN tunnel, such as *IPsec* or *WireGuard*, to ensure data confidentiality and integrity.

Virtual Extensible LAN (VXLAN) is a Layer 2 overlay scheme on a Layer 3 network. It uses a VLAN-like encapsulation to wrap Layer 2 Ethernet frames within Layer 3 UDP packets. This allows for the creation of virtualized Layer 2 subnets that can span across physical Layer 3 network boundaries. Advantech routers support up to four simultaneous VXLAN tunnels. The configuration pages for VXLAN are located under *Configuration* → *VXLAN*.

**1st VXLAN Configuration**

Create 1st VXLAN connection

Local Address

Remote Address

VNI  1-16777215

MTU \*  576-1500 bytes

Port

---

Bridged  ▼

IPv4                      IPv6

IP Address

Subnet Mask / Prefix

MAC Address \*

\* can be blank

Figure 67: VXLAN configuration page

The table below describes the parameters available for configuring each of the VXLAN interfaces.

Item	Description
<i>Create VXLAN connection</i>	Activates the selected VXLAN tunnel (1st to 4th).
<i>Local Address</i>	The local IP address of the router used as the source for the VXLAN tunnel.
<i>Remote Address</i>	The IP address of the remote tunnel peer (VTEP). For secure deployments, this should be the internal IP of an established VPN tunnel.
<i>VNI</i>	VXLAN Network Identifier (1 to 16777215). This ID must be identical on both VTEP peers.
<i>MTU</i>	Maximum Transmission Unit (576 to 1500 bytes). The recommended value is 1450 to account for the 50-byte VXLAN overhead and prevent fragmentation. This field can be left blank.
<i>Port</i>	The destination UDP port used for the outer header. The standard port is 4789.

Table 56: VXLAN configuration parameters

Item	Description
<i>Bridged</i>	Select <i>yes</i> to add the VXLAN interface to the router's local bridge, enabling seamless Layer 2 connectivity. If set to <i>no</i> , the VXLAN is considered "Routed" and has its own IP address.
<i>IP Address</i>	The IPv4 or IPv6 address assigned to the VXLAN interface. This is configured when <i>Bridged</i> is set to <i>no</i> (Routed mode).
<i>Subnet Mask / Prefix</i>	The corresponding IPv4 subnet mask or IPv6 prefix length for the assigned IP address.
<i>MAC Address</i>	A custom MAC address for the VXLAN interface. If specified, the address must be unicast and locally administered. This field is optional and can be left blank.

Table 56: VXLAN configuration parameters (continued)

## Deployment Example

In this scenario, two routers bridge their local networks over an existing *WireGuard* tunnel to ensure security. The *Bridged* option is enabled to allow Layer 2 traffic (such as broadcast or non-IP protocols) to pass transparently through the secure tunnel.

Setting	Router A (Site 1)	Router B (Site 2)
<i>Local Address</i>	10.0.0.1 (VPN IP)	10.0.0.2 (VPN IP)
<i>Remote Address</i>	10.0.0.2 (VPN IP)	10.0.0.1 (VPN IP)
<i>VNI</i>	100	100
<i>Port</i>	4789	4789
<i>Bridged</i>	<i>yes</i>	<i>yes</i>

Table 57: Example of secure VXLAN bridge over VPN

## Security Recommendations

To protect your network when using VXLAN, follow these best practices:

- **Use VPN Transport:** Never expose unencrypted VXLAN traffic directly to the internet. Always encapsulate it within *IPsec* or *WireGuard*.
- **Firewall Whitelisting:** Configure the firewall under *Configuration* → *Firewall* to allow incoming traffic on UDP port `4789` only from the trusted peer IP address.
- **MTU Adjustment:** Ensure the MTU is correctly set (e.g., `1450`) to avoid packet fragmentation issues caused by the combination of VPN and VXLAN headers.

### 3.15 GRE

Generic Routing Encapsulation (GRE) is a tunneling protocol that can encapsulate a wide variety of network layer protocols inside virtual point-to-point links over an IP network. It is a simple and effective way to create unencrypted tunnels between two separate LANs. The router supports the creation of up to four GRE tunnels.

The configuration pages are located under *Configuration* → *GRE*, with separate tabs for each of the four tunnels.

Figure 68: GRE tunnel configuration page

#### Warning

GRE is an unencrypted protocol and does not support IPv6 transport. For secure communication, it is recommended to use it in combination with IPsec.

### Tunnel Configuration

The following table describes the parameters for configuring a GRE tunnel.

Item	Description
<i>Description</i>	An optional name or description for the tunnel.
<i>Remote IP Address</i>	The public IP address of the remote tunnel endpoint.
<i>Local IP Address</i>	The public IP address of the local tunnel endpoint.
<i>Remote Subnet</i>	The IP address of the destination network behind the remote endpoint.
<i>Remote Subnet Mask</i>	The subnet mask of the remote network.
<i>Local Interface IP Address</i>	The virtual IP address of the local end of the GRE tunnel interface.
<i>Remote Interface IP Address</i>	The virtual IP address of the remote end of the GRE tunnel interface.

Table 58: GRE tunnel configuration options

Item	Description
Multicasts	Available options: <ul style="list-style-type: none"> <li><b>disabled:</b> Blocks multicast traffic from being sent through the tunnel.</li> <li><b>enabled:</b> Allows multicast traffic to be sent through the tunnel.</li> </ul>
Pre-shared Key	An optional 32-bit numerical key for basic packet validation. If a key is configured, both routers must use the same key, or packets will be dropped. This is not a cryptographic key and provides no security.

Table 58: GRE tunnel configuration options (continued)

**Warning**

GRE tunnels cannot pass through a Network Address Translation (NAT) device without a corresponding NAT traversal solution, such as a port forwarding rule for protocol 47 (GRE).

**Configuration Example**

This example shows a basic site-to-site GRE tunnel between Router A and Router B, connecting their respective LANs.

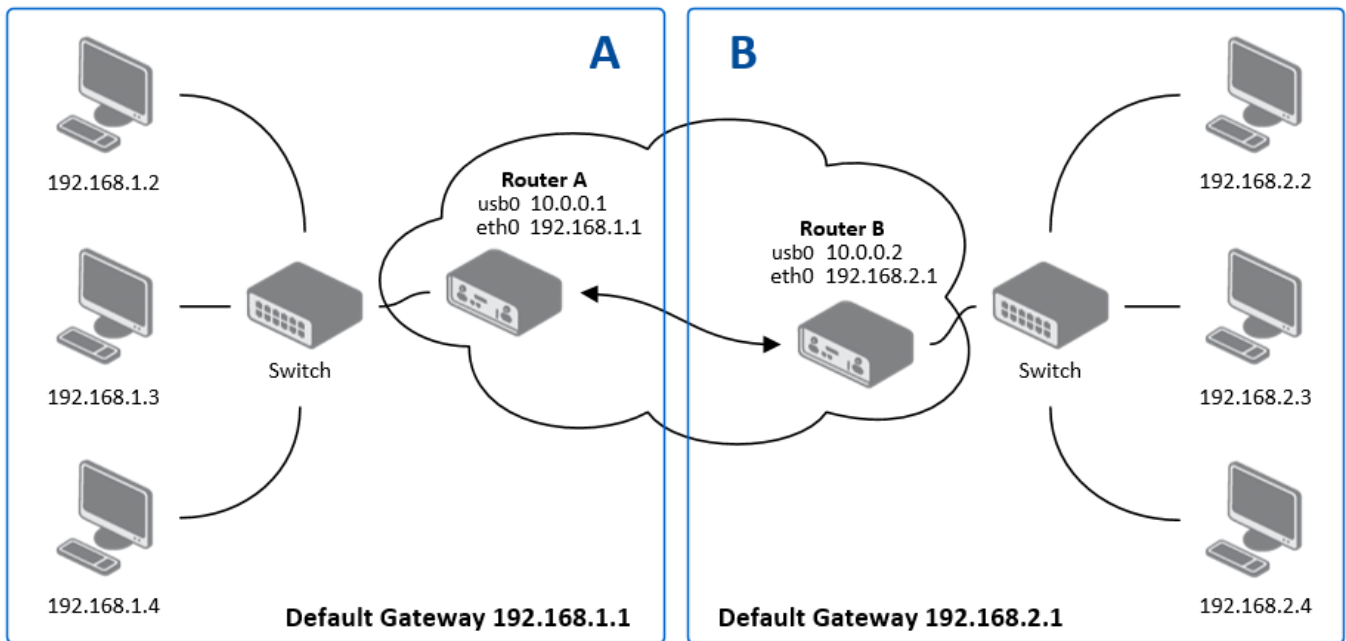

Figure 69: An example of GRE topology

The following table outlines the key parameters for this configuration.

Parameter	Router A	Router B
Remote IP Address	10.0.0.2	10.0.0.1
Remote Subnet	192.168.2.0	192.168.1.0
Remote Subnet Mask	255.255.255.0	255.255.255.0

Table 59: GRE tunnel configuration example

**Info**

For more detailed examples, please refer to the *GRE Tunnel Application Note* [8].

### 3.16 L2TP

Layer 2 Tunneling Protocol (L2TP) is a tunneling protocol used to support virtual private networks (VPNs) or as part of the delivery of services by ISPs. It does not provide any encryption itself; it relies on an encryption protocol that it passes within the tunnel to provide privacy.

The L2TP configuration page is located under *Configuration* → *L2TP*.

L2TP Tunnel Configuration

Create L2TP tunnel  
Mode L2TP client ▼  
Server IP Address   
Client Start IP Address   
Client End IP Address   
Local IP Address \*   
Remote IP Address \*   
Remote Subnet \*   
Remote Subnet Mask \*   
MRU  bytes 128-16384 bytes  
MTU  bytes 128-16384 bytes  
Username   
Password  👁  
  
\* can be blank

Figure 70: L2TP tunnel configuration page

#### Warning

 L2TP is an unencrypted protocol and does not support IPv6 transport. For secure communication, it must be combined with a security protocol like IPsec.

### Tunnel Configuration

To set up an L2TP tunnel, check the *Create L2TP tunnel* box and configure the following parameters.

Item	Description
<i>Mode</i>	Determines the router's role in the L2TP connection: <ul style="list-style-type: none"> <li>• <b>L2TP server:</b> The router acts as the L2TP Network Server (LNS), accepting connections from clients.</li> <li>• <b>L2TP client:</b> The router acts as the L2TP Access Concentrator (LAC), initiating a connection to a remote server.</li> </ul>
<i>Server IP Address</i>	(Client mode only) The IP address of the remote L2TP server.
<i>Client Start/End IP Address</i>	(Server mode only) Defines the starting and ending addresses of the IP pool from which the server will assign addresses to connecting clients.

Table 60: L2TP tunnel configuration options

Item	Description
Local IP Address	The virtual IP address of the local end of the L2TP tunnel.
Remote IP Address	The virtual IP address of the remote end of the L2TP tunnel.
Remote Subnet/Mask	The IP address and subnet mask of the network behind the remote peer, used for creating a static route.
MRU/MTU	The Maximum Receive Unit and Maximum Transmission Unit in bytes. The default value is 1400.
Username/Password	The credentials used for authenticating the L2TP session.

Table 60: L2TP tunnel configuration options (continued)

### Configuration Example

This example shows a typical client-server setup, where Router A (Server) provides access to its LAN for Router B (Client).

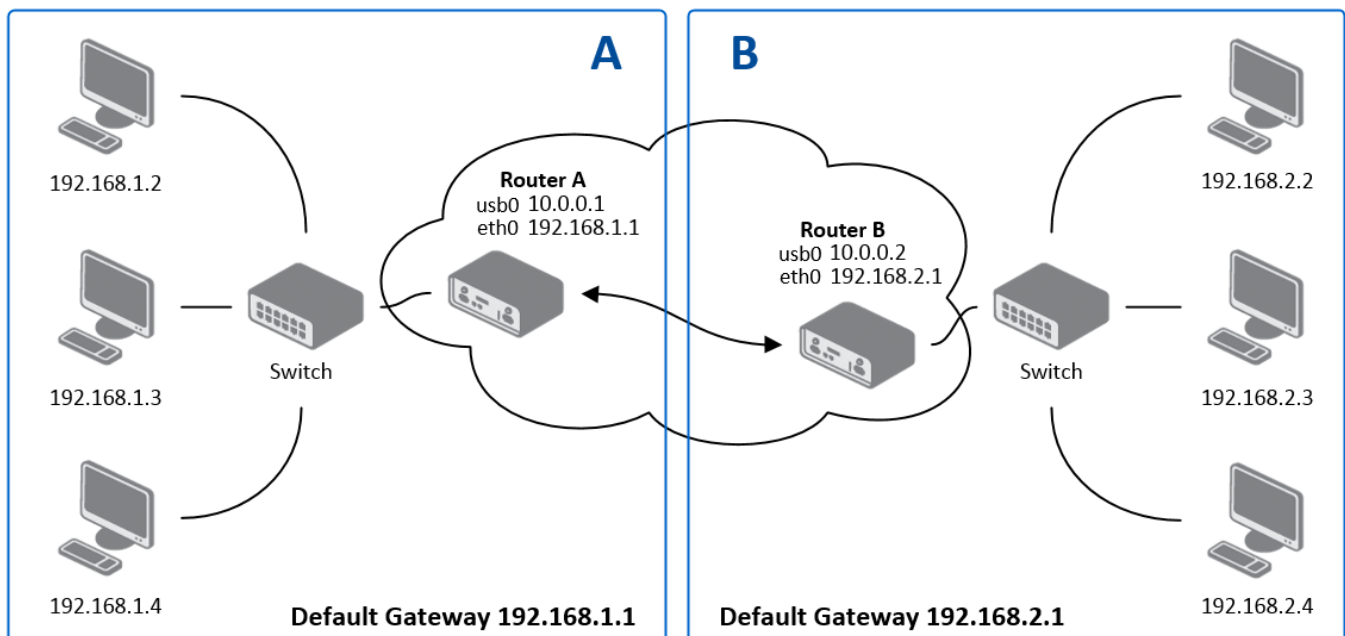

Figure 71: An example of L2TP topology

The configuration for each router is detailed below.

Parameter	Router A (Server)	Router B (Client)
Mode	L2TP Server	L2TP Client
Server IP Address	—	10.0.0.1
Client Start IP Address	192.168.2.5	—
Client End IP Address	192.168.2.254	—
Local IP Address	192.168.1.1	—
Remote Subnet	192.168.2.0	192.168.1.0
Remote Subnet Mask	255.255.255.0	255.255.255.0
Username	username	username
Password	password	password

Table 61: L2TP tunnel configuration example

### 3.17 PPTP

Point-to-Point Tunneling Protocol (PPTP) is a tunneling protocol used to create simple, password-protected connections between two LANs. To configure a tunnel, navigate to the *Configuration* → *PPTP* page.

PPTP Tunnel Configuration

Create PPTP tunnel  
**Mode** PPTP client ▼  
**Server IP Address**   
**Local IP Address**   
**Remote IP Address**   
**Remote Subnet \***   
**Remote Subnet Mask \***   
**MRU**  bytes 128-16384 bytes  
**MTU**  bytes 128-16384 bytes  
**Username**   
**Password**  👁

\* can be blank

Figure 72: PPTP tunnel configuration page

#### Warning

PPTP is an outdated and insecure protocol with known vulnerabilities. It does not support IPv6. It is strongly recommended to use a modern, secure VPN protocol such as WireGuard or OpenVPN instead.

### Tunnel Configuration

To set up a PPTP tunnel, check the *Create PPTP tunnel* box and configure the following parameters.

Item	Description
<i>Mode</i>	Determines the router's role in the PPTP connection: <ul style="list-style-type: none"> <li>• <b>PPTP server:</b> The router acts as the server, accepting connections from remote clients.</li> <li>• <b>PPTP client:</b> The router acts as the client, initiating a connection to a remote server.</li> </ul>
<i>Server IP Address</i>	(Client mode only) The IP address of the remote PPTP server.
<i>Local IP Address</i>	The virtual IP address for the local end of the tunnel.
<i>Remote IP Address</i>	The virtual IP address for the remote end of the tunnel.
<i>Remote Subnet/Mask</i>	The IP address and subnet mask of the network behind the remote peer.

Table 62: PPTP tunnel configuration options

Item	Description
MRU/MTU	The Maximum Receive Unit and Maximum Transmission Unit in bytes. The default value is 1460 to avoid packet fragmentation.
Username/Password	The credentials for authenticating the PPTP session.

Table 62: PPTP tunnel configuration options (continued)

**Info**



The router firmware also supports PPTP passthrough, which allows PPTP client devices on the LAN to establish tunnels through the router to an external server.

**Configuration Example**

This example shows a standard client-server setup where Router A (Server) accepts a connection from Router B (Client).

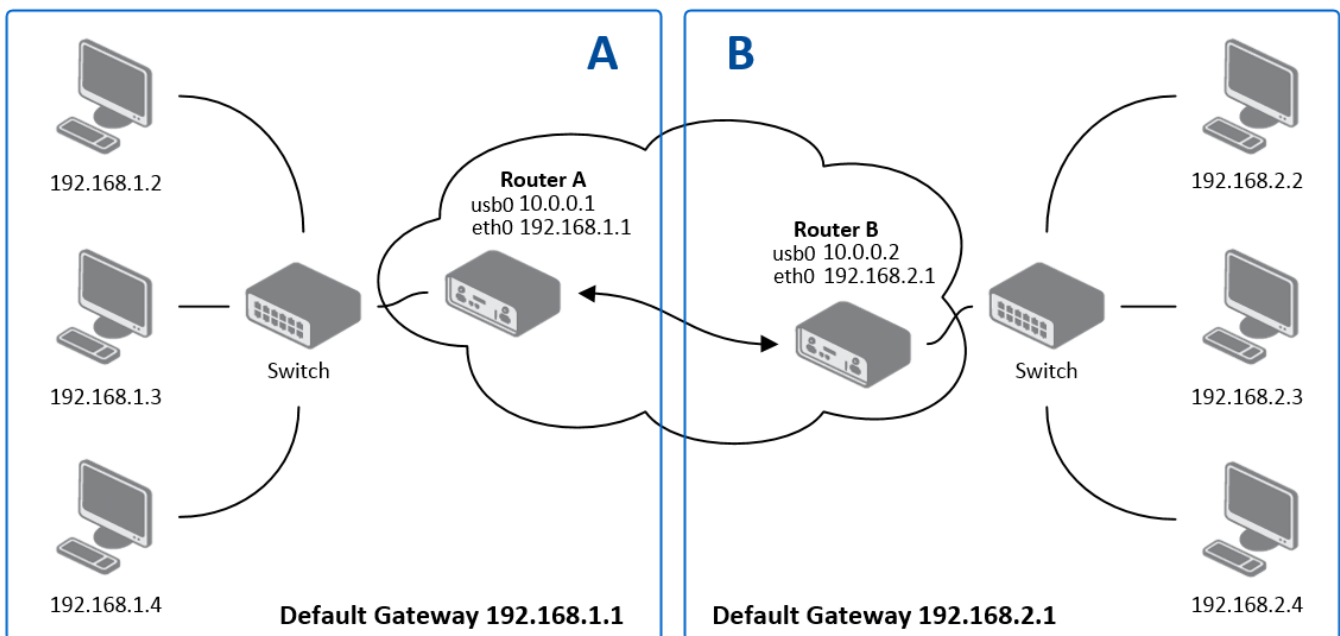

Figure 73: An example of PPTP topology

The configuration for each router is outlined below.

Parameter	Router A (Server)	Router B (Client)
Mode	PPTP Server	PPTP Client
Server IP Address	—	10.0.0.1
Local IP Address	192.168.1.1	—
Remote IP Address	192.168.2.1	—
Remote Subnet	192.168.2.0	192.168.1.0
Remote Subnet Mask	255.255.255.0	255.255.255.0
Username	username	username
Password	password	password

Table 63: PPTP tunnel configuration example

## 3.18 Services

### 3.18.1 Dynamic DNS

The Dynamic DNS client allows you to access the router using a fixed, memorable hostname, even if the router's IP address changes. The client monitors the router's public IP address and automatically updates the DNS record on a Dynamic DNS server whenever a change is detected. The service includes support for standard DDNS (RFC 2136) and secure updates via HTTPS. To configure the service, navigate to *Services* → *Dynamic DNS*.

#### Warning

For the Dynamic DNS service to function correctly, the router's SIM card must be assigned a public IP address by the mobile provider.

The table below describes the settings available on the *Dynamic DNS Configuration* page.

Setting	Description
Hostname	Your fully qualified domain name registered with a Dynamic DNS provider (e.g., <i>myrouter.example.com</i> ).
IP Mode	Select the IP protocol version for the Dynamic DNS updates: <ul style="list-style-type: none"> <li>• <b>IPv4</b> – Use only the IPv4 address (default).</li> <li>• <b>IPv6</b> – Use only the IPv6 address.</li> <li>• <b>IPv4/IPv6</b> – Use both IPv4 and IPv6 addresses (dual-stack).</li> </ul>
Service	Select the protocol used for the update. Options are <b>DynDNS (HTTP API)</b> for standard web-based providers or <b>DDNS (RFC 2136)</b> for direct updates to standard DNS servers.
Server	The update server address of your Dynamic DNS provider. If left blank, the default value <code>members.dyndns.org</code> is used. Several free services are available, including: <a href="http://freedns.afraid.org">freedns.afraid.org</a> , <a href="http://www.duckdns.org">www.duckdns.org</a> , and <a href="http://www.noip.com">www.noip.com</a> . Secure HTTPS URLs are supported. Active only when <i>Service</i> is set to <i>DynDNS (HTTP API)</i> .
Username	The username for your Dynamic DNS service account. Active only when <i>Service</i> is set to <i>DynDNS (HTTP API)</i> .
Password	The password for your Dynamic DNS service account. Active only when <i>Service</i> is set to <i>DynDNS (HTTP API)</i> .
Skip Certificate Verification	Check this box to bypass SSL/TLS certificate validation when connecting to an HTTPS server. Active only when <i>Service</i> is set to <i>DynDNS (HTTP API)</i> .
CA Certificate	The Certificate Authority (CA) certificate used to verify the server's identity during HTTPS updates. Active only when <i>Service</i> is set to <i>DynDNS (HTTP API)</i> .
TTL	Time to Live for the DNS record, specifying how long the record is cached by DNS resolvers. The default value is <code>60</code> seconds, with an allowed range from <code>5</code> to <code>86400</code> seconds. Active only when <i>Service</i> is set to <i>DDNS (RFC 2136)</i> .
TSIG Key	The Transaction Signature (TSIG) key used to authenticate updates. Active only when <i>Service</i> is set to <i>DDNS (RFC 2136)</i> .

Table 64: Dynamic DNS configuration settings

## Configuration Example

The example below demonstrates how to configure the router to securely update a dual-stack (IPv4 and IPv6) DNS record. In this scenario, the router updates the hostname *router.example.com* using a custom provider's secure HTTPS API. To ensure maximum security, SSL/TLS certificate verification is enforced (*Skip Certificate Verification* is unchecked). The content of a specific *CA Certificate* is pasted into the corresponding text area (or imported using the *Load From File* button) to authenticate the server.

Setting	Value
Hostname	router.example.com
IP Mode	IPv4/IPv6
Service	DynDNS (HTTP API)
Server	https://ddns.example.com
Username	admin_user
Password	<your_secure_password>
Skip Certificate Verification	unchecked
CA Certificate	<pasted PEM certificate content>

Table 65: Example of secure Dynamic DNS configuration

### Info

To access the router's web interface from the internet, you must also enable Remote Access. For details, see Chapter 3.10 NAT.

### 3.18.2 FTP

#### Warning

FTP is an unencrypted protocol.

FTP protocol (File Transfer Protocol) can be used to transfer files between the router and another device on the computer network. Configuration form of TP server can be done in *FTP* configuration page under *Services* menu item.

Item	Description
<i>Enable FTP service</i>	Enabling of FTP server.
<i>Maximum Sessions</i>	Indicates how many concurrent connections shall the FTP server accept. Once the maximum is reached, additional connections will be rejected until some of the existing connections are terminated. The range is from 1 to 500.
<i>Session Timeout</i>	Is used to close inactive sessions. The server will terminate a FTP session after it has not been used for the given amount of seconds. The range is from 60 to 7200.

Table 66: FTP configuration items description

FTP Configuration	
<input type="checkbox"/> Enable FTP service	
Maximum Sessions	<input type="text" value="50"/> 1-500
Session Timeout	<input type="text" value="600"/> sec 60-7200 sec
<input type="button" value="Apply"/>	

Figure 74: Configuration of FTP server

### 3.18.3 HTTP

**Warning**



Make sure your certificate matches the *Security Level*. Increasing *Security Level* without generating a new certificate may lead to inability to connect to Web GUI.

This page allows you to manage both HTTP and the secure HTTPS protocols. For maximum security, it is strongly recommended to use HTTPS, as it encrypts all communication between your browser and the router. The router allows you to toggle these services using the *Enable HTTP service* and *Enable HTTPS service* checkboxes. Note that even if the HTTP service is unchecked (disabled), the router will still listen on the standard HTTP port for the sole purpose of automatically redirecting any incoming requests to the secure HTTPS port.

**HTTP Configuration**

Enable HTTP service

Enable HTTPS service

---

Security Level ▼ 1 - Low

Minimum TLS Version ▼ TLS 1.2

Session Timeout 600 sec 60-100000 sec

---

Login Banner

---

Keep the current certificate  
 Generate a new certificate  
 Upload a new certificate

Certificate Choose File No file chosen

Private Key Choose File No file chosen

---

Apply

Figure 75: Web server configuration page

Item	Description
<i>Enable HTTP service</i>	Enables unencrypted access to the web interface. Not recommended.
<i>Enable HTTPS service</i>	Enables secure, encrypted access to the web interface. This is the default and recommended setting.

Table 67: Web server configuration items description

Item	Description
<i>Security Level</i> <sup>1</sup>	<p>Sets the minimum cryptographic strength for the connection by controlling which TLS versions and cipher suites are permitted. Higher levels disable older, less secure algorithms.</p> <ul style="list-style-type: none"> <li>• <b>0 - Weak:</b> Allows all cryptographic suites, including insecure legacy algorithms. <b>This level is not recommended and should only be used for compatibility with outdated systems.</b></li> <li>• <b>1 - Low:</b> [Default] Provides a baseline of 80-bit security.</li> <li>• <b>2 - Medium:</b> Enforces a minimum of 112-bit security.</li> <li>• <b>3 - High:</b> Enforces a minimum of 128-bit security (requires AES-128 or stronger).</li> <li>• <b>4 - Very High:</b> Enforces a minimum of 192-bit security (requires AES-192 or stronger).</li> </ul>
<i>Minimum TLS Version</i>	<p>Defines the minimum version of the TLS protocol that the router's web server will accept for HTTPS connections. For maximum security, it is recommended to select the highest version compatible with your clients. The available options range from TLS 1.0 to TLS 1.3. Please note that the insecure TLS 1.0 and 1.1 versions are only available for selection if the <i>Security Level</i> is set to 0.</p>
<i>Session Timeout</i>	<p>Defines the period of inactivity (in minutes) after which a user is automatically logged out.</p>
<i>Login Banner</i>	<p>Displays custom text on the login page, directly above the username and password fields.</p>
<i>Keep the current certificate</i>	<p>Makes no changes to the certificate currently stored on the router.</p>
<i>Generate a new certificate</i>	<p>Generates a new self-signed certificate for the router, corresponding to the selected <i>Security Level</i>. Make sure your certificate matches the <i>Security Level</i>.</p>
<i>Upload a new certificate</i>	<p>Allows you to upload a custom certificate, such as one signed by a trusted Certificate Authority (CA).</p>
<i>Certificate</i>	<p>Use the file browser to select the PEM-formatted certificate file to upload. The file can contain a single certificate or a complete certificate chain.</p>
<i>Private Key</i>	<p>Use the file browser to select the private key file corresponding to the certificate being uploaded.</p>

Table 67: Web server configuration items description (continued)

<sup>1</sup>For detailed explanation see the *Security Guidelines* [15], specifically the chapter on *Cryptographic algorithms*.

### 3.18.4 LLDP

#### Info

Information about discovered neighbors can be viewed on the *Status* → *Network* page, under the *LLDP Neighbors* section.

The Link Layer Discovery Protocol (LLDP) is a vendor-neutral, Layer 2 network protocol used by devices to advertise their identity, capabilities, and neighbors on a local area network. Enabling LLDP on the router facilitates easier network mapping, topology discovery, and troubleshooting in multi-vendor environments. To configure this feature, navigate to *Configuration* → *Services* → *LLDP*.

Figure 76: LLDP configuration page

The table below describes the settings available on the LLDP configuration page. After making any changes, click the *Apply* button to save and activate the new configuration.

Item	Description
<i>Enable LLDP</i>	Activates the Link Layer Discovery Protocol globally on the router.
Mode	Defines the communication mode for all available Ethernet interfaces. For devices equipped with a switch, this includes individual switch ports. The available options for each interface are: <ul style="list-style-type: none"> <li>• <b>TX/RX</b> – The port both transmits its own LLDP advertisements and receives LLDP packets from neighboring devices.</li> <li>• <b>RX</b> – The port only receives LLDP packets but does not transmit its own.</li> <li>• <b>off</b> – LLDP communication is completely disabled on this specific port.</li> </ul>
<i>Transmit Interval</i>	Specifies the frequency, in seconds, at which LLDP advertisement packets are broadcasted to neighbors. The default value is typically 5 seconds, and the permitted range is from 5 to 86400 seconds.

Table 68: LLDP configuration parameters

### 3.18.5 NTP

The NTP (Network Time Protocol) configuration page allows you to configure the router's NTP client and/or server functions. To open the *NTP* configuration page, click *NTP* in the *Configuration* section of the main menu.

#### Info

- Some configuration options described may not be available on all router models.
- Upon initial activation, the NTP service may require up to 15 minutes to stabilize due to hardware clock adjustments. During this period, Syslog may report `TIME_ERROR: Clock Unsynchronized`. This is normal and will resolve when synchronization is complete.

#### Warning

Operating the router as an NTP server while its own clock is not synchronized to a reliable external time source (e.g., remote NTP server, cellular network, or GNSS) is strongly discouraged. This may result in incorrect time propagation to other devices relying on this router.

NTP Configuration

Enable local NTP server

---

Synchronize clock with cellular network

Synchronize clock with remote NTP server

Primary NTP Server

Secondary NTP Server \*

Tertiary NTP Server \*

Maximal Polling Interval  ▼

Enable fast initial synchronization

---

Timezone  ▼

Daylight Saving Time  ▼

---

\* can be blank

Figure 77: NTP configuration page

**Info****Time-Synchronization Accuracy**

The accuracy of the router's clock depends on the chosen synchronization source:

- **Remote NTP Server:** This is typically the most accurate method. External NTP servers are usually synchronized to atomic clocks and maintained for high-precision timekeeping.
  - Typical accuracy: Within several milliseconds.
- **Cellular Network (NITZ):** Synchronization via the cellular network (a feature known as NITZ) can vary depending on the operator's infrastructure and is generally less precise than dedicated NTP servers.
  - Typical accuracy: Up to several seconds.
- **GNSS:** While satellite-based time is reliable for general clock correction, its precision for NTP is limited by receiver hardware, atmospheric conditions, and internal processing delays. Therefore, it is not recommended for applications requiring high-precision timekeeping.
  - Typical accuracy: Around one second.

For applications requiring precise time synchronization, always prefer remote NTP servers over GNSS.

Item	Description
<i>Enable local NTP server</i>	Enables the built-in NTP server, allowing devices on the local network to synchronize their clocks with the router. The time accuracy depends on how the router itself is synchronized.
<i>Synchronize clock with cellular network</i>	Enables automatic synchronization of the router's system clock with the time provided by the connected cellular network. This functionality depends on support from the mobile operator.
<i>Synchronize clock with GNSS</i>	Enables automatic synchronization of the router's system clock using the precise time signal from a connected GNSS module. This option is only available if a compatible module is installed and receiving a valid satellite signal.
<i>Synchronize clock with remote NTP server</i>	Enables querying of specified remote NTP servers (up to three, in order of preference) for time synchronization.
<i>Primary NTP Server</i>	IP address or domain name of the primary external NTP server. Used if 'Synchronize clock with remote NTP server' is enabled.
<i>Secondary NTP Server</i>	IP address or domain name of the secondary NTP server (optional). Used if the primary server is unavailable.
<i>Tertiary NTP Server</i>	IP address or domain name of the tertiary NTP server (optional). Used if both primary and secondary are unavailable.
<i>Maximal Polling Interval</i>	Sets the maximum interval for synchronization polls (usually in seconds/minutes). Longer intervals reduce network load but may reduce time accuracy.
<i>Enable fast initial synchronization</i>	If enabled, the router performs a rapid clock update when a significant difference is detected between the system time and the received time, reducing convergence time.
<i>Timezone</i>	Defines the router's local timezone for time display and daylight saving adjustment.
<i>Daylight Saving Time</i>	Enables or disables automatic daylight saving adjustment for the set timezone.

Table 69: NTP configuration items description

### 3.18.6 SMTP

The router includes a Simple Mail Transfer Protocol (SMTP) client, which can be configured to send emails for notifications or from scripts. To configure the client, navigate to *Services* → *SMTP*.

#### Info

- The settings on this page must match the requirements of your email provider's SMTP server.
- Note that some mobile service providers may block standard SMTP ports, potentially restricting you to using the provider's own SMTP server.

SMTP Configuration

SMTP Server Address	<input type="text" value="smtp.domain.com"/>
SMTP Port	<input type="text" value="465"/>
Secure Method	<input style="border-bottom: 1px solid #ccc;" type="text" value="SSL/TLS"/> ▼
Username	<input type="text" value="username"/>
Password	<input type="password" value="....."/>
Own Email Address	<input type="text" value="name@domain.com"/>
<input type="button" value="Apply"/>	

Figure 78: SMTP client configuration example

Item	Description
<i>SMTP Server Address</i>	The IP address or domain name of your outgoing mail server.
<i>SMTP Port</i>	The port number the SMTP server uses. Common ports include 25, 465 (SSL/TLS), and 587 (STARTTLS).
<i>Secure Method</i>	The encryption method required by the server. The options are <i>none</i> , <i>SSL/TLS</i> , or <i>STARTTLS</i> .
<i>Username</i>	The username for your email account.
<i>Password</i>	The password for your email account.
<i>Own Email Address</i>	The sender's email address that will appear on outgoing emails (e.g., my-router@mydomain.com).

Table 70: SMTP client configuration settings

### Sending Emails

Once the SMTP client is configured, you can trigger emails in two ways:

- **From a script:** Use the `email` command within a startup or custom script. Scripts are managed on the *Configuration* → *Scripts* page.
- **From the command line:** Connect to the router via SSH and use the `email` command directly.

For detailed syntax and examples of the `email` command, refer to the [Command Line Interface Application Note \[1\]](#).

### 3.18.7 SMS

Open the *SMS Configuration* page, click *SMS* in the *Configuration* section of the main menu. The router can automatically send SMS messages to a cell phone or SMS message server when certain events occur. The form allows you to select which events generate an SMS message.

Item	Description
Send SMS on power up	Activates/deactivates the sending of an SMS message automatically on power up.
Send SMS on connect to mobile network	Activates/deactivates the sending of an SMS message automatically when the router is connected to a mobile network.
Send SMS on disconnect to mobile network	Activates/deactivates the sending of an SMS message automatically when the router is disconnection from a mobile network.
Send SMS when datalimit exceeded	Activates/deactivates the sending of an SMS message automatically when the data limit exceeded.
Send SMS when binary input on I/O port (BIN0) is active	Automatic sending SMS message after binary input on I/O port (BIN0) is active. Text of message is intended parameter BIN0.
Add timestamp to SMS	Activates/deactivates the adding a time stamp to the SMS messages. This time stamp has a fixed format YYYY-MM-DD hh:mm:ss.
Phone Number 1	Specifies the phone number to which the router sends the generated SMS.
Phone Number 2	Specifies the phone number to which the router sends the generated SMS.
Phone Number 3	Specifies the phone number to which the router sends the generated SMS.
Unit ID	The name of the router. The router sends the name in the SMS.
BIN0 – SMS	Text of SMS message send when binary input is activated.

Table 71: SMS configuration

### Remote Control via SMS

After you enter a phone number in the *Phone Number 1* field, the router allows you to configure the control of the device using an SMS message. You can configure up to three numbers for incoming SMS messages. To enable the function, mark the *Enable remote control via SMS* check box. The default setting of the remote control function is active.

Item	Description
Phone Number 1	Specifies the first phone number allowed to access the router using an SMS.
Phone Number 2	Specifies the second phone number allowed to access the router using an SMS.
Phone Number 3	Specifies the third phone number allowed to access the router using an SMS.

Table 72: Control via SMS

#### Warning

If you enter one or more phone numbers, then you can control the router using SMS messages sent only from the specified phone numbers.  
If you enter the wild card character \*, then you can control the router using SMS messages sent from any phone number.

Most of the control SMS messages do not change the router configuration. For example, if the router is changed to the off line mode using an SMS message, the router remains in this mode, but it will return back

to the on-line mode after reboot. The only exception is *set profile* command that changes the configuration permanently, see the table below.

To control the router using an SMS, send only message text containing the control command. You can send control SMS messages in the following form:

SMS	Description
go online sim 1	The router changes to SIM1
go online sim 2	The router changes to SIM2
go online	Changes the router to the online mode
go offline	Changes the router to the off line mode
set out0=0	Sets the binary output to 0
set out0=1	Sets the binary output to 1
set profile std	Sets the standard profile. This change is permanent.
set profile alt1	Sets the alternative profile 1. This change is permanent.
set profile alt2	Sets the alternative profile 2. This change is permanent.
set profile alt3	Sets the alternative profile 3. This change is permanent.
reboot	The router reboots
get ip	The router responds with the IP address of the SIM card

Table 73: Control SMS types

#### Warning

**Note:** Every received control SMS is processed and then **deleted** from the router! This may cause a confusion when you want to use AT-SMS protocol for reading received SMS (see section below).

#### Info

**Advanced SMS control:** If there is unknown command in received SMS and remote control via SMS is enabled, the script located in `"/var/scripts/sms"` is run before the SMS is deleted. It is possible to define your own additional SMS commands using this script. Maximum of 7 words can be used in such SMS. Since the script file is located in RAM of the router, it is possible to add creation of such file to Startup Script. See example in *Command Line Interface Application Note [1]*.

## AT-SMS Protocol

#### Info

AT-SMS protocol is a private set of AT commands supported by the routers. It can be used to access the cellular module in the router directly via commonly used AT commands, work with short messages (send SMS) and cellular module state information and settings.

Choosing *Enable AT-SMS protocol on expansion port* and *Baudrate* makes it possible to use AT-SMS protocol on the serial interface.

Item	Description
Baudrate	Communication speed on the expansion port

Table 74: Send SMS on the serial port 2

Setting the parameters in the *Enable AT-SMS protocol over TCP* frame, you can enable the router to use AT-SMS protocol on a TCP port. This function requires you to specify a TCP port number.

Item	Description
TCP Port	TCP port on which will be allowed to send/receive SMS messages.

Table 75: Sending and receiving SMS on a specified TCP port

If you establish a connection to the router through a serial interface or interface using the TCP protocol, then you can use AT commands to manage SMS messages.

Only the commands supported by the routers are listed in the following table. For other AT commands the OK response is always sent. There is no support for treatment of complex AT commands, so in such a case the router sends ERROR response.

AT Command	Description
AT+CGMI	Returns the manufacturer specific identity
AT+CGMM	Returns the manufacturer specific model identity
AT+CGMR	Returns the manufacturer specific model revision identity
AT+CGPADDR	Displays the IP address of the Mobile WAN interface
AT+CGSN	Returns the product serial number
AT+CIMI	Returns the International Mobile Subscriber Identity number (IMSI)
AT+CMGD	Deletes a message from the location
AT+CMGF	Sets the presentation format of short messages
AT+CMGL	Lists messages of a certain status from a message storage area
AT+CMGR	Reads a message from a message storage area
AT+CMGS	Sends a short message from the device to entered tel. number
AT+CMGW	Writes a short message to SIM storage
AT+CMSS	Sends a message from SIM storage location value
AT+CNUM	Returns the phone number, if available (stored on SIM card)
AT+COPS?	Identifies the available mobile networks
AT+CPIN	Is used to find out the SIM card state and enter a PIN code
AT+CPMS	Selects SMS memory storage types, to be used for short message operations
AT+CREG	Displays network registration status
AT+CSCA	Sets the short message service centre (SMSC) number
AT+CSCS	Selects the character set
AT+CSQ	Returns the signal strength of the registered network
AT+GMI	Returns the manufacturer specific identity
AT+GMM	Returns the manufacturer specific model identity
AT+GMR	Returns the manufacturer specific model revision identity
AT+GSN	Returns the product serial number
ATE	Determines whether or not the device echoes characters
ATI	Transmits the manufacturer specific information about the device

Table 76: AT commands list

#### Info

A detailed description and examples of these AT commands can be found in the application note *AT Commands (AT-SMS)* [12].

## Sending SMS from Router

There are more ways how to send your own SMS from the router:

- Using AT-SMS protocol described above – if you establish a connection to the router through a serial interface or interface using the TCP protocol, then you can use AT commands to manage SMS messages. See application note *AT Commands (AT-SMS)* [12].
- Using HTTP POST method for a remote execution, calling CGI scripts in the router. See *Command Line Interface* Application Note [1] for more details and example.
- From Web interface of the router, in *Administration* section, *Send SMS* item, see 5.6 Chapter.
- Using `gsmsms` command e.g. in terminal when connected to the router via SSH, see *Command Line Interface* Application Note [1].

## Examples of SMS Configuration

### Example 1

#### Sending SMS Configuration

After powering up the router, the phone with the number entered in the dialog receives an SMS in the following form:

Router (Unit ID) has been powered up. Signal strength –xx dBm.

After connecting to mobile network, the phone with the number entered in the dialog receives an SMS in the following form:

Router (Unit ID) has established connection to mobile network. IP address xxx.xxx.xxx.xxx

After disconnecting from the mobile network, the phone with the number entered in the dialog receives an SMS in the following form:

Router (Unit ID) has lost connection to mobile network. IP address xxx.xxx.xxx.xxx

SMS Configuration	
<input checked="" type="checkbox"/>	Send SMS on power up
<input checked="" type="checkbox"/>	Send SMS on connect to mobile network
<input checked="" type="checkbox"/>	Send SMS on disconnect from mobile network
<input checked="" type="checkbox"/>	Send SMS when datalimit is exceeded
<input checked="" type="checkbox"/>	Send SMS when binary input on I/O port (BIN0) is active
<input checked="" type="checkbox"/>	Add timestamp to SMS
Phone Number 1	<input type="text" value="723123456"/>
Phone Number 2	<input type="text" value="756858635"/>
Phone Number 3	<input type="text" value="603854758"/>
Unit ID *	<input type="text" value="Router"/>
BIN0 - SMS *	<input type="text" value="BIN0"/>
<input checked="" type="checkbox"/>	Enable remote control via SMS
Phone Number 1	<input type="text"/>
Phone Number 2	<input type="text"/>
Phone Number 3	<input type="text"/>
<input type="checkbox"/>	Enable AT-SMS protocol on expansion port
Baudrate	<input type="text" value="9600"/>
<input type="checkbox"/>	Enable AT-SMS protocol over TCP
TCP Port	<input type="text"/>
* can be blank	
<input type="button" value="Apply"/>	

Figure 79: SMS Configuration for example 1

**Example 2**

## Sending SMS via Serial Interface

SMS Configuration	
<input type="checkbox"/>	Send SMS on power up
<input type="checkbox"/>	Send SMS on connect to mobile network
<input type="checkbox"/>	Send SMS on disconnect from mobile network
<input type="checkbox"/>	Send SMS when datalimit is exceeded
<input type="checkbox"/>	Send SMS when binary input on I/O port (BIN0) is active
<input type="checkbox"/>	Add timestamp to SMS
Phone Number 1	<input type="text"/>
Phone Number 2	<input type="text"/>
Phone Number 3	<input type="text"/>
Unit ID *	<input type="text"/>
BIN0 - SMS *	<input type="text"/>
<input type="checkbox"/>	Enable remote control via SMS
Phone Number 1	<input type="text"/>
Phone Number 2	<input type="text"/>
Phone Number 3	<input type="text"/>
<input checked="" type="checkbox"/>	Enable AT-SMS protocol on expansion port
Baudrate	<input type="text" value="9600"/>
<input type="checkbox"/>	Enable AT-SMS protocol over TCP
TCP Port	<input type="text"/>
* can be blank	
<input type="button" value="Apply"/>	

Figure 80: SMS Configuration for example 2

**Example 3**

Control the Router Sending SMS from any Phone Number

SMS Configuration	
<input type="checkbox"/>	Send SMS on power up
<input type="checkbox"/>	Send SMS on connect to mobile network
<input type="checkbox"/>	Send SMS on disconnect from mobile network
<input type="checkbox"/>	Send SMS when datalimit is exceeded
<input type="checkbox"/>	Send SMS when binary input on I/O port (BIN0) is active
<input type="checkbox"/>	Add timestamp to SMS
Phone Number 1	<input type="text"/>
Phone Number 2	<input type="text"/>
Phone Number 3	<input type="text"/>
Unit ID *	<input type="text"/>
BIN0 - SMS *	<input type="text"/>
<input checked="" type="checkbox"/>	Enable remote control via SMS
Phone Number 1	<input type="text" value="*"/>
Phone Number 2	<input type="text"/>
Phone Number 3	<input type="text"/>
<input type="checkbox"/>	Enable AT-SMS protocol on expansion port
Baudrate	<input type="text" value="9600"/>
<input type="checkbox"/>	Enable AT-SMS protocol over TCP
TCP Port	<input type="text"/>
* can be blank	
<input type="button" value="Apply"/>	

Figure 81: SMS Configuration for example 3

**Example 4**

Control the Router Sending SMS from Two Phone Numbers

SMS Configuration	
<input type="checkbox"/>	Send SMS on power up
<input type="checkbox"/>	Send SMS on connect to mobile network
<input type="checkbox"/>	Send SMS on disconnect from mobile network
<input type="checkbox"/>	Send SMS when datalimit is exceeded
<input type="checkbox"/>	Send SMS when binary input on I/O port (BIN0) is active
<input type="checkbox"/>	Add timestamp to SMS
<input type="checkbox"/>	Enable remote control via SMS
Phone Number 1	<input type="text"/>
Phone Number 2	<input type="text"/>
Phone Number 3	<input type="text"/>
Unit ID *	<input type="text"/>
BINO - SMS *	<input type="text"/>
<input checked="" type="checkbox"/>	Enable remote control via SMS
Phone Number 1	<input type="text" value="728123456"/>
Phone Number 2	<input type="text" value="766254864"/>
Phone Number 3	<input type="text"/>
<input type="checkbox"/>	Enable AT-SMS protocol on expansion port
Baudrate	<input type="text" value="9600"/>
<input type="checkbox"/>	Enable AT-SMS protocol over TCP
TCP Port	<input type="text"/>
* can be blank	
<input type="button" value="Apply"/>	

Figure 82: SMS Configuration for example 4

### 3.18.8 SNMP

The *SNMP* page allows you to configure the SNMP v1/v2 or v3 agent, which transmits information about the router and its expansion ports (if applicable) to a management station. To access the *SNMP* page, click *SNMP* in the *Configuration* → *Services* section of the main menu.

SNMP (Simple Network Management Protocol) provides status information about network elements such as routers or endpoint devices. In SNMP v3, communication is secured through user-specific encryption and authentication. To enable the SNMP service, select the *Enable SNMP agent* checkbox. IPv6 is supported for SNMP traps as well.

#### Info

*Name*, *Location*, *Contact*, and *Custom* identification fields are now configured in the *Configuration* → *System* → *Identification* menu. These fields are no longer present in the SNMP configuration page.

Item	Description
<i>Enable SNMP agent</i>	Turns on the SNMP agent, which allows the router to be managed and monitored using SNMP protocols.
<i>Enable SNMPv1/v2 access</i>	Enables access for SNMPv1 and SNMPv2 protocols. Enter community strings for read and write access.
<i>Community (Read/Write)</i>	Specify the community strings for SNMPv1/v2 access (for read and write operations, respectively). Default is typically <code>public</code> for read and <code>private</code> for write.
<i>Enable SNMPv3 access</i>	Activates configuration options for SNMPv3, allowing for stronger authentication and encryption.
<i>Username</i>	Set the username for SNMPv3, independently for read and write access.
<i>Authentication</i>	Select the authentication algorithm (e.g., SHA-512) for SNMPv3 identity verification.
<i>Authentication Password</i>	Password for generating the authentication key.
<i>Privacy</i>	Select the encryption algorithm (e.g., AES) used to secure SNMPv3 communication.
<i>Privacy Password</i>	Password for encrypting SNMPv3 messages.
<i>Enable I/O extension</i>	Allows monitoring and reporting of digital I/O signals available on the router.
<i>Enable M-BUS extension</i>	Enables support for M-BUS (Meter-Bus) devices. Configure baudrate, parity, and stop bits as required for your metering hardware. External RS232/M-BUS converters may be needed.
<i>Baudrate, Parity, Stop Bits</i>	Configure communication parameters for the M-BUS interface.
<i>Enable reporting to supervisory system</i>	Enables the transmission of statistical and location data to a supervisory or monitoring server.
<i>Address</i>	Destination IP address or hostname for the supervisory system.
<i>Period</i>	Reporting interval in minutes (1–1440).
<i>Location period if moving / halted</i>	Available for GNSS models only. Defines the interval in seconds (0–864000) for location reporting. GNSS service must be enabled. Separate values can be configured for periods when the device is moving and when it is stationary.

Table 77: SNMP configuration items description

SNMP Configuration			
<input checked="" type="checkbox"/> Enable SNMP agent			
<input checked="" type="checkbox"/> Enable SNMPv1/v2 access			
Community	Read	Write	
	<input type="text" value="public"/>	<input type="text" value="private"/>	
<input type="checkbox"/> Enable SNMPv3 access			
Username	<input type="text"/>	<input type="text"/>	
Authentication	<input type="text" value="SHA-512"/>	<input type="text" value="SHA-512"/>	
Authentication Password	<input type="text"/>	<input type="text"/>	
Privacy	<input type="text" value="AES"/>	<input type="text" value="AES"/>	
Privacy Password	<input type="text"/>	<input type="text"/>	
<input type="checkbox"/> Enable I/O extension			
<input type="checkbox"/> Enable M-BUS extension			
Baudrate	<input type="text" value="300"/>		
Parity	<input type="text" value="even"/>		
Stop Bits	<input type="text" value="1"/>		
<input type="checkbox"/> Enable reporting to supervisory system			
Address	<input type="text"/>		
Period	<input type="text"/>	min	1-1440 min
Location period if moving	<input type="text" value="60"/>	sec	0-864000 sec, needs GNSS on
Location period if halted	<input type="text" value="60"/>	sec	0-864000 sec, needs GNSS on
* can be blank			
<input type="button" value="Apply"/>			

Figure 83: SNMP configuration page

Activating the *Enable I/O extension* function allows you to monitor the digital I/O inputs on the router.

#### Info

Enabling the *Enable M-BUS extension* option and configuring the *Baudrate*, *Parity*, and *Stop Bits* settings allows you to monitor the status of meters connected via the MBUS interface. While the MBUS expansion port is not currently supported, it is possible to use an external RS232/MBUS converter.

Each monitored value is uniquely identified using a numerical identifier called an *OID* (Object Identifier). This identifier consists of a sequence of numbers separated by dots, forming a hierarchical tree structure. Each OID derives from its parent identifier, appending an additional number to indicate its position in the hierarchy. The figure below illustrates the fundamental tree structure used for creating OIDs.

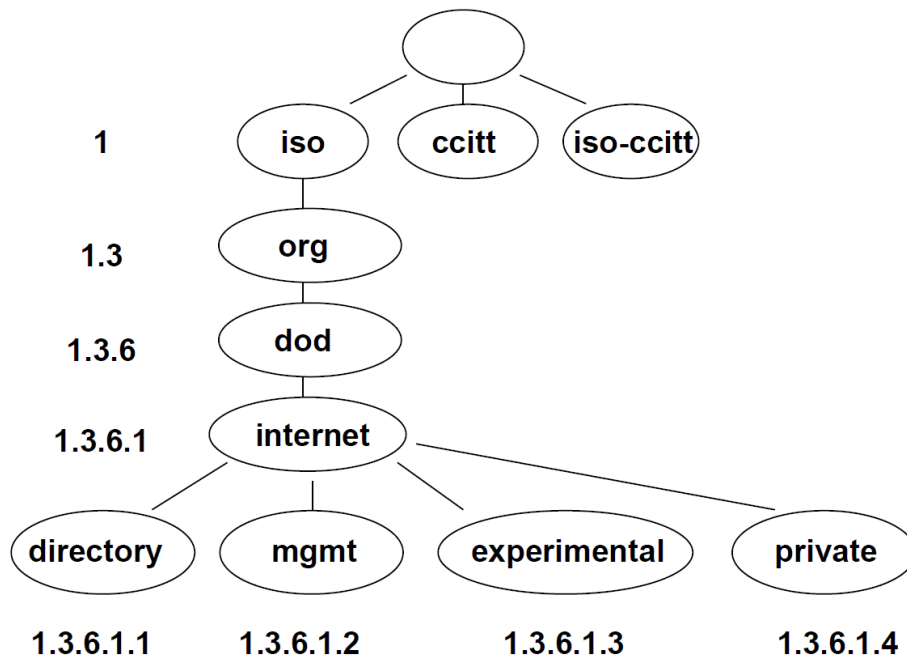

Figure 84: OID basic structure

The SNMP values specific to Advantech routers form a hierarchical tree starting at OID `.1.3.6.1.4.1.30140`. This OID can be interpreted as follows:

**iso.org.dod.internet.private.enterprises.conel**

This means that the router provides, for example, information about the internal temperature (OID `1.3.6.1.4.1.30140.3.3`) or power voltage (OID `1.3.6.1.4.1.30140.3.4`).

For digital inputs and outputs, the following OID range is used:

OID	Description
.1.3.6.1.4.1.30140.2.3.1.0	Digital input BIN0 (values: 0,1)
.1.3.6.1.4.1.30140.2.3.2.0	Digital output OUT0 (values: 0,1)
.1.3.6.1.4.1.30140.2.3.3.0	Digital input BIN1 (values: 0,1)

Table 78: Object identifiers for digital inputs and outputs

**Info**

The list of available and supported OIDs, along with other details, can be found in the application note *SNMP Object Identifiers* [12].

The next figure illustrates SNMP browsing in the *MIB Browser*.

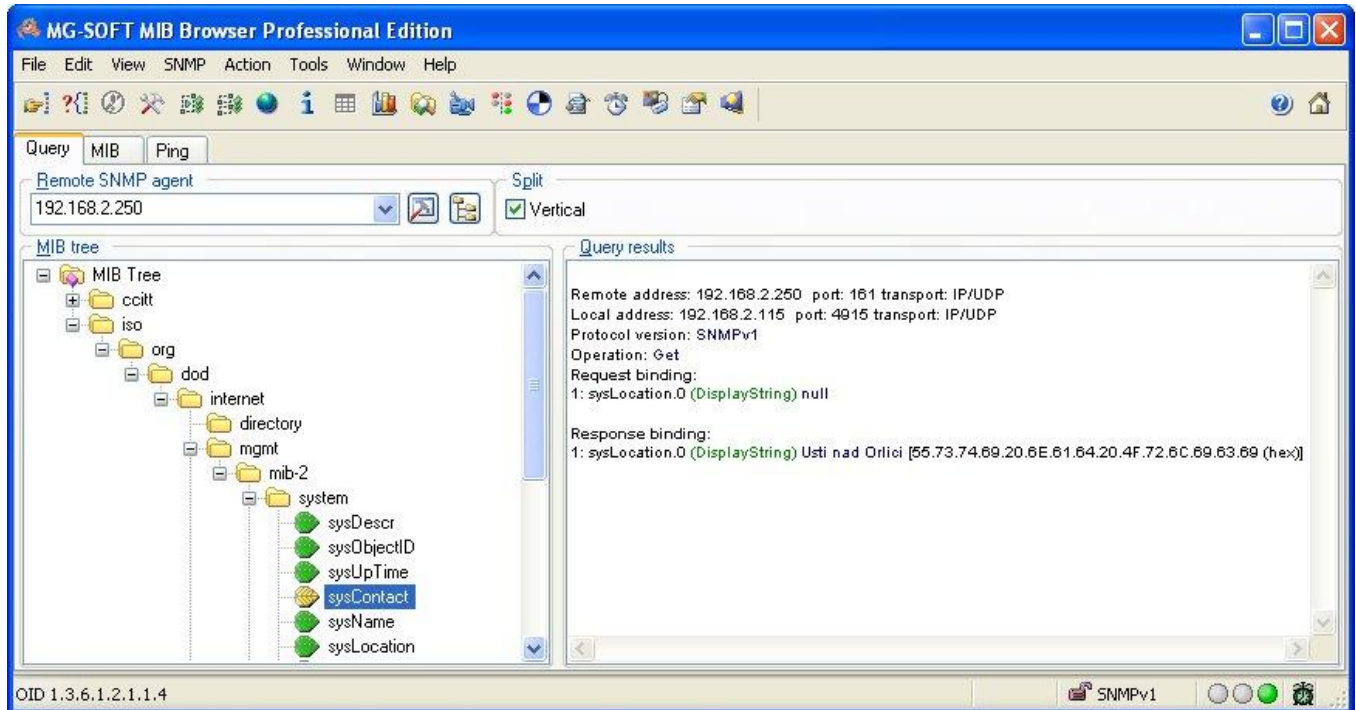

Figure 85: MIB browser example

To access a specific device, enter the IP address of the SNMP agent (the router) in the *Remote SNMP Agent* field. The dialog displays the internal variables in the MIB tree after entering the IP address. Additionally, you can check the status of internal variables by entering their corresponding OID.

The path to the SNMP objects is:

*iso → org → dod → internet → private → enterprises → Conel → protocols*

The path to router-specific information is:

*iso → org → dod → internet → mgmt → mib-2 → system*

### 3.18.9 SSH

The Secure Shell (SSH) service allows for secure command-line access to the router's operating system. To configure the SSH server, navigate to *Services* → *SSH*.

#### Info

**Access Restriction:** Please note that only users assigned the *Admin* role are authorized to log in to the router via SSH. Users with a standard *User* role cannot access the command line.

SSH Configuration

Enable SSH service

Port

Session Timeout  sec 60-100000 sec

Login Banner

Keep the current SSH key  
 Generate a new SSH key

Key Type  ▼

Figure 86: SSH server configuration page

### General Settings

Item	Description
<i>Enable SSH service</i>	Enables or disables the SSH server on the router.
<i>Port</i>	The TCP port on which the SSH server will listen for incoming connections. The default is port 22.
<i>Session Timeout</i>	The duration of inactivity (in minutes) after which an SSH session will be automatically disconnected.
<i>Login Banner</i>	A custom message that will be displayed to users before they are prompted for their login credentials.

Table 79: General SSH settings

## Host Key Management

The SSH host key is a unique cryptographic key used by clients to verify the router's identity and prevent man-in-the-middle attacks.

### Info

When you connect to the router via SSH for the first time, your client will prompt you to accept the host key's fingerprint. If the host key ever changes (e.g., after a new one is generated), your client will display a security warning. This is expected behavior.

Item	Description
<i>Keep the current SSH key</i>	Retains the existing host key. This is the default and recommended option for normal operation.
<i>Generate a new SSH key</i>	Discards the current key and generates a new one. This is typically only done for security policy reasons.
<i>Key Type</i>	The cryptographic algorithm used for the host key. <b>ED25519</b> is a modern, fast, and secure elliptic curve algorithm. <b>RSA</b> is an older, widely supported standard.

Table 80: SSH host key settings

### 3.18.10 Syslog

The Syslog service collects and manages system messages from the router's operating system and various applications. To configure this service, navigate to *Services* → *Syslog*.

The collected logs can be viewed on the *Status* → *System Log* page (see Chapter 2.11 *System Log*) or via the command line with the `slog` command.

Syslog Configuration	
Log Size Limit	<input type="text" value="10"/> KIB <span style="float: right;">1-1000000 KiB</span>
Log Persistent	<input type="text" value="yes"/> ▼
Minimum Severity	<input type="text" value="Informational"/> ▼
Mark Message Period	<input type="text"/> sec
Read Kernel Log	<input type="checkbox"/>
Enable Forwarding	<input type="checkbox"/>
Protocol	<input type="text" value="SSL/TLS"/> ▼
Remote Host	<input type="text"/>
Remote Port	<input type="text" value="514"/>
Device ID *	<input type="text"/>
Authentication	<input type="text" value="Certificate validity"/> ▼
Acceptable Peers	<input type="text"/>
CA Certificates	<div style="border: 1px solid #ccc; height: 40px; width: 100%;"></div> <input type="button" value="Load From File..."/>
Local Certificate *	<div style="border: 1px solid #ccc; height: 40px; width: 100%;"></div> <input type="button" value="Load From File..."/>
Local Private Key *	<div style="border: 1px solid #ccc; height: 40px; width: 100%;"></div> <input type="button" value="Load From File..."/>
* can be blank	
<input type="button" value="Apply"/>	

Figure 87: Syslog configuration page

## Local Logging

These settings control how logs are stored on the router itself.

Setting	Description
<i>Log Size Limit</i>	Sets the maximum size (in KiB) for the local log files. The default is 10 KiB.
<i>Log Persistent</i>	If enabled, the system log will be saved in persistent memory and will survive a router reboot.
<i>Minimum Severity</i>	Sets the minimum severity level for messages to be logged by the system. Levels range from <i>Emergency</i> (highest severity, least detail) to <i>Debug</i> (lowest severity, most detail). <b>Note:</b> Some components, such as IPsec or certain Router Apps, have their own independent logging level settings. These act as a secondary filter. A service-specific setting can make that service <b>less</b> verbose than the global setting, but it cannot force the system to log messages that fall below the global <i>Minimum Severity</i> level.
<i>Mark Message Period</i>	Sets a time interval for the router to write a – MARK – message to the log, which acts as a keepalive indicator.
<i>Read Kernel Log</i>	Check this to include kernel-level messages (e.g., firewall logs, device notifications) in the system log.

Table 81: Local logging settings

## Remote Forwarding

The router can forward log messages in real-time to a remote Syslog server for centralized storage and analysis.

Setting	Description
<i>Enable Forwarding</i>	Enables the forwarding of all log messages to a remote host.
<i>Protocol</i>	The transport protocol for forwarding: <i>UDP</i> , <i>TCP</i> , or <i>SSL/TLS</i> for a secure connection.
<i>Remote Host</i>	The hostname or IP address of the remote Syslog server.
<i>Remote Port</i>	The port number on which the remote server is listening.
<i>Device ID</i>	A custom identifier for the router, used in the forwarded log messages. If left blank, the default ID <i>Router</i> is used.

Table 82: Remote forwarding settings

## Remote Server Authentication

These settings configure authentication when using the *SSL/TLS* protocol for secure forwarding.

Setting	Description
<i>Authentication</i>	The method used to authenticate the remote server: <ul style="list-style-type: none"> <li>• <b>None (encryption only):</b> Encrypts the connection but does not authenticate the server.</li> <li>• <b>Certificate fingerprint:</b> Authenticates the server by matching its certificate fingerprint against the one in <i>Acceptable Peers</i>.</li> <li>• <b>Certificate validity:</b> Authenticates any server that presents a valid certificate signed by the specified CA.</li> <li>• <b>Certified peer name:</b> Authenticates the server by checking its certificate's validity and matching its DNS name or Common Name against the <i>Acceptable Peers</i> list.</li> </ul>
<i>Acceptable Peers</i>	A list of accepted certificate fingerprints (SHA1) or DNS/Common Names. Wildcards (e.g., *.example.net) are supported for names.
<i>CA Certificates</i>	A file containing the full CA certificate chain in PEM format, used to validate the remote server's certificate.
<i>Local Certificate</i>	A local client certificate (in PEM format) to present to the remote server if it requires client authentication.
<i>Local Private Key</i>	The private key corresponding to the <i>Local Certificate</i> .

Table 83: Remote server authentication settings

### 3.18.11 Telnet

The Telnet service provides unencrypted, text-based command-line access to the router. To configure it, navigate to *Services* → *Telnet*.

#### Warning

Telnet is an insecure protocol. All data, including usernames and passwords, is transmitted in plain text. It is strongly recommended to use the secure SSH service instead.

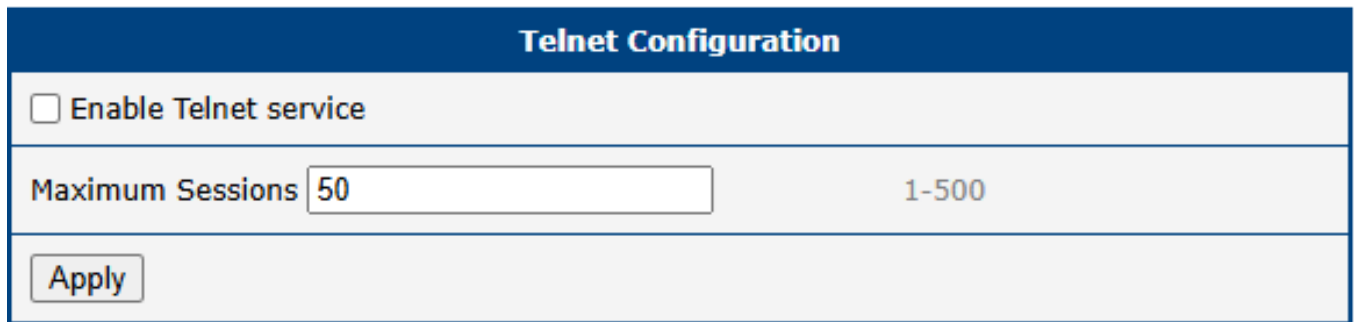

Figure 88: Telnet server configuration page

Item	Description
<i>Enable Telnet service</i>	Enables the Telnet server on the router.
<i>Maximum Sessions</i>	The maximum number of concurrent Telnet sessions allowed. The allowed range is from 1 to 500.

Table 84: Telnet configuration settings

### 3.19 Peripheral Ports



**Info**  
Some interfaces may not be available for all models.

Configuration of physical interfaces such as RS-232, RS-485, USB serial converter, and digital Inputs/Outputs is now accessible from the *Configuration* → *Peripheral Ports* menu. Each interface is configured using its own subpage. Below, each port type is described in its own section.

#### 3.19.1 RS-232 Port

On the RS-232 Port configuration page, you can activate the port by ticking the *Enable access over TCP/UDP* checkbox. Additional settings are detailed in the table below. Support is provided for both IPv4 and IPv6 TCP/UDP client/server configurations.

RS-232 Serial Port Configuration			
<input type="checkbox"/> Enable access over TCP/UDP			
Baudrate	<input type="text" value="9600"/>	▼	
Data Bits	<input type="text" value="8"/>	▼	
Parity	<input type="text" value="none"/>	▼	
Stop Bits	<input type="text" value="1"/>	▼	
Flow Control	<input type="text" value="none"/>	▼	
Split Timeout	<input type="text" value="20"/>	msec	1-10000 msec
Protocol	<input type="text" value="TCP"/>	▼	
Mode	<input type="text" value="server"/>	▼	
Server Address	<input type="text"/>		
TCP Port	<input type="text"/>		
Inactivity Timeout *	<input type="text"/>	sec	1-86400 sec
<input type="checkbox"/> Reject new connections			
<input type="checkbox"/> Check TCP connection			
Keepalive Time	<input type="text" value="3600"/>	sec	1-86400 sec
Keepalive Interval	<input type="text" value="10"/>	sec	1-120 sec
Keepalive Probes	<input type="text" value="5"/>		1-10
* can be blank			
<input type="button" value="Apply"/>			

Figure 89: RS-232 serial port configuration

Item	Description
<i>Baudrate</i>	Configurable communication speed: <b>300, 600, 1200, 2400, 4800, 9600</b> (default), <b>19200, 38400, 57600, 115200, 230400</b> .
<i>Data Bits</i>	Number of data bits: <b>5, 6, 7, 8</b> (default).
<i>Parity</i>	Parity control bit: <ul style="list-style-type: none"> <li>• <b>None</b> – Data is sent without a parity bit.</li> <li>• <b>Even</b> – Data is sent with even parity.</li> <li>• <b>Odd</b> – Data is sent with odd parity.</li> </ul>
<i>Stop Bits</i>	Number of stop bits: <b>1</b> (default), <b>2</b> .
<i>Flow Control</i>	Select the flow control method: <b>None</b> or <b>Hardware</b> .
<i>Split Timeout</i>	Time threshold for message segmentation. If the gap between two characters exceeds this value (in milliseconds), any buffered characters are sent over the network.
<i>Protocol</i>	Communication protocol: <ul style="list-style-type: none"> <li>• <b>TCP</b> – Communication using the connection-oriented TCP protocol.</li> <li>• <b>UDP</b> – Communication using the connectionless UDP protocol.</li> </ul>
<i>Mode</i>	Connection mode for TCP protocol: <ul style="list-style-type: none"> <li>• <b>server</b> – The router listens for incoming TCP connection requests on the specified port.</li> <li>• <b>client</b> – The router initiates a connection to a TCP server using the specified IP address and port.</li> </ul>
<i>Server Address</i>	When in <i>client</i> mode, specify the IP address or domain name of the remote server. Both IPv4 and IPv6 are supported.
<i>TCP Port</i>	The TCP/UDP port for communication. This setting applies to both server and client modes.
<i>Inactivity Timeout</i>	The time in seconds after which an inactive TCP/UDP connection is automatically terminated.
<i>Reject new connections</i>	If enabled, the router rejects new incoming connections when one is already active, enforcing a single-client connection.
<i>Check TCP connection</i>	If enabled, the router actively monitors the TCP connection status using keepalive packets.
<i>Keepalive Time</i>	The time interval in seconds after which the router sends a keepalive probe to verify the connection.
<i>Keepalive Interval</i>	The duration in seconds the router waits for a response to a probe before re-sending it.
<i>Keepalive Probes</i>	The number of unanswered probes before the connection is considered inactive.

Table 85: RS-232 serial port configuration items

### Ethernet-to-Serial Communication Example

This scenario demonstrates how to use the router as a gateway to connect a PC on an Ethernet network to a remote serial device. As shown in the figure, a PC with the IP address 192.168.1.100 sends data to the remote router (10.0.0.2) on TCP port 2000. This remote router is configured in *TCP Server* mode and listens for incoming connections. Once a connection is established, it forwards all data from the TCP socket to its RS-232 port, which is connected to the PLC. The first router (192.168.1.1) serves as the default gateway for the PC.

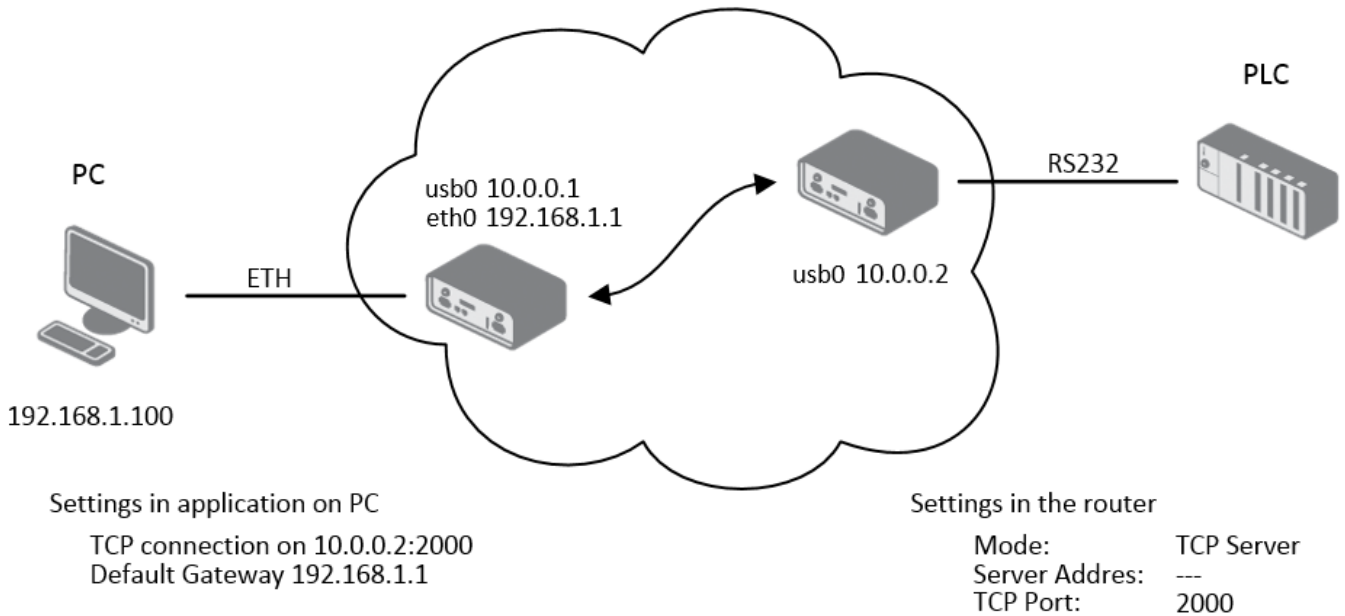

Figure 90: Ethernet-to-serial communication configuration example

### Serial Interface Communication (Serial Tunnel) Example

This example illustrates how to create a transparent serial tunnel over an IP network, effectively extending a serial connection over a long distance. The PC is connected via RS-232 to the first router (10.0.0.1), which is configured in *TCP Client* mode. It initiates a connection to the second router (10.0.0.2) on port 2000. The second router, configured as a *TCP Server*, is connected to the PLC via its RS-232 port. Data sent from the PC is automatically tunneled over the TCP connection to the second router and then passed to the PLC.

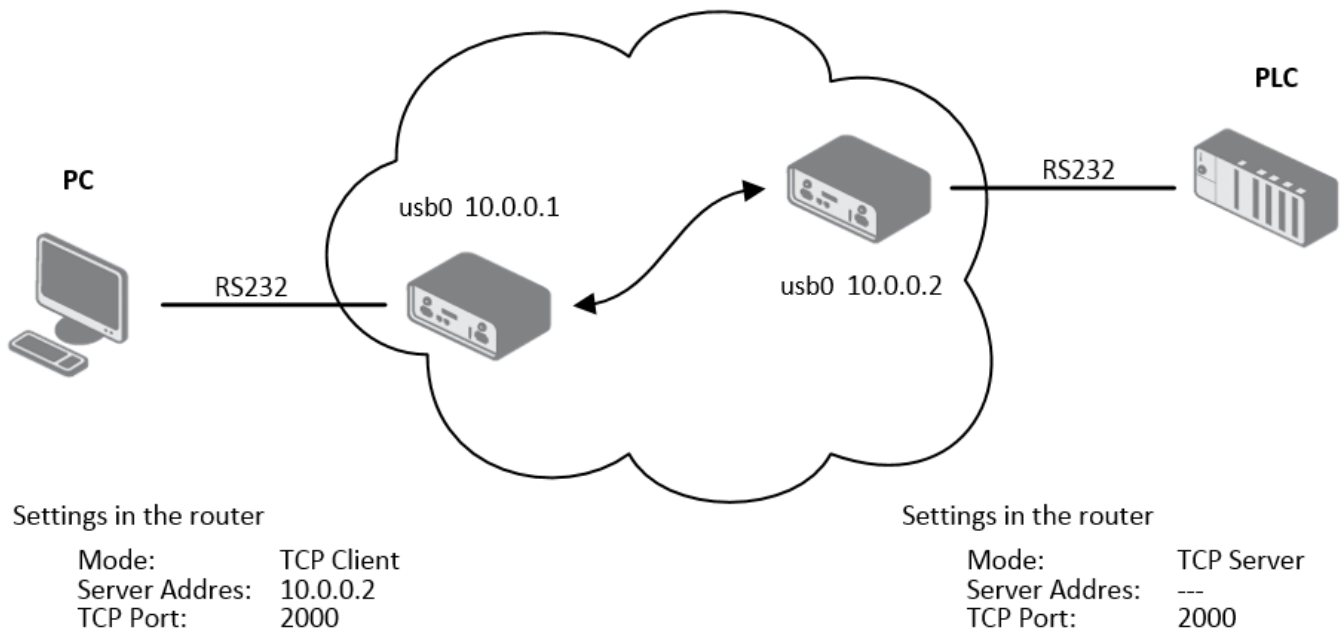

Figure 91: Serial interface configuration example

### 3.19.2 Inputs/Outputs

**Info**



Starting from router firmware version 6.6.0, the USR LED settings on this page replace the original *USR LED Management* RouterApp, and it is strongly recommended to use this built-in feature instead of the app.

On the *Inputs/Outputs* page, you can manually turn a digital output on or off and define the operation mode for the router’s USR LED. In the image below, *Digital Output 0* is *On* and can be turned off by clicking the *Off* button. Conversely, *Digital Output 1* is *Off* and can be turned on by clicking the *On* button.

Inputs/Outputs Configuration

Digital Output 0:

Digital Output 1:

---

Enable USR LED Management

Operation Mode

---

Figure 92: Inputs/Outputs configuration example

By enabling *Enable USR LED Management*, you can set the desired operation mode for the USR LED. The available modes are described in the table below:

Item	Description
<i>Always OFF</i>	The LED is permanently off.
<i>Always ON</i>	The LED is permanently on. This is useful for physically locating the router among other devices.
<i>Digital Input x</i>	The LED lights when digital input <i>x</i> is <i>On</i> . The state is updated every 100 ms.
<i>Digital Output x</i>	The LED lights when digital output <i>x</i> is <i>On</i> . The state is updated every 100 ms.
<i>RS-xxx Rx activity</i>	The LED lights when the serial interface on peripheral port <i>xxx</i> is receiving data.
<i>RS-xxx Tx activity</i>	The LED lights when the serial interface on peripheral port <i>xxx</i> is transmitting data.
<i>RS-xxx Rx and Tx activity</i>	The LED lights when the serial interface on peripheral port <i>xxx</i> is receiving and/or transmitting data.
<i>WiFi AP activity</i>	The LED lights when a client is connected to the router’s WiFi AP and flashes during communication.
<i>WiFi STA activity</i>	The LED lights when the router is connected to a remote WiFi AP and flashes during communication.
<i>OpenVPN activity</i>	The LED lights when an OpenVPN tunnel is established and has received data.
<i>IPsec active</i>	The LED lights when an IPsec tunnel is established.
<i>WireGuard activity</i>	The LED lights when a WireGuard tunnel is established and has received data.
<i>WebAccess/DMP active</i>	The LED lights when the router is connected to a WebAccess/DMP server.

Table 86: USR LED operation modes overview

## 3.20 System

The System configuration menu contains settings that are common to the entire router system, such as authentication, identification, and automatic updates.

### 3.20.1 Authentication

The *Configuration* → *System* → *Authentication* page allows for the configuration of user authentication methods, password policies, and account lockout settings. The router can authenticate users against its local database or against external RADIUS or TACACS+ servers.

Authentication Configuration			
Two-Factor Authentication	<input type="text" value="disabled"/>		
Mode	<input type="text" value="local user database"/>		
Lock Account After *	<input type="text" value="3"/>	fails	1-100 fails
Count Fails For	<input type="text" value="3600"/>	sec	10-86400 sec
Unlock After	<input type="text" value="60"/>	sec	1-86400 sec
Force Password Complexity	<input type="text" value="very weak"/>		
Expire Password After *	<input type="text"/>	days	1-99998 days
Delay After Fail *	<input type="text" value="1"/>	sec	1-60 sec
Debug	<input type="text" value="disabled"/>		
* can be blank			
<input type="button" value="Apply"/>			

Figure 93: Authentication configuration page

## General Settings

These settings are common across all authentication modes.

Item	Description
<i>Two-Factor Authentication</i>	Enables a second layer of security for user logins. Options include <i>Google Authenticator</i> or <i>OATH</i> . See Chapter for details.
<i>Mode</i>	Selects the primary authentication method: <ul style="list-style-type: none"> <li>• <b>Local user database:</b> Authenticates against the router's local user list (see Chapter <a href="#">5.1 Manage Users</a>).</li> <li>• <b>RADIUS with fallback:</b> Authenticates against a RADIUS server. If the server is unreachable, it falls back to the local database.</li> <li>• <b>RADIUS only:</b> Authenticates only against a RADIUS server. Caution: If the server is unreachable, login will be impossible.</li> <li>• <b>TACACS+ with fallback:</b> Authenticates against a TACACS+ server, with fallback to the local database.</li> <li>• <b>TACACS+ only:</b> Authenticates only against a TACACS+ server. Caution: If the server is unreachable, login will be impossible.</li> </ul>

Table 87: General authentication configuration options

Item	Description
<i>Lock Account After</i>	The number of failed login attempts before an account is locked.
<i>Count Fails For</i>	The time window in seconds during which failed attempts are counted.
<i>Unlock After</i>	The duration in seconds after which a locked account is automatically unlocked.
<i>Force Password Complexity</i>	<p>Enforces minimum password strength requirements. There are four character classes: uppercase letters (A-Z), lowercase letters (a-z), digits (0-9), and other characters (e.g., <code>!@#\$.</code>).</p> <ul style="list-style-type: none"> <li>• <b>Very Weak:</b> <ul style="list-style-type: none"> <li>○ Must be at least 6 characters long.</li> <li>○ Must not contain the username.</li> <li>○ Must not be a palindrome.</li> </ul> </li> <li>• <b>Weak:</b> <ul style="list-style-type: none"> <li>○ Must be at least 8 characters long.</li> <li>○ Must contain characters from at least 2 of the 4 classes.</li> <li>○ Must not contain the username.</li> <li>○ Must not be a palindrome.</li> </ul> </li> <li>• <b>Good:</b> <ul style="list-style-type: none"> <li>○ Must be at least 12 characters long.</li> <li>○ Must contain characters from at least 3 of the 4 classes.</li> <li>○ Must not contain more than 3 identical consecutive characters.</li> <li>○ Must not contain the username.</li> <li>○ Must not be a palindrome.</li> </ul> </li> <li>• <b>Strong:</b> <ul style="list-style-type: none"> <li>○ Must be at least 16 characters long.</li> <li>○ Must contain characters from all 4 classes.</li> <li>○ Must not contain more than 2 identical consecutive characters.</li> <li>○ Must not contain the username.</li> <li>○ Must not be a palindrome.</li> </ul> </li> </ul>
<i>Expire Password After</i>	The number of days until a user password expires, forcing a change on next login. See Chapter .
<i>Delay After Fail</i>	The time in seconds the login screen is disabled after a failed attempt.
<i>Debug</i>	Enables detailed authentication-related messages in the system log.

Table 87: General authentication configuration options (continued)

## RADIUS Mode

To use RADIUS for authentication, select either *RADIUS with fallback* or *RADIUS only* and configure the server details.

Authentication Configuration				
Two-Factor Authentication	disabled ▼			
Mode	RADIUS only ▼			
RADIUS Server(s)				
Server	Port *	Secret	Timeout *	
<input type="checkbox"/> [ ]	[ ]	[ ]	[ ] sec	1-60 sec
<input type="checkbox"/> [ ]	[ ]	[ ]	[ ] sec	1-60 sec
Take Over Server Users	disabled ▼			
Default User Role	admin ▼			
Delay After Fail *	1	sec	1-60 sec	
Debug	disabled ▼			
* can be blank				
<input type="button" value="Apply"/>				

Figure 94: RADIUS configuration

### Warning

For a RADIUS user to log in, a corresponding user account must exist on the router locally. This account can be created manually (see Chapter 5.1 *Manage Users*) or automatically by enabling the *Take Over Server Users* option.

Item	Description
<i>Server</i>	The IP address of the primary and optional secondary RADIUS server.
<i>Port</i>	The UDP port of the RADIUS server (default is 1812).
<i>Secret</i>	The shared secret used to encrypt communication with the RADIUS server.
<i>Timeout</i>	The time in seconds to wait for a response from the RADIUS server.
<i>Take Over Server Users</i>	If enabled, a local user account will be created automatically upon successful RADIUS authentication if one does not already exist. The local account is created without a password.
<i>Default User Role</i>	Assigns a default role ( <i>Admin</i> or <i>User</i> ) to users created via the <i>Take Over</i> feature, unless a role is provided by the RADIUS server via the <i>Service-Type</i> attribute. <ul style="list-style-type: none"> <li><i>Administrative-User</i>: Assigns the <i>Admin</i> role.</li> <li><i>NAS-Prompt-User</i>: Assigns the <i>User</i> role.</li> </ul>

Table 88: RADIUS configuration options

## TACACS+ Mode

To use TACACS+ for authentication, select either *TACACS+ with fallback* or *TACACS+ only* and configure the server details.

Authentication Configuration			
Two-Factor Authentication	disabled ▼		
Mode	TACACS+ only ▼		
TACACS+ Server(s)			
Authentication Type	ASCII ▼		
Timeout *	<input type="text"/>	sec	1-60 sec
Server	Port *	Secret	
<input type="checkbox"/>	<input type="text"/>	<input type="text"/>	<input type="text"/>
<input type="checkbox"/>	<input type="text"/>	<input type="text"/>	<input type="text"/>
Take Over Server Users	disabled ▼		
Default User Role	admin ▼		
Delay After Fail *	<input type="text" value="1"/>	sec	1-60 sec
Debug	disabled ▼		
* can be blank			
<input type="button" value="Apply"/>			

Figure 95: TACACS+ configuration

### Warning

As with RADIUS, a corresponding local user account is required for TACACS+ authentication. This account can be created manually or automatically with the *Take Over Server Users* option, as detailed in Chapter 5.1 *Manage Users*.

Item	Description
<i>Authentication Type</i>	The authentication protocol to use: <i>ASCII</i> , <i>PAP</i> , or <i>CHAP</i> .
<i>Timeout</i>	The time in seconds to wait for a response from the TACACS+ server.
<i>Server</i>	The IP address of the primary and optional secondary TACACS+ server.
<i>Port</i>	The TCP port of the TACACS+ server (default is 49).
<i>Secret</i>	The shared secret used to encrypt communication with the TACACS+ server.
<i>Take Over Server Users</i>	If enabled, a local user account will be created automatically upon successful TACACS+ authentication if one does not already exist. The local account is created without a password.
<i>Default User Role</i>	Assigns a default role ( <i>Admin</i> or <i>User</i> ) to users created via the <i>Take Over</i> feature.

Table 89: TACACS+ configuration options

### 3.20.2 Identification

The *Configuration* → *System* → *Identification* page allows you to define several strings used to identify the router. These values serve multiple purposes:

- The *Name* and *Location* strings are displayed in the top-right corner of the web interface for easy identification.
- The *Name*, *Location*, *Contact*, and *Custom* fields are all exposed via the Simple Network Management Protocol (SNMP) for remote monitoring, as detailed in Chapter 3.18.8 *SNMP*.

#### Info

Previously, these settings were located on the SNMP configuration page. They have been moved here to serve as a central point for router identification.

**Identification Configuration**

<b>Name *</b>	<input type="text"/>
<b>Location *</b>	<input type="text"/>
<b>Contact *</b>	<input type="text"/>
<b>Custom *</b>	<input type="text"/>
<b>Hostname</b>	<input type="text" value="Router"/>

\* *can be blank*

Figure 96: Identification configuration page

Item	Description
<i>Name</i>	A custom name for the router (e.g., "Main Office Gateway"). This is also used as the SNMP System Name (sysName).
<i>Location</i>	The physical location of the router (e.g., "Server Room A"). This is used as the SNMP System Location (sysLocation).
<i>Contact</i>	Contact information for the person responsible for the device (e.g., an email address or phone number). This is used as the SNMP System Contact (sysContact).
<i>Custom</i>	A custom string for any additional information. This is used as the SNMP System Location (infoCustom).
<i>Hostname</i>	The hostname of the router, used to identify the device on the local network (e.g., in DHCP leases).

Table 90: Identification configuration items

### 3.20.3 Automatic Update

The router can be configured to automatically download and apply firmware and configuration updates from a remote server or a local USB drive. This feature is essential for managing large-scale deployments and ensuring that devices are always up-to-date. The settings are located on the *Configuration* → *System* → *Automatic Update* page.

Automatic Update

Enable automatic update of configuration

Enable automatic update of firmware

Base URL

Unit ID \*

Decryption Password \*

Update Window Start  ▼

Update Window Length \*  min 0-480 min

---

Skip Certificate Verification

CA Certificate \*

---

\* can be blank

Figure 97: Automatic Update configuration page

### Update Configuration

The following table describes the parameters for configuring the automatic update process.

Item	Description
<i>Enable automatic update of configuration</i>	Enables the automatic update of the router's configuration file.
<i>Enable automatic update of firmware</i>	Enables the automatic update of the router's firmware.

Table 91: Automatic Update configuration options

Item	Description
<i>Base URL</i>	The base URL of the remote server where update files are stored. The default protocol is HTTPS. To use a different protocol (HTTP, FTP, or FTPS), the prefix must be specified explicitly (e.g., <a href="http://myupdateserver.com">http://myupdateserver.com</a> ).
<i>Unit ID</i>	A custom identifier used as the filename for the configuration file. If this field is empty, the router defaults to using its ETH0 MAC address as the filename.
<i>Decryption Password</i>	The password required to decrypt an encrypted configuration file.
<i>Update Window Start</i>	The hour (1-24) when the daily update check should begin. If set to <i>dynamic</i> , the check runs five minutes after boot and every 24 hours thereafter.
<i>Update Window Length</i>	A duration in minutes that defines a window of time, starting at the <i>Update Window Start</i> , during which the update will be performed at a random moment. This helps to distribute the load on the update server in large deployments.
<i>Skip Certificate Verification</i>	If checked, the router will not validate the SSL/TLS certificate of the remote HTTPS/FTPS server.
<i>CA Certificate</i>	The custom CA certificate used for server validation.

Table 91: Automatic Update configuration options (continued)

## File Naming Conventions

The router looks for files with specific names on the update source. All files must be in a `tar.gz` archive.

- **Firmware:** The firmware filename is composed of the router model and a `.bin` extension (e.g., `icr-440x.bin`). The exact filename can be found on the *Administration* → *Update Firmware* page (see Chapter 5.9 *Update Firmware*). A corresponding version file (`*.ver`) must also be present on the server.
- **Configuration:** The configuration filename is determined by the *Unit ID*. If the *Unit ID* is specified, that value is used as the filename (e.g., `test.cfg`). If it is left blank, the router will look for a file named after its ETH0 MAC address, with colons replaced by dots (e.g., `00.11.22.33.44.55.cfg`).

### Warning

- Always upload both the `*.bin` and `*.ver` files to the server for firmware updates. If the `*.ver` file is missing and the server returns an incorrect success code, the router may enter a continuous download loop.
- Firmware updates may introduce incompatibilities with installed Router Apps. Always check the application notes for compatibility information and update Router Apps as needed.
- The automatic update process will always run five minutes after a manual firmware upgrade, regardless of the scheduled time.

## Configuration Examples

### Example 1: Scheduled Update

In this example, an ICR-4401 router is configured to check for a new firmware or configuration file daily at 1:00 AM from a specific URL.

- Firmware URL: <https://example.com/icr-440x.bin>
- Configuration URL: <https://example.com/test.cfg>

### Automatic Update

Enable automatic update of configuration  
 Enable automatic update of firmware

Base URL

Unit ID \*

Decryption Password \*

Update Window Start

Update Window Length \*  min 0-480 min

---

Skip Certificate Verification   
Use Custom CA Certificate

CA Certificate \*

---

\* can be blank

Figure 98: Example of a scheduled automatic update

**Example 2: Update Based on MAC Address with Encrypted Configuration**

This example shows an ICR-4161 router configured to check for updates within a two-hour window. The configuration file is encrypted and identified by the router's MAC address.

- Firmware URL: <https://example.com/icr-416x.bin>
- Configuration URL: <https://example.com/00.11.22.33.44.55.cfg>

### Automatic Update

Enable automatic update of configuration  
 Enable automatic update of firmware

Base URL

Unit ID \*

Decryption Password \*

Update Window Start

Update Window Length \*  min      0-480 min

---

Skip Certificate Verification

Use Custom CA Certificate

CA Certificate \*

---

\* can be blank

Figure 99: Example of an automatic update using the MAC address

### 3.21 Events

The *Configuration* → *Events* page provides a powerful system for triggering automated actions in response to specific system events. This feature allows you to create custom notifications and responses for monitoring the router’s status and health.

#### Info



Starting with firmware version 6.6.0, this functionality replaces the legacy *Event Notificator* RouterApp. It is strongly recommended to use this built-in feature instead of the old RouterApp.

To begin, check the *Enable events notifications* box at the top of the page.

Events Configuration

Enable events notifications

Event	SNMP	Syslog	SMS Group 1	SMS Group 2	E-mail Group 1	E-mail Group 2	E-mail Group 3	E-mail Group 4	Script 1	Script 2	ID
System Rebooted	<input type="checkbox"/>	<input type="checkbox"/>	<input type="checkbox"/>	<input type="checkbox"/>	<input type="checkbox"/>	<input type="checkbox"/>	<input type="checkbox"/>	<input type="checkbox"/>	<input type="checkbox"/>	<input type="checkbox"/>	1
Configuration Changed	<input type="checkbox"/>	<input type="checkbox"/>	<input type="checkbox"/>	<input type="checkbox"/>	<input type="checkbox"/>	<input type="checkbox"/>	<input type="checkbox"/>	<input type="checkbox"/>	<input type="checkbox"/>	<input type="checkbox"/>	2
Password Changed	<input type="checkbox"/>	<input type="checkbox"/>	<input type="checkbox"/>	<input type="checkbox"/>	<input type="checkbox"/>	<input type="checkbox"/>	<input type="checkbox"/>	<input type="checkbox"/>	<input type="checkbox"/>	<input type="checkbox"/>	3
Login Failed	<input type="checkbox"/>	<input type="checkbox"/>	<input type="checkbox"/>	<input type="checkbox"/>	<input type="checkbox"/>	<input type="checkbox"/>	<input type="checkbox"/>	<input type="checkbox"/>	<input type="checkbox"/>	<input type="checkbox"/>	4
Temperature Reached	<input type="checkbox"/>	<input type="checkbox"/>	<input type="checkbox"/>	<input type="checkbox"/>	<input type="checkbox"/>	<input type="checkbox"/>	<input type="checkbox"/>	<input type="checkbox"/>	<input type="checkbox"/>	<input type="checkbox"/>	5
ETH0 Disconnected	<input type="checkbox"/>	<input type="checkbox"/>	<input type="checkbox"/>	<input type="checkbox"/>	<input type="checkbox"/>	<input type="checkbox"/>	<input type="checkbox"/>	<input type="checkbox"/>	<input type="checkbox"/>	<input type="checkbox"/>	10

Test Triggered	<input type="checkbox"/>	<input type="checkbox"/>	<input type="checkbox"/>	<input type="checkbox"/>	<input type="checkbox"/>	<input type="checkbox"/>	<input type="checkbox"/>	<input type="checkbox"/>	<input type="checkbox"/>	<input type="checkbox"/>	99
Application 1	<input type="checkbox"/>	<input type="checkbox"/>	<input type="checkbox"/>	<input type="checkbox"/>	<input type="checkbox"/>	<input type="checkbox"/>	<input type="checkbox"/>	<input type="checkbox"/>	<input type="checkbox"/>	<input type="checkbox"/>	101
Application 2	<input type="checkbox"/>	<input type="checkbox"/>	<input type="checkbox"/>	<input type="checkbox"/>	<input type="checkbox"/>	<input type="checkbox"/>	<input type="checkbox"/>	<input type="checkbox"/>	<input type="checkbox"/>	<input type="checkbox"/>	102

SMS Group 1	<input type="text"/>	comma-separated list
SMS Group 2	<input type="text"/>	comma-separated list
E-mail Group 1	<input type="text"/>	comma-separated list
E-mail Group 2	<input type="text"/>	comma-separated list
E-mail Group 3	<input type="text"/>	comma-separated list
E-mail Group 4	<input type="text"/>	comma-separated list
Script Path 1	<input type="text"/>	
Script Path 2	<input type="text"/>	

Temperature Limit *	<input type="text"/>	°C	1-100°C
---------------------	----------------------	----	---------

SNMP Manager IPv4 Address	<input type="text"/>
SNMP Manager Port	<input type="text" value="162"/>
SNMP Version	<input type="text" value="3"/>
PDU Type	<input type="text" value="Inform"/>
Engine ID Payload Type	<input type="text" value="ETH0 MAC address"/>
Engine ID Payload *	<input type="text"/>
Engine ID	<input type="text" value="800075BC0302ADFF00009"/>
Context Name *	<input type="text"/>
Username	<input type="text" value="admin"/>
Authentication	<input type="text" value="SHA-512"/>
Authentication Password	<input type="password"/>
Privacy	<input type="text" value="AES"/>
Privacy Password	<input type="password"/>

\* can be blank

Figure 100: Events configuration page

## Event-Action Matrix

The core of this feature is the matrix, which links system events (rows) to specific actions (columns). When a particular event occurs, the router checks this matrix and executes all the actions that are checked in that event's row.

Event	Description
<i>System Rebooted</i>	Triggered when the router finishes its boot sequence.
<i>Configuration Changed</i>	Triggered whenever the router's configuration is modified and saved.
<i>Password Changed</i>	Triggered when a user password is changed.
<i>Login Failed</i>	Triggered after any unsuccessful login attempt to the router, either via the web interface or an SSH connection.
<i>Temperature Reached</i>	Triggered when the internal temperature exceeds the limit defined in the <i>Temperature Limit</i> field.
<i>ETHx Disconnected</i>	Triggered when the link on the corresponding Ethernet port is lost.
<i>Test Triggered</i>	A virtual event designed specifically for testing your configured actions (e.g., to verify that an SMS or email is sent correctly). <b>Note:</b> Before testing, you must ensure that the event system is enabled, the desired actions are configured, and all settings are saved. The test can then be triggered manually by clicking on the event name itself, which acts as a hyperlink in the web interface.
<i>Application 1/2</i>	Custom events that can be triggered by user scripts or applications (IDs 101 and 102).

Table 92: Available events

Action	Description
<i>SNMP</i>	Sends an SNMP trap to the defined SNMP manager.
<i>Syslog</i>	Writes a message to the system log.
<i>SMS Group 1/2</i>	Sends an SMS to all numbers in the specified SMS group.
<i>E-mail Group 1-4</i>	Sends an email to all addresses in the specified E-mail group.
<i>Script 1/2</i>	Executes the user script located at the specified path.

Table 93: Available actions

## Action Definitions

This section is where you define the details for each action.

Item	Description
<i>SMS Group 1/2</i>	A comma-separated list of phone numbers for the respective SMS action group.
<i>E-mail Group 1-4</i>	A comma-separated list of email addresses for the respective E-mail action group.
<i>Script Path 1/2</i>	The absolute path to the user script to be executed for the respective script action (e.g., <code>/var/scripts/my_script.sh</code> ).
<i>Temperature Limit</i>	The temperature threshold in degrees Celsius (°C) for the <i>Temperature Reached</i> event.

Table 94: Action definitions

## SNMP Settings

This section contains the specific settings for the *SNMP* trap action.

Item	Description
<i>SNMP Manager IPv4 Address</i>	The IP address of the server that will receive the SNMP traps.
<i>SNMP Manager Port</i>	The UDP port on which the SNMP manager is listening. The default is 162.
<i>SNMP Version</i>	The version of the SNMP protocol to use. Version 3 is recommended for enhanced security.
<i>PDU Type</i>	The type of Protocol Data Unit to send. <i>Inform</i> requires an acknowledgment from the manager, while <i>Trap</i> does not.
<i>Community</i>	For SNMPv2c only. A password-like credential used to authenticate communications. This string must exactly match the community string configured on the SNMP manager.
<i>Engine ID Payload Type</i>	Determines the source for generating the Engine ID. Options include the <i>ETH0 MAC address</i> , a custom <i>ASCII Text</i> string, or a custom <i>Hexadecimal Value</i> .
<i>Engine ID Payload</i>	If the Payload Type is set to ASCII or Hexadecimal, this field allows you to enter the custom value to be used for the Engine ID.
<i>Engine ID</i>	The final, unique identifier for the SNMP engine on this device, generated based on the settings above. This field is read-only.
<i>Context Name</i>	An identifier used to group related SNMP data, allowing for different logical subsets of managed objects.
<i>Username</i>	The username for SNMPv3 authentication.
<i>Authentication</i>	The hashing algorithm used for SNMPv3 message authentication (e.g., SHA-512).
<i>Authentication Password</i>	The password for SNMPv3 authentication.
<i>Privacy</i>	The encryption algorithm used for SNMPv3 message privacy (e.g., AES).
<i>Privacy Password</i>	The password for SNMPv3 privacy.

Table 95: SNMP settings for events

## 3.22 Scripts

The router provides several hooks for executing custom shell scripts in response to system and network events. This powerful feature allows for a high degree of automation and customization. The available script types are:

- **Startup Script:** Executed once every time the router boots up.
- **Up/Down IPv4 Scripts:** Executed when the primary IPv4 WAN connection is established or lost.
- **Up/Down IPv6 Scripts:** Executed when the primary IPv6 WAN connection is established or lost.

For detailed information about available commands, refer to the [Command Line Interface](#) Application Note. For broader guidance on customization, see the [Extending Router Functionality](#) Application Note.

### 3.22.1 Startup

The *Startup Script* is ideal for tasks that need to run once at boot, such as initializing custom services, performing configuration checks, or launching background monitoring processes. The script is entered into the text area on the *Configuration* → *Scripts* page and saved by clicking the *Apply* button.

#### Warning

Changes to the startup script only take effect after the router is rebooted.

#### Example

The following script sends an SMS message upon router startup.

```
#!/bin/sh

# Define variables
PhoneNumber="+420123456789"
Message="Router has successfully started up."

# Send the SMS
sms "$PhoneNumber" "$Message"

exit 0
```

### 3.22.2 Up/Down IPv4

The *Up/Down IPv4* page allows you to define scripts that are triggered by changes in the primary WAN IPv4 connection state. The "Up" script runs when the IPv4 connection is established, and the "Down" script runs when it is lost. Because the router has a dual-stack implementation, scripts for IPv4 and IPv6 are configured and triggered independently.

These scripts are passed several arguments that provide context about the connection, such as the interface name and assigned IP address. This allows for dynamic actions based on the current network status.

### 3.22.3 Up/Down IPv6

The *Up/Down IPv6* page serves a purpose similar to that of the IPv4 page, but it is specifically intended for IPv6 connections.

#### Example

This example uses the IPv6 Up/Down scripts to send an email notification whenever the IPv6 WAN connection status changes. The *SMTP* service must be configured beforehand.

Figure 101: IPv6 up/down script configuration page

#### Up Script:

```
email -t name@domain.com -s "Router Alert" -m "IPv6 WAN connection is UP."
```

#### Down Script:

```
email -t name@domain.com -s "Router Alert" -m "IPv6 WAN connection is DOWN."
```

#### Warning

After saving an Up/Down script, the router must be rebooted for the changes to become active.

## 3.23 Scripts

The router provides several hooks for executing custom shell scripts in response to system and network events. This powerful feature allows for a high degree of automation and customization. The available script types are:

- **Startup Script:** Executed once every time the router boots up.
- **Up/Down IPv4 Scripts:** Executed when the primary IPv4 WAN connection is established or lost.
- **Up/Down IPv6 Scripts:** Executed when the primary IPv6 WAN connection is established or lost.

For detailed information about available commands, refer to the [Command Line Interface](#) Application Note. For broader guidance on customization, see the [Extending Router Functionality](#) Application Note.

### 3.23.1 Startup

The *Startup Script* is ideal for tasks that need to run once at boot, such as initializing custom services, performing configuration checks, or launching background monitoring processes. The script is entered into the text area on the *Configuration* → *Scripts* page and saved by clicking the *Apply* button.

#### Warning

Changes to the startup script only take effect after the router is rebooted.

#### Example

The following script sends an SMS message upon router startup.

```
#!/bin/sh

# Define variables
PhoneNumber="+420123456789"
Message="Router has successfully started up."

# Send the SMS
sms "$PhoneNumber" "$Message"

exit 0
```

### 3.23.2 Up/Down IPv4

The *Up/Down IPv4* page allows you to define scripts that are triggered by changes in the primary WAN IPv4 connection state. The "Up" script runs when the IPv4 connection is established, and the "Down" script runs when it is lost. Because the router has a dual-stack implementation, scripts for IPv4 and IPv6 are configured and triggered independently.

These scripts are passed several arguments that provide context about the connection, such as the interface name and assigned IP address. This allows for dynamic actions based on the current network status.

### 3.23.3 Up/Down IPv6

The *Up/Down IPv6* page serves a purpose similar to that of the IPv4 page, but it is specifically intended for IPv6 connections.

#### Example

This example uses the IPv6 Up/Down scripts to send an email notification whenever the IPv6 WAN connection status changes. The *SMTP* service must be configured beforehand.

**IPv6 Up/Down Script**

**Up Script**

```
#!/bin/sh
#
# This script will be executed when PPP/WAN IPv6 connection is established.

email -t name@domain.com -s "Router Alert" -m "IPv6 WAN connection is UP."
```

**Down Script**

```
#!/bin/sh
#
# This script will be executed when PPP/WAN IPv6 connection is lost.

email -t name@domain.com -s "Router Alert" -m "IPv6 WAN connection is DOWN."
```

Figure 102: IPv6 up/down script configuration page

#### Up Script:

```
email -t name@domain.com -s "Router Alert" -m "IPv6 WAN connection is UP."
```

#### Down Script:

```
email -t name@domain.com -s "Router Alert" -m "IPv6 WAN connection is DOWN."
```

#### Warning

After saving an Up/Down script, the router must be rebooted for the changes to become active.

### 3.24 Quick Setup

The *Quick Setup* page provides a streamlined, single-page interface that gathers all of the most critical settings for the initial configuration of the router. This page is automatically displayed upon the first login to a new or factory-reset device, but it can also be accessed manually at any time via the *Configuration* → *Quick Setup* menu.

This wizard conveniently consolidates essential settings from various sections of the web interface, allowing you to configure time, LAN, and mobile network settings from a single page.

Quick Setup	
<input checked="" type="checkbox"/> Set current browser time once	
<input type="checkbox"/> Synchronize clock with cellular network	
<input type="checkbox"/> Synchronize clock with GNSS (and enable GNSS service)	
<input type="checkbox"/> Synchronize clock with remote NTP server	
Primary NTP Server	<input type="text"/>
Timezone	<input type="text" value="GMT+01:00"/>
Country	<input type="text" value="all countries"/> <i>APs are not allowed to operate in 5 GHz frequency band in world-wide mode.</i>
<input checked="" type="checkbox"/> Enable Port	
DHCP Client	<input type="text" value="disabled"/>
IP Address	<input type="text" value="192.168.1.1"/>
Subnet Mask	<input type="text" value="255.255.255.0"/>
<input checked="" type="checkbox"/> Enable dynamic DHCP leases	
IP Pool Start	<input type="text" value="192.168.1.2"/>
IP Pool End	<input type="text" value="192.168.1.254"/>
<input checked="" type="checkbox"/> Create connection to mobile network	
Carrier	<input type="text" value="Outside North America"/>
APN *	<input type="text"/> <i>leave blank for automatic selection</i>
SIM PIN *	<input type="text"/> <i>using wrong PIN will block your SIM</i>
<input checked="" type="checkbox"/> Enable WebAccess/DMP Client	
<i>This router is automatically connected to the Advantech cloud management platform WebAccess/DMP (learn more - <a href="#">link</a>). Decide whether you want to keep this connection to the WebAccess/DMP server located on the public Internet before continuing setup. You can change this setting anytime in the router's web interface (Customization &gt; WebAccess/DMP Client).</i>	
<input type="checkbox"/> Reset other settings to defaults and reboot	
* can be blank	
<input type="button" value="Apply"/>	

Figure 103: Quick Setup page

## Time and Region

For a complete overview of these settings, refer to Chapter [5.4 Set Date and Time](#), Chapter [3.18.5 NTP](#), and Chapter [3.6.3 Country](#).

Item	Description
<i>Set current browser time once</i>	A one-time action that sets the router's system time to match the time of your web browser.
<i>Synchronize clock with...</i>	Selects the method for automatic time synchronization. Note that synchronization via GNSS is only available on router models equipped with a GNSS module.
<i>Primary NTP Server</i>	The address of the NTP server to be used when <i>Synchronize clock with remote NTP server</i> is selected.
<i>Timezone</i>	Sets the local timezone for the router.
<i>Country</i>	For models equipped with Wi-Fi, this setting configures the regulatory domain. It is crucial to select the country of operation to ensure compliance with local radio frequency regulations, as this affects which Wi-Fi channels are available.

Table 96: Quick Setup: Time and Region

## LAN Port and DHCP Server

The full configuration options for the LAN interface are described in Chapter [3.1 Ethernet](#).

Item	Description
<i>Enable Port</i>	Enables or disables the primary LAN port (eth0).
<i>DHCP Client</i>	If enabled, the router's LAN port will request an IP address from another DHCP server on the network.
<i>IP Address</i>	The static IPv4 address assigned to the router's primary LAN interface.
<i>Subnet Mask</i>	The subnet mask for the primary LAN interface.
<i>Enable dynamic DHCP leases</i>	Enables the router's built-in DHCP server, which automatically assigns IPv4 addresses to client devices on the LAN.
<i>IP Pool Start</i>	The starting address of the IP range that the DHCP server will lease to clients.
<i>IP Pool End</i>	The ending address of the IP range that the DHCP server will lease to clients.

Table 97: Quick Setup: LAN Port and DHCP Server

## Mobile Network

### Info

This section is only available on cellular router models.

The complete configuration for the mobile network is available in Chapter [3.4 Mobile WAN](#).

Item	Description
<i>Create connection to mobile network</i>	When checked, the router will automatically attempt to connect to the mobile network after booting.
<i>Carrier</i>	Allows for the selection of a pre-defined profile for a specific mobile carrier (e.g., for North American operators).
<i>APN</i>	The Access Point Name for your mobile network data plan. In many cases, this can be left blank to allow for automatic selection by the carrier.
<i>SIM PIN</i>	The PIN for your SIM card. Entering an incorrect PIN multiple times may permanently block the SIM card.

Table 98: Quick Setup: Mobile Network

## System and Service Settings

Item	Description
<i>Enable WebAccess/DMP Client</i>	Enables or disables the client for the WebAccess/DMP remote management platform. For complete details, see Chapter <a href="#">1.2.2 Remote Management Platform</a> .
<i>Reset other settings to defaults and reboot</i>	If checked, any settings not present on this Quick Setup page will be reset to their factory defaults when the new configuration is applied.

Table 99: Quick Setup: System and Service Settings

# 4. Customization

## 4.1 Router Apps

Router Apps (RA), formerly known as User Modules, are custom software packages that extend the router's capabilities in areas such as security, advanced networking, and custom services.

A wide variety of Router Apps are available for free on the Advantech [Router Apps webpage](#).

### Info

- Users with the *Admin* role can install, manage, and view Router Apps. Users with the *User* role can only view the list of installed apps.
- To quickly check the operational state of all installed modules without entering their configuration, navigate to the *Status* → *Router Apps* page.

### Overview of the Router Apps Page

To manage apps, navigate to the *Customization* → *Router Apps* page. The page is divided into three main areas:

- **Installed Apps:** Lists all Router Apps currently installed on the device.
- **Manual Installation:** Allows for uploading and installing an app package from your computer.
- **Online Installation:** Allows for downloading and installing apps directly from a server.

The *Free Space* indicator shows how much storage is available for new applications.

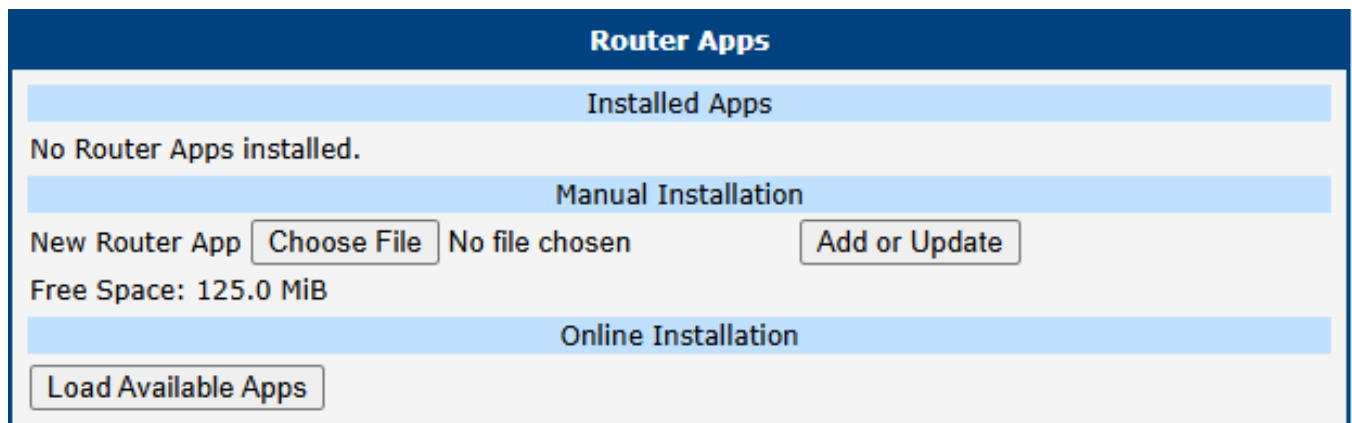

Figure 104: Default Router Apps page

### Installation and Management

#### Manual Installation

To install a Router App manually, click the *Choose File* button in the *Manual Installation* section to select the app package from your computer. The package must be a `*.tgz` file. Click the *Add or Update* button to begin the installation.

## Online Installation

To install apps from a server, first click the *Load Available Apps* button in the *Online Installation* section. This action fetches and displays a list of all applications available on the configured server.

- An active internet connection with functional DNS name resolution is required to perform this action. Without DNS, the router cannot find the server, which will result in a `Couldn't resolve host name` error.
- By default, the router is configured to use the public Advantech server. A custom server can be specified on the *Settings* page (see Chapter 4.2 *Settings*). Note that the *Load Available Apps* button is disabled if communication with the server is deactivated in the settings.
- The list of available apps is not stored permanently; it is cleared when the router reboots and must be reloaded. The timestamp of the last successful list update is shown next to the button.
- This online installation feature requires firmware version 6.4.0 or newer and is not available on v2 platform routers.

The screenshot displays the 'Router Apps' interface. At the top, there's a header 'Router Apps'. Below it, a section titled 'Installed Apps' shows 'Customer Logo v1.0.0 (2020-01-31)' with a 'Delete' button. The next section is 'Manual Installation', featuring a 'New Router App' field with a 'Choose File' button, 'No file chosen' text, and an 'Add or Update' button. Below this, it indicates 'Free Space: 708 MiB'. The 'Online Installation' section has a 'Reload Available Apps' button and shows the last check time as '2024-01-15 10:39:55'. A list of available apps follows, each with a version dropdown and an 'Install' button. The apps listed are: 802.1X Authenticator (1.1.0), Azure IoT SDK Python (1.0.0), Customer Logo (1.1.0), Unique Password (1.0.2), WebAccess/VPN Client (1.1.3), WiFi STA Relay (1.3.0), and Zabbix Agent (5.0.3-1). Each app entry includes a brief description of its function.

App Name	Current Version	Available Version	Action	Description
802.1X Authenticator	1.1.0	1.1.0	Install	802.1X network authentication standard for devices on LAN/WLAN.
Azure IoT SDK Python	1.0.0	1.0.0	Install	Add Microsoft Azure IoT Hub Device SDK for Python to router [Obsolete version].
Customer Logo	v1.0.0	1.1.0	Install	Allow users to change the logo displayed in the header of the web interface
Unique Password	1.0.2	1.0.2	Install	unique. From January 2020, this is required by California Senate Bill No. 327. The format used is 'Ph'
WebAccess/VPN Client	1.1.3	1.1.3	Install	This user module allows the router to be part of WebAccess/VPN.
WiFi STA Relay	1.3.0	1.3.0	Install	Set the router to transparent mode (WiFi interface in client mode bridged to ETH). [Limited to specific router models]
Zabbix Agent	5.0.3-1	5.0.3-1	Install	Agent for Zabbix network monitoring platform.

Figure 105: Router Apps page with online apps loaded

## Managing Installed Apps

All installed apps are listed in the *Installed Apps* section.

- **Accessing an App GUI:** If an app has a web interface, its name will be a clickable link that opens the app's GUI.
- **Removing an App:** To uninstall an app, click the corresponding *Delete* button.

### Info

For information on creating your own Router Apps, please refer to the *Extending Router Functionality* Application Note [2].

## 4.2 Settings

To configure the server connection for online installation, navigate to *Customization* → *Router Apps* → *Settings*.

Figure 106: Router Apps server settings

Item	Description
<i>Disable server communication</i>	Check this to disable all communication with the online app server.
<i>Use public server</i>	The default option. Uses the official Advantech server to download Router Apps. Requires an active internet connection.
<i>Use custom server</i>	Connect to a private, self-hosted server. <b>This requires an on-premises installation of Advantech's <i>WebAccess/DMP</i> software.</b>
<i>API URL</i>	The URL of your custom server. Must begin with <code>https://</code> .
<i>CA certificate</i>	Upload a CA certificate for your custom server if it uses a private or non-standard Certificate Authority.

Table 100: Router Apps server settings descriptions

# 5. Administration

## 5.1 Manage Users

This chapter provides a comprehensive guide to user management on the router. It explains the differences between user roles and details how to create, modify, and delete accounts. Additionally, it covers the configuration of advanced security features such as Two-Factor Authentication (2FA) and passwordless SSH login.

The primary administration page is *Administration* → *Manage Users*, which is fully accessible to users with the *Admin* role. Users with the standard *User* role have restricted access and can only modify their own settings via the separate *Administration* → *Modify User* page; refer to Chapter 5.2 *Modify User*.

### 5.1.1 Managing User Accounts

#### Warning



Be careful not to lock out or delete all users with the *Admin* role. If this happens, no user will have the necessary permissions to manage accounts, and a factory reset may be required.

#### Info



- The main *Manage Users* page is only accessible to users with the *Admin* role.
- For global authentication settings, such as enabling 2FA services and setting password complexity rules, see Chapter 3.20.1 *Authentication*.

The *Manage Users* page is the central hub for creating, modifying, and deleting user accounts on the router. In Figure 107, you can see that there are two existing users, `root` and `Alice`, and we are about to add a new user named `John` with the *Admin* role.

Manage Users	
root	Admin <input type="button" value="Lock"/> <input type="button" value="Modify"/>
Alice	User <input type="button" value="Lock"/> <input type="button" value="Modify"/> <input type="button" value="Delete"/>
Role	<input type="text" value="Admin"/>
Username	<input type="text" value="John"/>
New Password	<input type="password" value="....."/> <input type="button" value="eye"/>
Confirm Password	<input type="password" value="....."/> <input type="button" value="eye"/>
SSH Public Key *	<input type="text" value="ssh-rsa AAAAB3NzaC1yc2EAAAADAQABAAQCMNgYZU504EkVocFQZJJDbmUwe4WbcCIe3 aXaEtz 1VsdJN 97vKRA"/> <input type="button" value="Load From File..."/>
Phone Number *	<input type="text" value="+15551234567"/>
Email Address *	<input type="text" value="address@email.com"/>
<input type="button" value="Add User"/>	

Figure 107: Manage Users configuration page

## User Roles and Permissions

The router supports two primary user roles, each with a different level of permissions:

- **User Role:** Intended for basic monitoring. Users with this role have read-only access to most of the web interface and cannot make configuration changes (except for modifying their own account). Console access is disabled.
- **Admin Role:** Intended for full device management. Administrators have full read-write access to the entire web interface and can log in via the console. However, this is not equivalent to the root superuser on a standard Linux system.



### Info

In addition to the primary roles, the system includes a highly restricted **Operator Role**. Users with this role can only log in and change their own password, with no other capabilities or access to the web interface. This role is intended solely for special-purpose Router Apps and future high-granularity access rights configurations.

### 5.1.2 Adding, Modifying, and Deleting Users

The main part of the page lists all existing users. For each user, you have three available actions:

Button	Description
Lock	Temporarily disables the user account, preventing login via both the web interface and the console.
Modify	Opens the <i>Modify User</i> page, allowing you to change the password, update contact information, or manage security settings like the SSH public key and 2FA; refer to Chapter 5.2 <i>Modify User</i> .
Delete	Permanently removes the user account from the router.

Table 101: User action buttons

To create a new account, fill out the form, as shown in Figure 107 for a new user `John`, and click the *Add User* button.

Item	Description
<i>Role</i>	Assigns the user role. Available options are <i>Admin</i> , <i>User</i> , and the highly restricted <i>Operator</i> role.
<i>Username</i>	The name for the new user account.
<i>New Password</i>	<p>Sets the password for the user. It must always comply with the rules defined by the <i>Force Password Complexity</i> setting (see Chapter 3.20.1 <i>Authentication</i>).</p> <p>When changing a password for an existing user, the new password is checked against the most recent old password and must meet the following <b>additional requirements</b>:</p> <ul style="list-style-type: none"> <li>• <b>Character Difference:</b> The new password must differ from the old one by a minimum number of characters:                             <ul style="list-style-type: none"> <li>◦ At least <b>1</b> new or different character for the <i>Very Weak</i> and <i>Weak</i> levels.</li> <li>◦ At least <b>5</b> new or different characters for the <i>Good</i> and <i>Strong</i> levels.</li> </ul> </li> <li>• <b>No Trivial Variations:</b> The new password cannot be a simple variation of the old one. Specifically, the following are not allowed:                             <ul style="list-style-type: none"> <li>◦ Changing only the case of letters.</li> <li>◦ Cyclically shifting the characters.</li> </ul> </li> </ul>

Table 102: New user parameters

Item	Description
<i>Confirm Password</i>	Re-enter the new password to confirm it. This helps prevent typos.
<i>SSH Public Key</i>	Paste a public SSH key here to enable passwordless console login for this user. The maximum supported size is 16 KiB. See <a href="#">for a detailed guide</a> .
<i>Phone Number</i>	The user's mobile phone number. If provided, an SMS notification will be sent to this number whenever the user's password is changed. <b>Note:</b> This feature is only available on cellular router models.
<i>Email Address</i>	The user's email address. If provided, an email notification will be sent to this address whenever the user's password is changed. <b>Note:</b> This feature requires a functional SMTP server configuration, as detailed in Chapter <a href="#">3.18.6 SMTP</a> .

Table 102: New user parameters (continued)

### 5.1.3 Two-Factor Authentication (2FA)

Two-Factor Authentication adds a critical layer of security by requiring a time-sensitive verification code from an authenticator app in addition to a password.

#### Important

- **Correct Time is Crucial:** 2FA is time-based. Ensure the router's clock is always accurate by enabling the NTP client. See Chapter [3.18.5 NTP](#).
- **Risk of Lockout:** An incorrect 2FA setup can lock you out of your account. It is highly recommended to have a separate admin account without 2FA as a backup during the setup process.
- **Secret Key is Vital:** Without the secret key, you cannot complete the setup or log in. A user with the *Admin* role cannot retrieve a secret key for another user; they can only delete it.
- **Secret Key Deletion:** If a user is unable to log in using 2FA for any reason, a user with the *Admin* role can delete their *Secret Key*, thereby disabling 2FA login for that user.

#### Configuration Steps

1. **Enable 2FA Service Globally:** Go to *Configuration* → *System* → *Authentication* and enable either *Google Authenticator* or *OATH* as the 2FA login service; refer to Chapter [3.20.1 Authentication](#). This selects the type of 2FA service, which is common for all users on the router. However, for 2FA login to be applied to a specific user, that user must set up their *Secret Key* as described in the next step.
2. **Generate and Save Secret Key:** The *Secret Key* must be configured by each user individually after logging in to the router. A user with the *Admin* role can only delete another user's *Secret Key* but cannot generate or edit it. On the *Modify User* page, in the *Two-Factor Auth* section, select *Generate a new secret key*, click the *Apply* button, and the key will be generated. You can also upload a key from a file containing the pure text of the key. Ensure the key length is sufficient (for example, 26 characters) and do not forget to click the *Apply* button once the key file is chosen.
3. **Link to Authenticator App:** Open your authenticator app (e.g., *Google Authenticator*, *Authy*) and add a new account by scanning the QR code shown in the *Two-Factor Auth* section or by manually inputting the secret code, which can be revealed by clicking the *Show* button.

#### Login Procedure

With 2FA enabled, the login process has an extra step:

- **Web Interface:** After entering your username and password, you will be prompted for a *Verification Code*. Open your authenticator app to get the current code and enter it to complete the login.
- **Console Access:** The console will prompt you for your username, password, and verification code sequentially.

### 5.1.4 Passwordless Console Login via SSH Key

This method allows you to log in to the router’s SSH console using a cryptographic key pair instead of a password. The following guide uses the PuTTY client for Windows.

#### Prerequisites

From the official [PuTTY download page](#), download `putty.exe` (the terminal client), `puttygen.exe` (the key generator), and `pageant.exe` (an authentication agent).

#### Generating the Key Pair

1. Run `puttygen.exe`.
2. Ensure *RSA* is selected as the key type and click *Generate*.
3. Move your mouse randomly over the blank area to generate randomness for the key.
4. Once complete, click *Save public key* and *Save private key*. Save them to a secure location on your computer. Do not use a passphrase for simplicity in this guide.
5. Keep the PuTTY Key Generator window open.

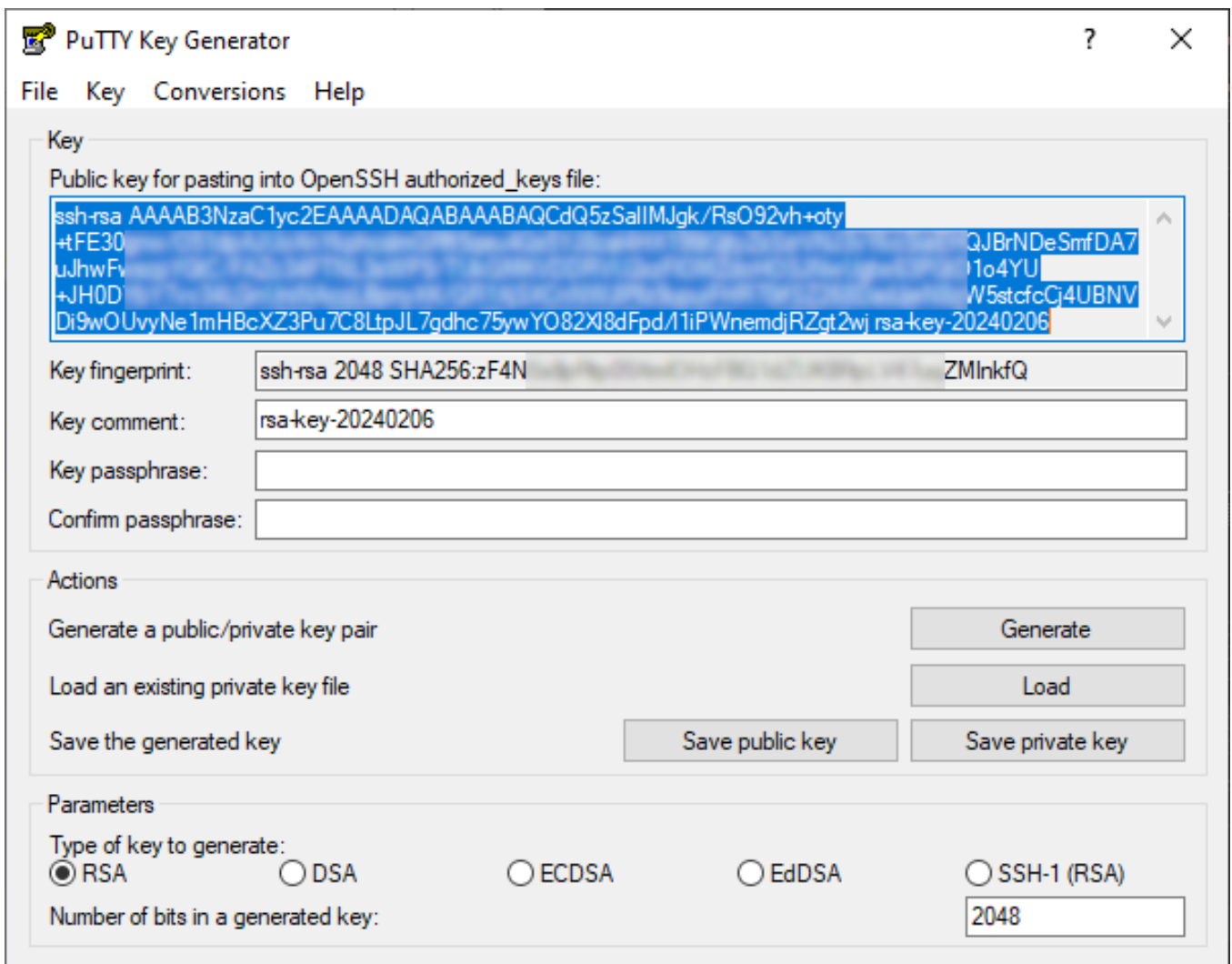

Figure 108: Generating an RSA key pair with PuTTYgen

### Uploading the Public Key to the Router

1. In the PuTTY Key Generator window, copy the entire text from the box labeled *Public key for pasting into OpenSSH authorized\_keys file*.
2. In the router's web interface, navigate to *Administration* → *Manage Users* and click *Modify* for the desired *Admin*-level user.
3. Paste the copied key into the *SSH Public key* field and click *Apply*.

#### Warning

The key must be in the correct one-line format, typically starting with `ssh-rsa`. Copying the key directly from the `.pub` file may not work. It is safest to copy it from the PuTTYgen window.

### Configuring the PuTTY Session

1. Run `putty.exe`.
2. In the *Session* category, enter the router's IP address.
3. Navigate to *Connection* → *Data* and enter the username in the *Auto-login username* field.
4. Navigate to *Connection* → *SSH* → *Auth* → *Credentials* and browse for your saved private key file.
5. Return to the *Session* category, give the session a name, and click *Save*.

To connect, simply load the saved session and click *Open*. You will be logged in automatically without a password prompt.

### 5.1.5 Forced Password Change

In certain situations, the router will require a user to change their password immediately upon the next login. This occurs:

- When logging in for the very first time after a factory reset.
- When a user's password has expired (configured in *Authentication* settings).
- When an administrator has manually changed another user's password.

The new password must adhere to the complexity requirements configured on the *Configuration* → *System* → *Authentication* page.

**New Password**

Password for user Alice has expired.  
You cannot continue until you set a new one.

New Password

Confirm Password

- Must be at least 6 characters long
- Must not be palindrome
- Must not contain username
- Must be at least 1 character different from the old password
- Must not be a rotated old password
- Must not be an old password with case changes only

Figure 109: Forced password change prompt

## 5.2 Modify User



### Info

The *Administration* → *Modify User* page is only accessible to users with the *User* role.

The *Administration* → *Modify User* page allows users to edit their own configuration settings. While a standard user is restricted to this page, a user with the *Admin* role can modify all user accounts via the *Administration* → *Manage Users* page, as described in Chapter 5.1 *Manage Users*.

Figure 110 shows an example of the *Administration* → *Modify User* configuration page, illustrating a case where a user with the *User* role is logged in to the router and does not have access to the *Administration* → *Manage Users* configuration page.

**Modify User**

Username

Current Password

New Password

Confirm Password

- Must be at least 6 characters long
- Must not be palindrome
- Must not contain username
- Must be at least 1 character different from the old password
- Must not be a rotated old password
- Must not be an old password with case changes only

SSH Public Key \*

Phone Number \*

Email Address \*

Two-Factor Auth  (TFA is enabled/disabled via System/Authentication)

Secret Key

Keep the current secret key

Delete the secret key

Generate a new secret key

Upload a new secret key

Secret Key File  No file chosen

Figure 110: Modify User configuration page

Most items in Figure 110 are already described in Chapter 5.1 *Manage Users*. If the user wants to change their password, they must enter their original password into the *Current Password* field. The *SSH Public Key* field is disabled here because users with the *User* role are not permitted to log in via the console. In addition to the password, the user can also change their phone number and email address. In the last section of the screen, the user can modify their Two-Factor Authentication settings; for details, see Chapter .

### 5.3 Change Profile

Advantech routers allow you to store up to four complete sets of configurations, known as profiles: one *Standard Profile* and three *Alternative Profiles* (alt1, alt2, alt3). This feature is particularly useful for switching between different operational modes, such as changing mobile provider settings, activating different VPN tunnels, or modifying firewall rules based on location or time.

Figure 111: Change profile page

#### Managing Profiles

The *Administration* → *Change Profile* page serves two main purposes: saving the router’s current running configuration into a specific profile, and switching the router to use a different profile.

Item	Description
<i>Profile</i>	Chooses the configuration profile that the router will load and use after the next reboot.
<i>Copy settings from current profile to selected profile</i>	When this box is checked, clicking <i>Apply</i> will save the router’s <b>current running configuration</b> into the profile selected in the dropdown menu above. The router will <b>not</b> switch to this profile; it only saves the settings.

Table 103: Profile management options

#### Warning



Any change made on this page, whether switching a profile or saving one, takes effect only after the router is rebooted.

#### Methods for Switching Profiles

You can switch the active profile using several methods:

- **Web Interface:** Select the desired profile from the *Select profile to switch to* dropdown and click *Apply*. Then, reboot the router.
- **SMS Command:** Send an SMS with the text `set profile [std|alt1|alt2|alt3]` to the router. This change is permanent and will be used after the next reboot. This is configured on the *Configuration* → *Sevices* → *SMS* page.

## 5.4 Set Date and Time

### Warning



This page is for a **one-time manual setting** of the router’s clock. For continuous time synchronization, you must configure the NTP client. See Chapter [3.18.5 NTP](#) for details.

### Info



Please note that some of the options described below may not be available on all router models.

This page offers several methods for setting the system date and time.

Set Date and Time	
<input checked="" type="radio"/>	Set current browser time
<input type="radio"/>	Set specific date / time
Date	<input type="text" value="2025 - 12 - 16"/>
Time	<input type="text" value="11 : 33 : 17"/>
<input type="radio"/>	Query cellular module
<input type="radio"/>	Query GNSS module
<input type="radio"/>	Query NTP server
NTP Server Address	<input type="text" value="pool.ntp.org"/>
<input type="button" value="Apply"/>	

Figure 112: Set date and time page

1. **Set current browser time:** Synchronizes the router’s clock with the time on your computer.
2. **Set specific date/time:** Allows you to manually enter a specific date and time. Use the format yyyy-mm-dd for the date and HH:MM:SS for the time.
3. **Query cellular module:** Retrieves the time from the mobile network using the NITZ standard. This requires an active cellular connection and support from both the mobile operator and the router’s cellular module.
4. **Query GNSS module:** On routers equipped with a GNSS module, this option sets the time based on satellite data. The GNSS receiver must be enabled and have a valid position fix.
5. **Query NTP server:** Performs a one-time synchronization with a specified NTP server. You can enter the server’s IP address (IPv4 or IPv6) or its domain name.

## 5.5 Manage SIM

The *Administration* → *Manage SIM* menu provides tools for managing the security and settings of your SIM cards.

### 5.5.1 Unlock SIM

If your SIM card is protected by a Personal Identification Number (PIN), you must first enter it on the *Mobile WAN* configuration page to establish a connection. This page, however, allows you to permanently remove the PIN protection from the SIM card so it will no longer be required upon startup.

To remove the PIN, navigate to *Administration* → *Manage SIM* → *Unlock SIM*. The page displays the *SIM Card* (1st or 2nd) that is currently active within the system, along with its unique IMSI number. This ensures you are unlocking the correct card. Note that this operation can only be performed on a SIM card that is currently detected by the system. To proceed, enter the correct 4–8 digit PIN into the *SIM PIN* field and click *Apply*.

#### Warning

The SIM card will be blocked after three incorrect PIN entry attempts. To unblock it, you will need the PUK code, as described in the next chapter.

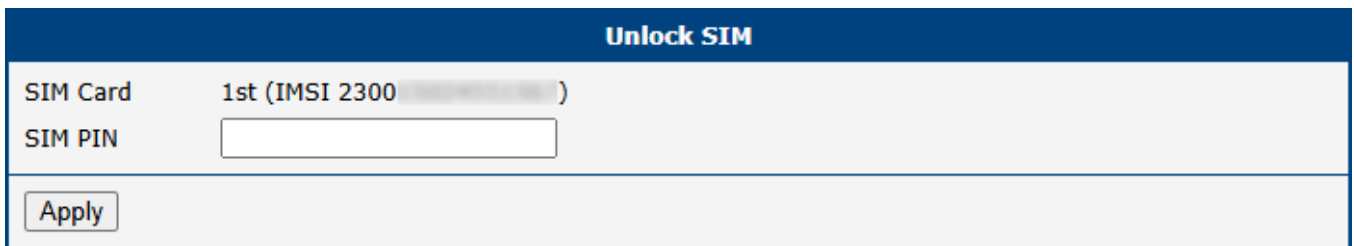

Unlock SIM	
SIM Card	1st (IMSI 2300 [redacted])
SIM PIN	<input type="text"/>
<input type="button" value="Apply"/>	

Figure 113: Unlock SIM page

### 5.5.2 Unblock SIM

This page allows you to unblock a SIM card that has been locked due to three incorrect PIN attempts. You can also use this page to set a new PIN by utilizing the PUK code.

To unblock the card, navigate to *Administration* → *Manage SIM* → *Unblock SIM*. The page displays the *SIM Card* (1st or 2nd) that is currently active within the system, along with its unique IMSI number. This ensures you are unblocking the correct card. Note that this operation can only be performed on a SIM card that is currently detected by the system.

To proceed, enter the PUK (Personal Unlocking Key) code provided by your carrier into the *SIM PUK* field, and specify your desired new PIN in the *New SIM PIN* field. Click *Apply* to confirm the changes.

#### Warning



The SIM card will be permanently blocked if the PUK code is entered incorrectly too many times (typically ten attempts).

Unblock SIM	
SIM Card	1st (IMSI 2300 )
SIM PUK	<input type="text"/>
New SIM PIN	<input type="text"/>
<input type="button" value="Apply"/>	

Figure 114: Unblock SIM page

### 5.5.3 Set SMS Center

This page allows you to manually set the phone number for the SMS Service Center (SMSC), which is essential for sending SMS messages from the router. To access this page, navigate to *Administration* → *Manage SIM* → *Set SMS Center*.

The currently configured SMSC number can be viewed at any time on the *Status* → *Mobile WAN* page (see Chapter 2.2 *Mobile WAN*).

#### Info

In most cases, the SMSC number is automatically provisioned by the SIM card, and you do not need to change this setting. You should only set this value manually if you are experiencing issues sending SMS messages and your mobile network operator has provided a specific number to use. The number can be entered in a local format or with a full international prefix (e.g., +420123456789).

Set SMS Center	
SIM Card	1st (IMSI 2300 )
Current Value	+420
Service Center Address	<input type="text"/>
<input type="button" value="Apply"/>	

Figure 115: Set SMS service center page

### 5.5.4 Switch SIM

The *Switch SIM* page allows for manual switching between SIM cards. This is primarily used for maintenance or testing purposes to force the router to a specific SIM slot, bypassing the automatic selection logic temporarily.

#### Info

To enable manual SIM switching, you must first deactivate the mobile connection. Navigate to *Configuration* → *Mobile WAN* and uncheck the *Create connection to mobile network* checkbox. If this is not done, the *SIM Card* selection will be disabled with a message "Disable connection to mobile network first" displayed.

To switch the active SIM card, navigate to *Administration* → *Manage SIM* → *Switch SIM*.

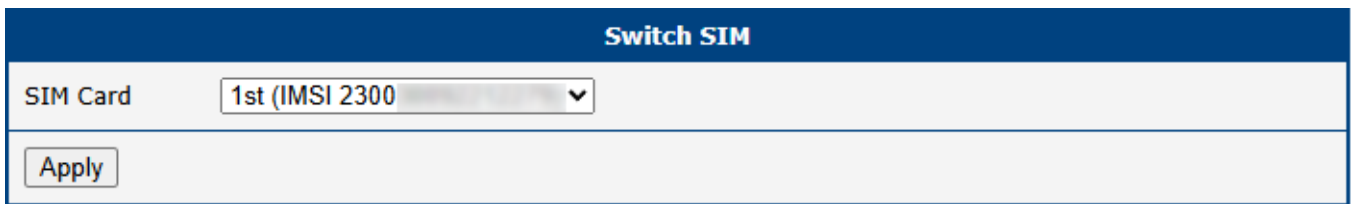

Switch SIM	
SIM Card	1st (IMSI 2300) ▼
<input type="button" value="Apply"/>	

Figure 116: Switch SIM page

Select the desired SIM card from the *SIM Card* drop-down list and click *Apply*. Each option includes the slot number and the IMSI number for precise identification.

#### Warning

The manual selection made on this page is temporary. Once you re-enable the mobile connection in *Configuration* → *Mobile WAN*, the router will automatically select the active SIM card based on the rules and priorities defined in the *Mobile WAN* configuration, potentially overriding your manual selection.

## 5.6 Send SMS

You can send an SMS message directly from the router to test cellular functionality or send a quick notification. To do so, use the *Send SMS* dialog in the *Administration* menu.

Enter the recipient's *Phone number*, type your message in the *Message* field, and click *Send*. By default, the router limits SMS messages to 160 characters. To send longer messages, you must install the [PDU SMS Router App](#).

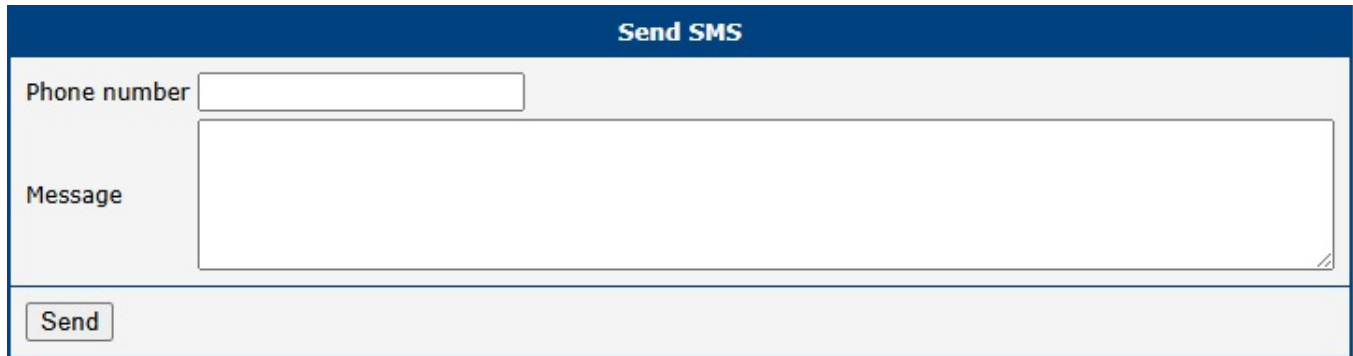

The image shows a web-based dialog box titled "Send SMS". It features a dark blue header bar with the text "Send SMS" in white. Below the header, the dialog is divided into two main sections. The first section is labeled "Phone number" and contains a single-line text input field. The second section is labeled "Message" and contains a large, multi-line text area for entering the message content. At the bottom left of the dialog, there is a button labeled "Send".

Figure 117: Send SMS dialog

It is also possible to send SMS messages programmatically via a CGI script. For detailed instructions, please refer to the [Command Line Interface](#) application note.

## 5.7 Backup Configuration

The *Administration* → *Backup Configuration* page allows you to save the router's current configuration settings to a file. This backup file can be used later to restore the router to a previous state or to clone the configuration to other devices.

Figure 118: Backup configuration page

Item	Description
<i>Backup Configuration</i>	When checked, the backup will include all router configuration settings.
<i>Backup Users</i>	When checked, the backup will include all user accounts and their passwords.
<i>Encryption Password</i>	If you set a password here, the backup file will be encrypted. If left blank, the file will be saved unencrypted.

Table 104: Backup configuration items

### Warning

Configuration backups can contain sensitive information, including user credentials. It is **strongly recommended** to always set an encryption password to protect the backup file. Also, ensure you are downloading the backup file over a secure (HTTPS) connection.

After selecting the desired options, click the *Apply* button. Your web browser will then prompt you to save the configuration file (with a `.cfg` extension). For instructions on how to use this file, see Chapter [5.8 Restore Configuration](#).

## 5.8 Restore Configuration

The *Restore Configuration* menu contains options for reverting the router’s settings to a previous state or resetting them entirely. It is divided into two sub-menus: *Restore from File* and *Factory Reset*.

### 5.8.1 Restore from File

This page allows you to restore the router’s settings from a previously created backup file. For instructions on creating a backup, please see Chapter 5.7 *Backup Configuration*.

To restore a configuration, navigate to *Administration* → *Restore Configuration* → *Restore from File*. Click the *Choose File* button to select the .cfg backup file from your computer. If the file is encrypted, you must provide the correct password in the *Decryption Password* field. Clicking the *Apply* button will upload the file, apply the settings, and reboot the router.

Figure 119: Restore from file page

#### Warning



Restoring a configuration from firmware older than version 6.2.0 is not supported. While upgrading the firmware from an older version is possible, attempting to restore a configuration file from such versions will result in some settings being reset to their factory defaults.

Item	Description
<i>Configuration File</i>	Select the .cfg backup file from your local computer.
<i>Decryption Password</i>	The password required to decrypt an encrypted backup file. Leave blank if the file is not encrypted.

Table 105: Restore from file options

## 5.8.2 Factory Reset

### Warning

Factory reset is a destructive action that completely erases all configuration and restores the router to its original factory state. **This action is irreversible and should be used with extreme caution.**

Key consequences of performing a factory reset include:

- All custom configurations (including network, VPN, and firewall rules) will be permanently deleted.
- All user accounts will be erased, leaving only the default administrator account.
- The router's LAN IP address will revert to its factory default (typically `192.168.1.1`), which will likely disconnect you from the web interface.

This software reset is equivalent to a hardware factory reset using the **RST** button, as detailed in Chapter [1.3.2 Reset Procedures](#).

To reset the router to its default factory settings, navigate to *Administration* → *Restore Configuration* → *Factory Reset*.

Clicking the *Reset and Reboot* button will erase all custom configurations, apply the factory default settings, and automatically restart the device. The reboot process typically takes about 30 seconds to complete.

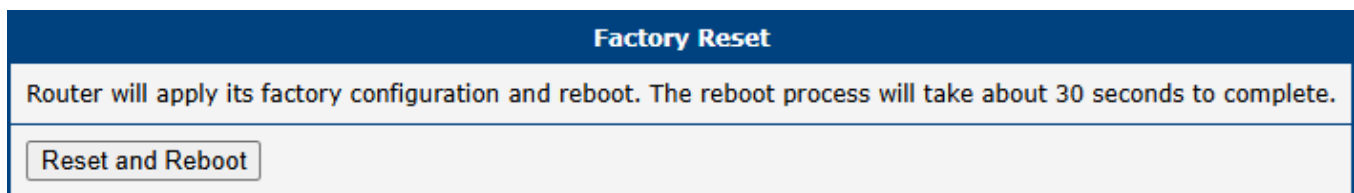

Figure 120: Factory reset page

## 5.9 Update Firmware

Keeping your router’s firmware up to date is crucial for security and access to the latest features. This page allows you to view the current firmware version and perform updates.

### Info



The latest official firmware for your router is always available on the Advantech Engineering Portal at [icr.advantech.com/download/routers-firmware](http://icr.advantech.com/download/routers-firmware).

### Warning



- For security reasons, always use the latest firmware version. Do not downgrade to a version older than the one the router was manufactured with, and never upload firmware designed for a different router model, as this can cause irreversible damage.
- Firmware updates can occasionally affect Router App compatibility. It is recommended to update all Router Apps at the same time as the firmware.
- If you are using an unsecured HTTP connection, some firewalls may block the firmware upload. In such cases, switch to HTTPS or contact your network administrator.

The *Administration* → *Update Firmware* page is divided into sections for viewing the current version and performing manual or online updates.

Update Firmware	
Firmware Version	: 6.3.9 (2023-01-04)
Firmware Name	: ICR-445x.bin
New Firmware	<input type="button" value="Choose File"/> No file chosen <input type="button" value="Update"/>
<input type="button" value="Check for updates"/>	Last check 2025-12-16 11:46:58
Newest FW online 6.5.4	

Figure 121: Update firmware administration page

Item	Description
<b>Current Version</b>	
<i>Firmware Version</i>	The version number and release date of the currently installed firmware.
<i>Firmware Name</i>	The name of the firmware file currently running on the router.
<b>Manual Update</b>	
<i>New Firmware</i>	Allows you to manually upload a firmware file from your computer using the <i>Choose File</i> button.
<i>Update</i>	Starts the update process using the selected file.
<b>Online Update</b>	
<i>Check for updates</i>	Connects to the public server to check if a newer firmware version is available. The timestamp of the last check is displayed.
<i>Download and Update</i>	This button appears if a newer version is found. Clicking it will automatically download the new firmware and initiate the update process.

Table 106: Update firmware page items

During the update, the router will display its progress, as shown in Figure 122. Once the update is finished, the router will automatically reboot. After it comes back online, click the provided *here* link to return to the web interface.

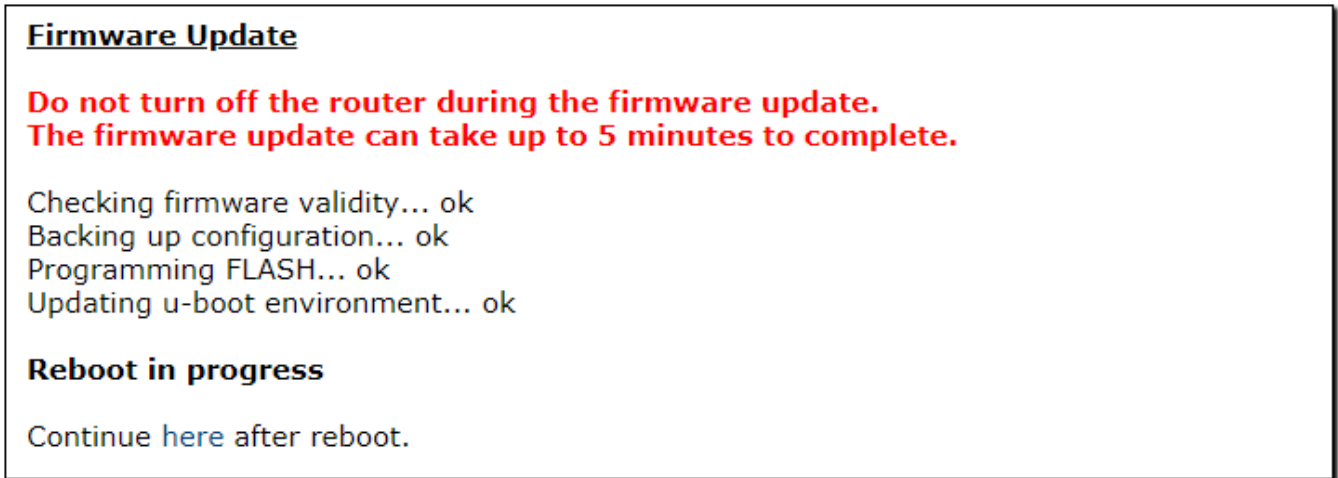

Figure 122: Firmware update in progress

## 5.10 Reboot

The *Reboot* menu provides two different options to restart or schedule automatic restarts of the router. To access these options, select the *Reboot* item in the *Administration* menu.

### Info

- Starting with firmware version 6.6.0, this functionality is integrated directly into the router's base firmware and replaces the legacy *Daily Reboot* Router App.
- To prevent conflicts, you must disable or uninstall the legacy Router App before using the integrated firmware feature.

### 5.10.1 Reboot Now

This submenu allows you to immediately reboot the router by clicking the *Reboot* button. A standard reboot takes approximately 30 seconds to complete.

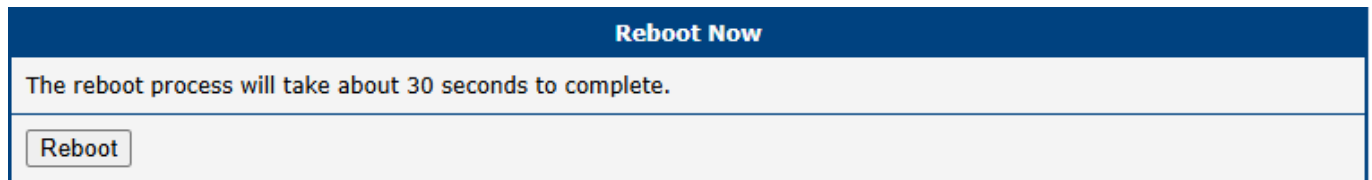

Figure 123: Reboot Now Submenu

### 5.10.2 Reboot Schedule

The *Reboot Schedule* submenu allows scheduled, automatic restarting of the router. The following parameters can be configured:

Item	Description
<i>Enable scheduled reboot</i>	Activates or deactivates periodic router restarts according to the selected schedule.
<i>Week Days</i>	Select specific days of the week (Monday–Sunday) for scheduled reboot. Multiple days can be selected.
<i>Time</i>	Set the exact time for the reboot to occur on chosen days (format: hh:mm).
<i>Minimum Uptime</i>	The minimum amount of time the router must be running before a scheduled reboot is permitted. This setting prevents reboot loops (e.g., during unstable power conditions). Range: 10–43,200 minutes.
<i>Maximum Uptime</i>	(Optional) Triggers an automatic reboot once the router’s continuous uptime reaches this specified value. This is often used to ensure long-term system stability. If left blank, no reboot is triggered based on maximum uptime (range: 10–43,200 minutes).

Table 107: Reboot schedule configuration items description

Reboot Schedule

Enable scheduled reboot  

Week Days

Mo	Tu	We	Th	Fr	Sa	Su
☑	☑	☑	☑	☑	☑	☑

Time

:  hh:mm

Minimum Uptime

min

10-43200 min

Maximum Uptime \*

min

10-43200 min

\* can be blank

Figure 124: Reboot schedule submenu

## 5.11 Logout

Clicking the *Logout* item in the main menu immediately terminates your session and logs you out of the router's web interface. You will be redirected to the login page.

### Info

 For security reasons, it is always recommended to log out when you have finished configuring the router, especially when accessing it from a shared or public computer.

# 6. Typical Use Cases

Advantech routers are highly versatile and support a wide range of applications. This chapter outlines several common deployment scenarios to illustrate the router’s key features and capabilities in practical, real-world examples.

The configuration examples provided in this chapter are based on IPv4 networks.

## 6.1 Access to the Internet from LAN

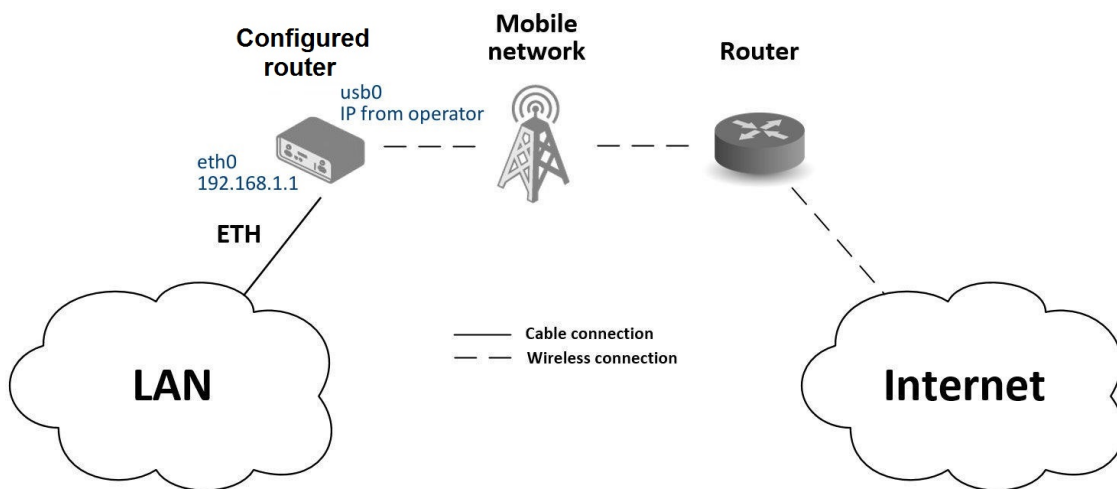

Figure 125: Access to the Internet from LAN – sample topology

In this example, a LAN connecting to the Internet via a mobile network, the SIM card with a data tariff has to be provided by the mobile network operator. This requires no initial configuration. You only need to place the SIM card in the *SIM1* slot (Primary SIM card), attach the antenna to the *ANT* connector and connect the computer (or switch and computers) to the router’s eth0 interface (LAN). Wait a moment after turning on the router. The router will connect to the mobile network and the Internet. This will be indicated by the LEDs on the front panel of the router (*WAN* and *DAT*).

Additional configuration can be done in the *LAN* and *Mobile WAN* items in the *Configuration* section of the web interface.

### LAN configuration

The factory default IP address of the router’s eth0 interface is in the form of 192.168.1.1. This can be changed (after login to the router) in the *LAN* item in the *Configuration* section. (See Figure 126.) In this case there is no need of any additional configuration. The DHCP server is also enabled by factory default (so the first connected computer will get the 192.168.1.2 IP address etc.). Other configuration options are described in the Chapter 3.1.

### Mobile WAN Configuration

Use the *Mobile WAN* item in the *Configuration* section to configure the connection to the mobile network, see Figure 127. In this case (depending on the SIM card) the configuration form can be blank. But make sure that *Create connection to mobile network* is checked (this is the factory default). For more details, see Chapter 3.4.

ETH0 Configuration		
	IPv4	IPv6
DHCP Client	disabled	disabled
IP Address	192.168.1.1	
Subnet Mask / Prefix	255.255.255.0	
Default Gateway		
DNS Server		
Bridged	no	
Media Type	auto-negotiation	
<input checked="" type="checkbox"/> Enable dynamic DHCP leases		
	IPv4	IPv6
IP Pool Start	192.168.1.2	
IP Pool End	192.168.1.254	
Lease Time	600	600 sec

Figure 126: Access to the Internet from LAN – Ethernet configuration

1st Mobile WAN Configuration		
	1st SIM card	2nd SIM card
<input checked="" type="checkbox"/> Create connection to mobile network		
APN *		
Username *		
Password *		
Authentication	PAP or CHAP	PAP or CHAP
IP Mode	IPv4	IPv4
IP Address *		
Dial Number *		
Operator *		
Network Type	automatic selection	automatic selection
PIN *		
MRU	1500	1500 bytes
MTU	1500	1500 bytes
DNS Settings	get from operator	get from operator

Figure 127: Access to the Internet from LAN – mobile WAN configuration

To check whether the connection is working properly, go to the *Mobile WAN* item in the *Status* section. You will see information about operator, signal strength etc. At the bottom, you should see the message: *Connection successfully established*. The *Network* item should display information about the newly created network interface, *usb0* (mobile connection). You should also see the IP address provided by the network operator, as well as the route table etc. The LAN now has Internet access.

## 6.2 Backup Access to the internet from LAN

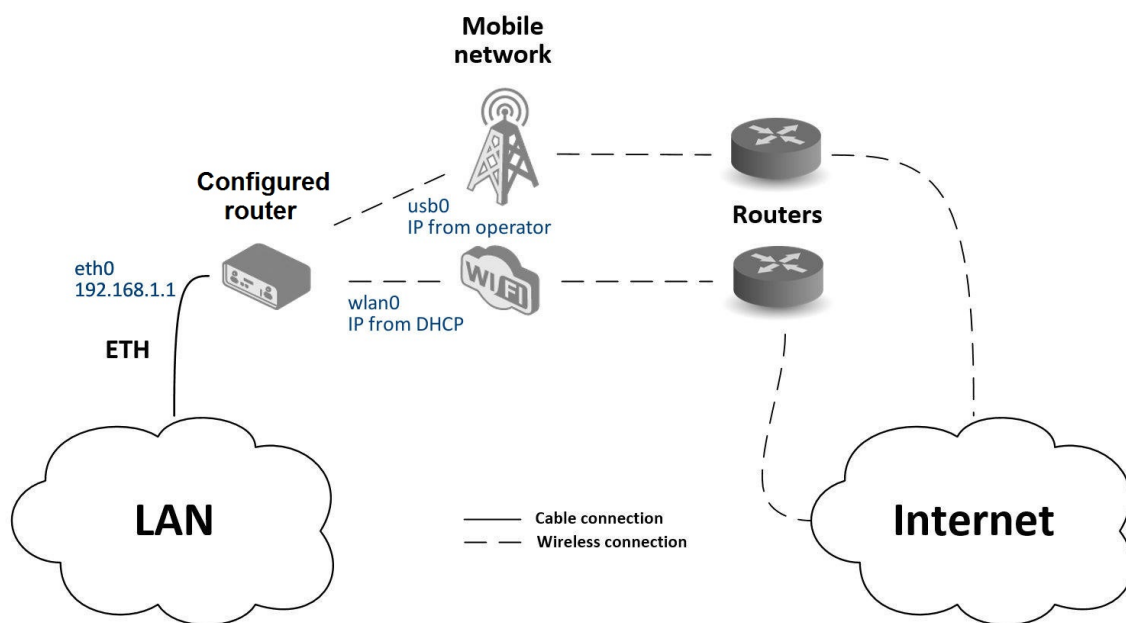

Figure 128: Backup access to the internet – sample topology

The configuration form on the *Backup Routes* page lets you back up the primary connection with alternative connections to the internet/mobile network. Each backup connection can be assigned a priority.

### LAN configuration

In the *LAN* item you can use the factory default configuration as in the previous situation. Changes will take effect after you click on the *Apply* button. Detailed Ethernet configuration is described in Chapter 3.1.

### WLAN configuration

To use the WLAN you will need to configure the WiFi station in the *WiFi - > Station* item, as shown in Figure 129. Check the *Enable WiFi STA*, enable the DHCP client and fill in the addresses of the default gateway and DNS server. Next, fill in the data for the connection (SSID, authentication, encryption, WPA PSK Type and password). For details see Chapter 3.6.2. Click the *Apply* button to confirm the changes.

To verify that the WiFi connection is successful, check the *WiFi* item in the *Status* section. If the connection is successful you should see the following message: *wpa\_state=COMPLETED*.

WiFi STA Configuration		
<input checked="" type="checkbox"/> Enable WiFi STA		
	IPv4	IPv6
DHCP Client	enabled	enabled
IP Address		
Subnet Mask / Prefix		
Default Gateway	192.168.3.1	
DNS Server	192.168.3.1	
SSID	WiFiNetwork	
Probe Hidden SSID	enabled	
Country Code *		
Authentication	WPA2-PSK	
Encryption	AES	
WEP Key Type	ASCII	
WEP Default Key	1	
WEP Key 1		
WEP Key 2		
WEP Key 3		
WEP Key 4		
WPA PSK Type	ASCII passphrase	
WPA PSK	WiFiPassword	

Figure 129: Backup access to the internet – WiFi configuration

### Mobile WAN configuration

To configure the mobile connection it should be sufficient to insert the SIM card into the *SIM1* slot and attach the antenna to the *ANT* connector. (Depending on the SIM card you are using).

To set up backup routes you will need to enable *Check Connection* in the *Mobile WAN* item. (See Figure 130.) Set the *Check connection* option to *enabled + bind* and fill in an IP address of the mobile operator's DNS server or any other reliably available server and enter the time interval of the check. For detailed configuration, see Chapter 3.4.

### Backup Routes configuration

After setting up the backup routes you will need to set their priorities. In Figure 131, the WiFi wlan0 connection has the highest priority. If that connection fails, the second choice will be the mobile connection – usb0 network interface.

The backup routes system must be activated by checking the *Enable backup routes switching* item for each of the routes. Click the *Apply* button to confirm the changes. For detailed configuration see Chapter 3.7.

You can verify the configured network interfaces in the *Status* section in the *Network* item. You will see the active network interfaces: eth0 (connection to LAN), wlan0 (WiFi connection to the internet) and usb0 (mobile connection to the internet). IP addresses and other data are included.

At the bottom of the page you will see the *Route Table* and corresponding changes if a WiFi connection is not available, the mobile connection will be used.

Backup routes work even if they are not activated in the *Backup Routes* item, but the router will use the factory defaults described in Chapter viz 3.7.

1st Mobile WAN Configuration			
<input checked="" type="checkbox"/> Create connection to mobile network			
	1st SIM card	2nd SIM card	
APN *	<input type="text"/>	<input type="text"/>	
Username *	<input type="text"/>	<input type="text"/>	
Password *	<input type="text"/>	<input type="text"/>	
Authentication	PAP or CHAP ▼	PAP or CHAP ▼	
IP Mode	IPv4 ▼	IPv4 ▼	
IP Address *	<input type="text"/>	<input type="text"/>	
Dial Number *	<input type="text"/>	<input type="text"/>	
Operator *	<input type="text"/>	<input type="text"/>	
Network Type	automatic selection ▼	automatic selection ▼	
PIN *	<input type="text"/>	<input type="text"/>	
MRU	1500	1500	bytes
MTU	1500	1500	bytes
DNS Settings	get from operator ▼	get from operator ▼	
DNS IP Address	<input type="text"/>	<input type="text"/>	
DNS IPv6 Address	<input type="text"/>	<input type="text"/>	
<i>(The feature of check connection to mobile network is necessary for uninterrupted operation)</i>			
Check Connection	enabled + bind ▼	disabled ▼	
Ping IP Address	8.8.8.8	<input type="text"/>	
Ping IPv6 Address	<input type="text"/>	<input type="text"/>	
Ping Interval	<input type="text"/>	<input type="text"/>	sec
Ping Timeout	10	10	sec

Figure 130: Backup access to the internet – mobile WAN configuration

Backup Routes Configuration	
<input checked="" type="checkbox"/> Enable backup routes switching	
Mode	Single WAN ▼
<input checked="" type="checkbox"/> Enable backup routes switching for Mobile WAN	
Priority	2nd ▼
Weight	<input type="text"/>
<input type="checkbox"/> Enable backup routes switching for PPPoE	
Priority	1st ▼
Ping IP Address	<input type="text"/>
Ping IPv6 Address	<input type="text"/>
Ping Interval	<input type="text"/> sec
Ping Timeout	10 sec
Weight	<input type="text"/>
<input checked="" type="checkbox"/> Enable backup routes switching for WiFi STA	
Priority	1st ▼
Ping IP Address	<input type="text"/>
Ping IPv6 Address	<input type="text"/>
Ping Interval	<input type="text"/> sec
Ping Timeout	10 sec
Weight	<input type="text"/>

Figure 131: Backup access to the internet – backup routes configuration

### 6.3 Secure Network Interconnection with VPN

A Virtual Private Network (VPN) creates a secure, encrypted tunnel over an untrusted public network (like the Internet), allowing two or more separate LANs to communicate as if they were a single, private network. This ensures both the confidentiality and integrity of the data exchanged between the networks.

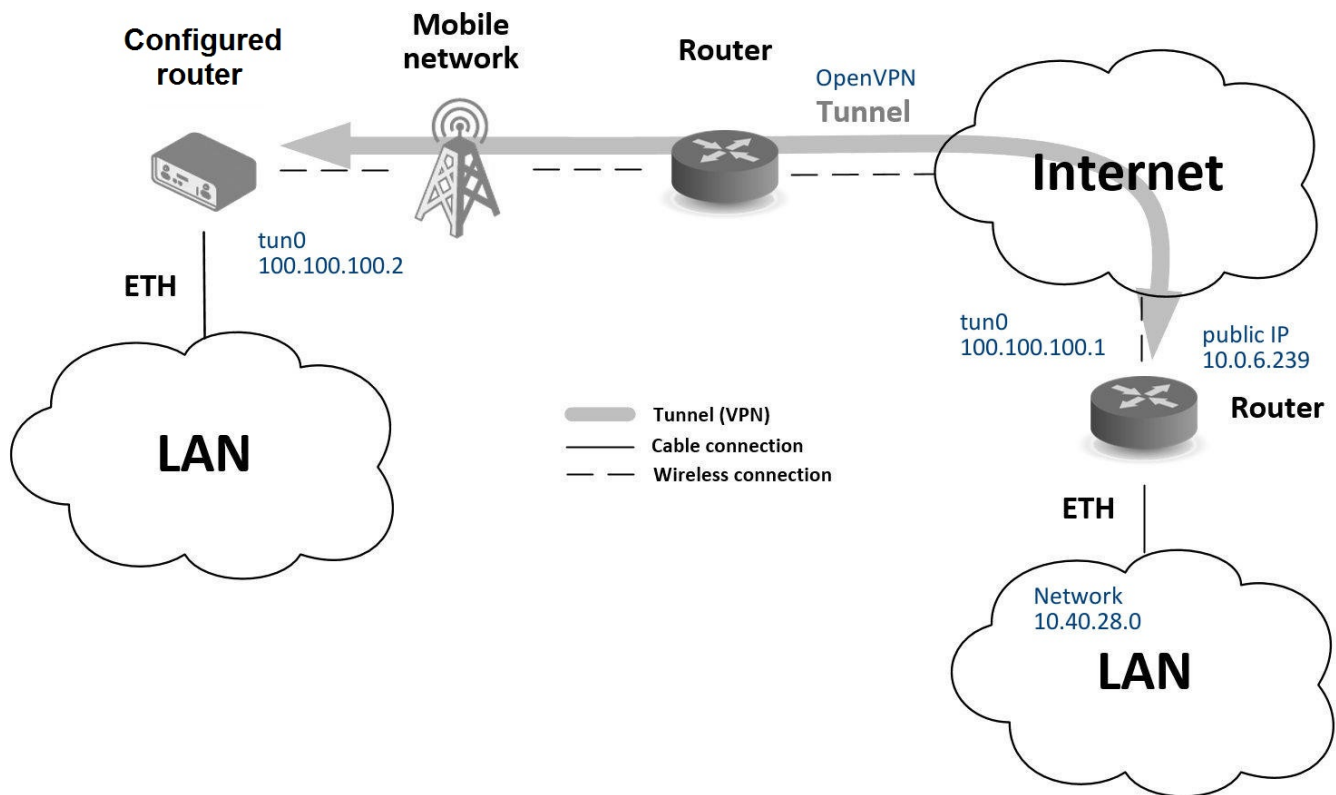

Figure 132: Secure networks interconnection: a topology example

Advantech routers support several VPN protocols, including:

- **OpenVPN:** A highly flexible and secure SSL/TLS-based VPN. See Chapter [3.11 OpenVPN](#) or [OpenVPN Tunnel \[6\]](#) Application Note for details.
- **IPsec:** A standards-based framework for securing IP communications. See Chapter [3.12 IPsec](#) or [IPsec Tunnel \[7\]](#) Application Note for details.

The router also supports non-encrypted tunneling protocols like *GRE*, *PPTP*, and *L2TP*, which can be combined with IPsec to create secure VPNs.

This example demonstrates how to establish an OpenVPN tunnel between two routers using a pre-shared secret key for authentication.

#### Configuration

The setup involves configuring the primary Internet connection and then configuring the OpenVPN tunnel itself.

## Mobile WAN Configuration

A stable Internet connection is required before establishing a VPN tunnel. As in previous examples, the cellular connection can be used as the primary WAN link. Ensure that a SIM card is inserted and an antenna is attached. The router will typically establish a connection automatically. Verify that the mobile connection is active under *Configuration* → *Mobile WAN*, as detailed in Chapter [3.4 Mobile WAN](#).

## OpenVPN Configuration

1. Navigate to *Configuration* → *OpenVPN*.
2. Enable one of the available tunnels by checking *Create 1st OpenVPN tunnel*.
3. Set the *Protocol* and *Port* to match the settings of the remote router (the OpenVPN server).
4. In the *Remote Host and Port* field, enter the public IP address of the remote router.
5. In the *Authentication Mode* dropdown, select *Static key (pre-shared)*.
6. Paste the pre-shared secret key into the *Static key* field.
7. Define the virtual IP addresses for the tunnel endpoints in the *Local Interface IP Address* and *Remote Interface IP Address* fields. These must be unique and form a mini-subnet for the tunnel (e.g., 10.8.0.1 and 10.8.0.2).
8. Click *Apply* to save the configuration.

For more detailed guidance, refer to Chapter [3.11 OpenVPN](#) or [OpenVPN Tunnel \[6\]](#) Application Note.

## Verifying Connectivity

You can confirm that the VPN tunnel is active by checking the following:

- **Network Status Page:** Go to *Status* → *Network*. A new virtual interface, `tun0`, should be listed with the IP address you configured.
- **System Log:** Navigate to *Status* → *System Log*. Look for a log entry stating `Initialization Sequence Completed`, which confirms that the OpenVPN tunnel has been successfully established.

Once the tunnel is active, the two networks are securely interconnected. You can verify this by pinging the remote tunnel endpoint's IP address from the router's command-line interface (accessible via SSH).

1st OpenVPN Tunnel Configuration	
<input checked="" type="checkbox"/> Create 1st OpenVPN tunnel	
Description *	myTunnel
Interface Type	TUN
Protocol	UDP
UDP Port	3000
Remote IP Address *	10.0.6.239
Remote Subnet *	10.40.28.0
Remote Subnet Mask *	255.255.252.0
Redirect Gateway	no
Local Interface IP Address	100.100.100.2
Remote Interface IP Address	100.100.100.1
Remote IPv6 Subnet *	
Remote IPv6 Subnet Prefix Length *	
Local Interface IPv6 Address *	
Remote Interface IPv6 Address *	
Ping Interval *	10 sec
Ping Timeout *	30 sec
Renegotiate Interval *	sec
Max Fragment Size *	bytes
Compression	LZO
NAT Rules	not applied
Authenticate Mode	pre-shared secret
Security Mode	tls-auth
Pre-shared Secret	# # 2048 OpenVPN static key

Figure 133: Secure network interconnection: OpenVPN configuration

### 6.4 Serial Gateway

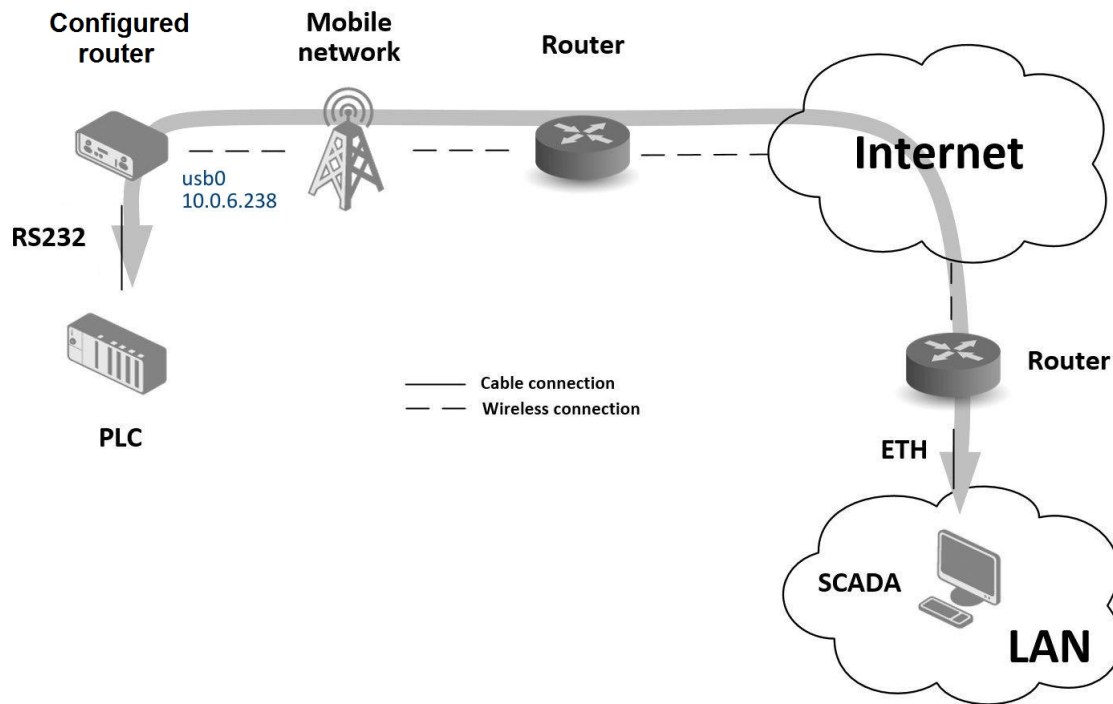

Figure 134: Serial gateway – sample topology

The router’s serial gateway function lets you establish serial connectivity across the Internet or with another network. Serial devices (meters, PLC, etc.) can then upload and download data. (See Fig. 134.) To use this function the router model must have a serial interface.

Configuration is done in the *Configuration* section, *Mobile WAN* and *Expansion Port* item. In this example, the router is equipped with an RS232 interface.

#### Mobile WAN configuration

Mobile WAN configuration is the same as in the previous examples. Just insert the SIM card into the *SIM1* slot at the back of the router and attach the antenna to the *ANT* connector at the front. No extra configuration is needed (depending on the SIM card used). For more details see Chapter 3.4.

#### Expansion Port Configuration

The RS232 interface can be configured in the *Configuration* section, via the *Expansion Port* item. (See fig. 135.) You will need to enable the RS232 port by checking *Enable expansion port 1 access over TCP/UDP*. You may edit the serial communication parameters (not needed in this example). The important items are *Protocol*, *Mode* and *Port*. These set the parameters of communication out to the network and the Internet. In this example the TCP protocol is chosen, and the router will work as a server listening on the 2345 TCP port. Confirm the configuration clicking the *Apply* button.

Expansion Port Configuration	
<input checked="" type="checkbox"/> Enable expansion port access over TCP/UDP	
Port Type	RS-232
Baudrate	9600 ▼
Data Bits	8 ▼
Parity	none ▼
Stop Bits	1 ▼
Flow Control	none ▼
Split Timeout	20 msec
Protocol	TCP ▼
Mode	server ▼
Server Address	
TCP Port	2345
Inactivity Timeout *	sec
<input type="checkbox"/> Reject new connections	
<input type="checkbox"/> Check TCP connection	
Keepalive Time	3600 sec
Keepalive Interval	10 sec
Keepalive Probes	5
<input type="checkbox"/> Use CD as indicator of TCP connection	
<input type="checkbox"/> Use DTR as control of TCP connection	
* can be blank	
<input type="button" value="Apply"/>	

Figure 135: Serial gateway – expansion port configuration

To communicate with the serial device (PLC), connect from the PC (Labeled as SCADA in Fig. 134) as a TCP client to the IP address 10.0.6.238, port 2345 (the public IP address of the SIM card used in the router, corresponding to the usb0 network interface). The devices can now communicate. To check the connection, go to *System Log (Status section)* and look for the *TCP connection established* message.

# Appendix A: Open Source Software License

The software in this device includes various open-source components governed by the following licenses:

- GPL versions 2 and 3
- LGPL version 2
- BSD-style licenses
- MIT-style licenses

A complete list of components and their respective license texts can be found directly on the device. To access them, click the *Licenses* link at the bottom of the router's main web page (*General Status*) or navigate to the following URL in your browser (replace `DEVICE_IP` with the actual router's IP address):

[https://DEVICE\\_IP/licenses.cgi](https://DEVICE_IP/licenses.cgi)

This serves as a written offer, valid for three years from the date of purchase, to provide any third party with a complete machine-readable copy of the corresponding source code on a flash drive medium for a fee no greater than the cost of physically performing the source distribution. If you wish to obtain the source code, please contact us at:

[iiotcustomerservice@advantech.eu](mailto:iiotcustomerservice@advantech.eu)

## **Modifications and debugging of LGPL-linked executables:**

The device manufacturer grants customers the right to use debugging techniques (e.g., decompilation) and modify any executable linked with an LGPL library for their own use. These rights are strictly limited to personal usage—redistribution of modified executables or sharing information obtained through these actions is not permitted.

## **Source code under the GPL license is available at:**

[icr.advantech.com/source-code](http://icr.advantech.com/source-code)

# Appendix B: Glossary and Acronyms

B | D | G | H | I | L | N | O | P | R | S | T | U | V | W | X

## B

**Backup Routes** Allows user to back up the primary connection with alternative connections to the Internet/mobile network. Each backup connection can have assigned a priority. Switching between connections is done based upon set priorities and the state of the connections.

## D

**DHCP** The Dynamic Host Configuration Protocol (DHCP) is a network protocol used to configure devices that are connected to a network so they can communicate on that network using the Internet Protocol (IP). The protocol is implemented in a client-server model, in which DHCP clients request configuration data, such as an IP address, a default route, and one or more DNS server addresses from a DHCP server.

**DHCP client** Requests network configuration from DHCP server.

**DHCP server** Answers configuration request by DHCP clients and sends network configuration details.

**DNS** The Domain Name System (DNS) is a hierarchical distributed naming system for computers, services, or any resource connected to the Internet or a private network. It associates various information with domain names assigned to each of the participating entities. Most prominently, it translates easily memorized domain names to the numerical IP addresses needed for the purpose of locating computer services and devices worldwide. By providing a worldwide, distributed keyword-based redirection service, the Domain Name System is an essential component of the functionality of the Internet.

**DynDNS client** DynDNS service lets you access the router remotely using an easy to remember custom hostname. This client monitors the router's IP address and updates it whenever it changes.

## G

**GRE** Generic Routing Encapsulation (GRE) is a tunneling protocol that can encapsulate a wide variety of network layer protocols inside virtual point-to-point links over an Internet Protocol network. It is possible to create four different tunnels.

## H

**HTTP** The Hypertext Transfer Protocol (HTTP) is an application protocol for distributed, collaborative, hypermedia information systems. HTTP is the foundation of data communication for the World Wide Web.

Hypertext is structured text that uses logical links (hyperlinks) between nodes containing text. HTTP is the protocol to exchange or transfer hypertext.

**HTTPS** The Hypertext Transfer Protocol Secure (HTTPS) is a communications protocol for secure communication over a computer network, with especially wide deployment on the Internet. Technically, it is not a protocol in and of itself; rather, it is the result of simply layering the Hypertext Transfer Protocol (HTTP) on top of the SSL/TLS protocol, thus adding the security capabilities of SSL/TLS to standard HTTP communications.

## I

**IP address** An Internet Protocol address (IP address) is a numerical label assigned to each device (e.g., computer, printer) participating in a computer network that uses the Internet Protocol for communication. An IP address serves two principal functions: host or network interface identification and location addressing. Its role has been characterized as follows: *A name indicates what we seek. An address indicates where it is. A route indicates how to get there*. The designers of the Internet Protocol defined an IP address as a 32-bit number and this system, known as Internet Protocol Version 4 (IPv4), is still in use today. However, due to the enormous growth of the Internet and the predicted depletion of available addresses, a new version of IP (IPv6), using 128 bits for the address, was developed in 1995.

**IP masquerade** Kind of NAT.

**IP masquerading** see NAT.

**IPsec** Internet Protocol Security (IPsec) is a protocol suite for securing Internet Protocol (IP) communications by authenticating and encrypting each IP packet of a communication session. The router allows user to select encapsulation mode (tunnel or transport), IKE mode (main or aggressive), IKE Algorithm, IKE Encryption, ESP Algorithm, ESP Encryption and much more. It is possible to create four different tunnels.

**IPv4** The Internet Protocol version 4 (IPv4) is the fourth version in the development of the Internet Protocol (IP) and the first version of the protocol to be widely deployed. It is one of the core protocols of standards-based internetworking methods of the Internet, and routes most traffic in the Internet. However, a successor protocol, IPv6, has been defined and is in various stages of production deployment. IPv4 is described in IETF publication RFC 791 (September 1981), replacing an earlier definition (RFC 760, January 1980).

**IPv6** The Internet Protocol version 6 (IPv6) is the most recent version of the Internet Protocol (IP), the communications protocol that provides an identification and location system for computers on networks and routes traffic across the Internet. IPv6 was developed by the Internet Engineering Task Force (IETF) to deal with the long-anticipated problem of IPv4 address exhaustion.

While IPv4 still handles a significant portion of internet traffic, IPv6 adoption has grown substantially. As of late 2025, measurements from major content providers show that global user traffic over IPv6 is steadily approaching 50%. IPv6 addresses are represented as eight groups of four hexadecimal digits separated by colons (e.g., 2001:0db8:85a3:0042:1000:8a2e:0370:7334), though various abbreviation methods are also used.

## L

**L2TP** Layer 2 Tunnelling Protocol (L2TP) is a tunnelling protocol used to support virtual private networks (VPNs) or as part of the delivery of services by ISPs. It does not provide any encryption or confidentiality by itself. Rather, it relies on an encryption protocol that it passes within the tunnel to provide privacy.

**LAN** A local area network (LAN) is a computer network that interconnects computers in a limited

area such as a home, school, computer laboratory, or office building using network media. The defining characteristics of LANs, in contrast to wide area networks (WANs), include their usually higher data-transfer rates, smaller geographic area, and lack of a need for leased telecommunication lines.

## N

**NAT** In computer networking, Network Address Translation (NAT) is the process of modifying IP address information in IPv4 headers while in transit across a traffic routing device.

The simplest type of NAT provides a one-to-one translation of IP addresses. RFC 2663 refers to this type of NAT as basic NAT, which is often also called a one-to-one NAT. In this type of NAT only the IP addresses, IP header checksum and any higher level checksums that include the IP address are changed. The rest of the packet is left untouched (at least for basic TCP/UDP functionality; some higher level protocols may need further translation). Basic NATs can be used to interconnect two IP networks that have incompatible addressing.

**NAT-T** NAT traversal (NAT-T) is a computer networking methodology with the goal to establish and maintain Internet protocol connections across gateways that implement network address translation (NAT).

**NTP** Network Time Protocol (NTP) is a networking protocol for clock synchronization between computer systems over packet-switched, variable-latency data networks.

## O

**OpenVPN** OpenVPN implements virtual private network (VPN) techniques for creating secure point-to-point or site-to-site connections. It is possible to create four different tunnels.

## P

**PAT** Port and Address Translation (PAT) or Network Address Port Translation (NAPT) see NAT.

**Port** In computer networking, a Port is an application-specific or process-specific software construct serving as a communications endpoint in a computer's host operating system. A port is associated with an IP address of the host, as well

as the type of protocol used for communication. The purpose of ports is to uniquely identify different applications or processes running on a single computer and thereby enable them to share a single physical connection to a packet-switched network like the Internet.

**PPTP** The Point-to-Point Tunneling Protocol (PPTP) is a tunneling protocol that operates at the Data Link Layer (Layer 2) of the OSI Reference Model. PPTP is a proprietary technique that encapsulates Point-to-Point Protocol (PPP) frames in Internet Protocol (IP) packets using the Generic Routing Encapsulation (GRE) protocol. Packet filters provide access control, end-to-end and server-to-server.

## R

**RADIUS** Remote Authentication Dial-In User Service (RADIUS) is a networking protocol that provides centralized Authentication, Authorization, and Accounting (AAA or Triple A) management for users who connect and use a network service. Because of the broad support and the ubiquitous nature of the RADIUS protocol, it is often used by ISPs and enterprises to manage access to the Internet or internal networks, wireless networks, and integrated e-mail services.

**Root certificate** In cryptography and computer security, a root certificate is either an unsigned public key certificate or a self-signed certificate that identifies the Root Certificate Authority (CA). A root certificate is part of a public key infrastructure scheme. The most common commercial variety is based on the ITU-T X.509 standard, which normally includes a digital signature from a certificate authority (CA). Digital certificates are verified using a chain of trust. The trust anchor for the digital certificate is the Root Certificate Authority (CA). See X.509.

**Router** A router is a device that forwards data packets between computer networks, creating an overlay internetwork. A router is connected to two or more data lines from different networks. When a data packet comes in one of the lines, the router reads the address information in the packet to determine its ultimate destination. Then, using information in its routing table or routing policy, it directs the packet to the next network on its journey. Routers perform the *traffic directing* functions on the Internet. A data packet is typically forwarded from one router to another through the networks that constitute the internetwork until it reaches its destination node.

## S

**SFTP** Secure File Transfer Protocol (SFTP) is a secure version of File Transfer Protocol (FTP), which facilitates data access and data transfer over a Secure Shell (SSH) data stream. It is part of the SSH Protocol. This term is also known as SSH File Transfer Protocol.

**SMTP** The SMTP (Simple Mail Transfer Protocol) is a standard e-mail protocol on the Internet and part of the TCP/IP protocol suite, as defined by IETF RFC 2821. SMTP defines the message format and the message transfer agent (MTA), which stores and forwards the mail. SMTP by default uses TCP port 25. The protocol for mail submission is the same, but uses port 587. SMTP connections secured by SSL, known as SMTPS, default to port 465.

**SMTPS** SMTPS (Simple Mail Transfer Protocol Secure) refers to a method for securing SMTP with transport layer security. For more information about SMTP, see description of the SMTP.

**SNMP** The Simple Network Management Protocol (SNMP) is an *Internet-standard protocol for managing devices on IP networks*. Devices that typically support SNMP include routers, switches, servers, workstations, printers, modem racks, and more. It is used mostly in network management systems to monitor network-attached devices for conditions that warrant administrative attention. SNMP is a component of the Internet Protocol Suite as defined by the Internet Engineering Task Force (IETF). It consists of a set of standards for network management, including an application layer protocol, a database schema, and a set of data objects.

**SSH** Secure Shell (SSH), sometimes known as Secure Socket Shell, is a UNIX-based command interface and protocol for securely getting access to a remote computer. It is widely used by network administrators to control Web and other kinds of servers remotely. SSH is actually a suite of three utilities – `slogin`, `ssh`, and `scp` – that are secure versions of the earlier UNIX utilities, `rlogin`, `rsh`, and `rcp`. SSH commands are encrypted and secure in several ways. Both ends of the client/server connection are authenticated using a digital certificate, and passwords are protected by being encrypted.

## T

**TCP** The Transmission Control Protocol (TCP) is one of the core protocols of the Internet proto-

col suite (IP), and is so common that the entire suite is often called TCP/IP. TCP provides reliable, ordered, error-checked delivery of a stream of octets between programs running on computers connected to a local area network, intranet or the public Internet. It resides at the transport layer.

Web browsers use TCP when they connect to servers on the World Wide Web, and it is used to deliver email and transfer files from one location to another.

## U

**UDP** The User Datagram Protocol (UDP) is one of the core members of the Internet protocol suite (the set of network protocols used for the Internet). With UDP, computer applications can send messages, in this case referred to as datagrams, to other hosts on an Internet Protocol (IP) network without prior communications to set up special transmission channels or data paths. The protocol was designed by David P. Reed in 1980 and formally defined in RFC 768.

**URL** A uniform resource locator, abbreviated URL, also known as web address, is a specific character string that constitutes a reference to a resource. In most web browsers, the URL of a web page is displayed on top inside an address bar. An example of a typical URL would be <http://www.example.com/index.html>, which indicates a protocol (http), a host-name (www.example.com), and a file name (index.html). A URL is technically a type of uniform resource identifier (URI), but in many technical documents and verbal discussions, URL is often used as a synonym for URI, and this is not considered a problem.

## V

**VPN** A virtual private network (VPN) extends a private network across a public network, such as the Internet. It enables a computer to send and receive data across shared or public networks as if it were directly connected to the private network, while benefiting from the functionality, security and management policies of the private network. This is done by establishing a virtual point-to-point connection through the use of dedicated connections, encryption, or a combination of the two.

A VPN connection across the Internet is similar to a wide area network (WAN) link between

the sites. From a user perspective, the extended network resources are accessed in the same way as resources available from the private network.

**VPN server** see VPN.

**VPN tunnel** see VPN.

**RRRP** VRRP protocol (Virtual Router Redundancy Protocol) allows you to transfer packet routing from the main router to a backup router in case the main router fails. (This can be used to provide a wireless cellular backup to a primary wired router in critical applications).

## W

**WAN** A wide area network (WAN) is a network that covers a broad area (i.e., any telecommunications network that links across metropolitan, regional, or national boundaries) using private or public network transports. Business and government entities utilize WANs to relay data among employees, clients, buyers, and suppliers from various geographical locations. In essence, this mode of telecommunication allows a business to effectively carry out its daily function regardless of location. The Internet can be considered a WAN as well, and is used by businesses, governments, organizations, and individuals for almost any purpose imaginable.

**WebAccess/DMP** WebAccess/DMP is an advanced Enterprise-Grade platform solution for provisioning, monitoring, managing and configuring Advantech's routers and IoT gateways. It provides a zero-touch enablement platform for each remote device.

**WebAccess/VPN** WebAccess/VPN is an advanced VPN management solution for safe interconnection of Advantech routers and LAN networks in public Internet. Connection among devices and networks can be regional or global and can combine different technology platforms and various wireless, LTE, fixed and satellite connectivities.

## X

**X.509** In cryptography, X.509 is an ITU-T standard for a public key infrastructure (PKI) and Privilege Management Infrastructure (PMI). X.509 specifies, amongst other things, standard formats for public key certificates, certificate revocation lists, attribute certificates, and a certification path validation algorithm.

## Appendix C: Index

### A

Access Point	
Configuration .....	60
Accessing the router .....	2
Allowed Characters .....	4
APN .....	50
AT commands .....	125
Authentication .....	146

### B

Backup Configuration .....	182
Backup Routes .....	69
Bridge .....	32

### C

Certificate Formats .....	5
Change Profile .....	175
Configuration update .....	151
Connections	
Status .....	27
Control SMS messages .....	124

### D

Data limit .....	53
Default Gateway .....	31, 65
Default IP address .....	2
Default password .....	3
Default SIM card .....	55
Default username .....	3
DHCP .....	23, 31, 65, 201
DHCPv6 .....	33
Dynamic .....	33
Static .....	33
DHCPv6 .....	23, 31, 65
Diagnostic Data	
Save .....	29
DNS .....	201
DNS server .....	31, 52, 65
DNS64 .....	21
Domain Name System .....	see DNS
DoS attacks .....	81
Dynamic DNS	
Configuration .....	114
Status .....	26
Dynamic Host Configuration Protocol .....	see DHCP
DynDNSv6 .....	114

### E

Email	
Sending .....	122
Events .....	155
Actions .....	156
Matrix .....	156
SNMP .....	157

### F

Factory Reset .....	184
Firewall .....	79
Filtering of Forwarded Packets .....	80
Filtering of Incoming Packets .....	80
Protection against DoS attacks .....	81
Firmware	
Update .....	185
Firmware update .....	151
Firmware version .....	9
First-Time Login to the Admin Web Interface .....	3
FTP .....	116

### G

GRE .....	108, 201
-----------	----------

### H

HTTP .....	117
HTTPS .....	117
HTTPS Certificate .....	4

### I

ICMPv6 .....	52
Identification .....	150
IPsec .....	24, 93, 202
IPv4 .....	202
IPv6 .....	7, 21, 30, 34, 50, 52, 79, 84, 89, 93, 159, 161
Dynamic DNS .....	26

### L

L2TP .....	110, 202
LAN	
ETH0 .....	30
ETH1 .....	30
IPv6 .....	30
Link Layer Discovery Protocol .....	119

LLDP .....	119
Neighbors .....	22
Log	
Save .....	29
Logout .....	189

## M

Manage Users .....	168
Mobile network .....	49
Mobile WAN .....	10
Log .....	12
Network Information .....	11
Statistics .....	12
Modify User .....	174
Multiple WANs .....	69

## N

NAPT .....	84
NAT .....	84, 202
NAT64 .....	21
Network Address Translation .....	see NAT
NTP .....	120, 202

## O

Object Identifier .....	133
OpenVPN .....	89, 202

## P

Password	
Forced Change .....	173
PAT .....	84
Peripheral Port	
RS232 .....	141
Peripheral Ports .....	141
PIN code	
Remove .....	177
PoE PSE .....	32
Port .....	202
PPPoE .....	58
PPPoE Bridge Mode .....	56
PPTP .....	112, 203
Prefix delegation .....	34
PUK code .....	178

## Q

Quick Setup .....	162
-------------------	-----

## R

RADIUS .....	36, 60
Reboot .....	187
Remote access .....	85
Remote Management .....	5
Report	
Save .....	29
Reset .....	6
Restore Configuration .....	183
Factory Reset .....	184
From File .....	183
Router .....	1
Accessing .....	2
Router Apps .....	165
Status .....	28
Routing	
Table .....	21

## S

Scripts .....	158, 160
Serial line	
RS232 .....	141
Serial number .....	9
Set internal clock .....	176
SIM card	
Management .....	177
Switch .....	180
Unblock .....	178
Unlock .....	177
Simple Network Management Protocol .....	see SNMP
SMS .....	123
Send .....	181
Service Center .....	179
SMTP .....	122, 203
SNMP .....	131, 203
SSH .....	135
Host Key .....	136
Passwordless Login .....	172
Startup Script .....	158, 160
Static Routes .....	78
Storage .....	6
Switch between SIM Cards .....	54
Syslog	
Authentication .....	139
Configuration .....	137
Forwarding .....	138
System .....	146
System Log .....	29

## T

TCP .....	203
Telnet .....	140
Transmission Control Protocol .....	see TCP

Two-Factor Authentication .....	171
Login .....	171

## U

UDP .....	204
Uniform resource locator .....	see URL
Up/Down script .....	159, 161
URL .....	204
Usage Profiles .....	175
Use Case	
VPN .....	195
User Datagram Protocol .....	see UDP
Users	
Roles .....	169

## V

Virtual private network .....	see VPN
VLAN .....	43

VPN .....	195, 204
IPsec .....	24
WireGuard .....	25
VRRP .....	45, 204
VXLAN .....	106

## W

Web Server .....	117
WebAccess/DMP .....	5
Wi-Fi .....	13
Authentication .....	66
Country Code .....	68
Module Information .....	14
Scan .....	18
Wi-Fi AP .....	60
Wi-Fi STA .....	65
Wi-Fi Station	
Configuration .....	65
WireGuard .....	25, 102

# Appendix D: Related Documents

- [1] Command Line Interface
- [2] Extending Router Functionality
- [3] Remote Monitoring
- [4] WebAccess/DMP
- [5] R-SeeNet
- [6] OpenVPN Tunnel
- [7] IPsec Tunnel
- [8] GRE Tunnel
- [9] WireGuard Tunnel
- [10] FlexVPN
- [11] VLAN
- [12] SNMP Object Identifiers
- [13] AT Commands (AT-SMS)
- [14] Quality of Service (QoS)
- [15] Security Guidelines

[EP] Product-related documents and applications can be obtained on **Engineering Portal** at <https://icr.advantech.com/support/router-models> address.

[RA] **Router Apps** (formerly *User modules*) and related documents can be obtained on *Engineering Portal* at <https://icr.advantech.com/products/router-apps> address.