

Hardware Manual

Industrial Cellular Router

ICR-3241



© 2024 Advantech Czech s.r.o. No part of this publication may be reproduced or transmitted in any form or by any means, electronic or mechanical, including photography, recording, or any information storage and retrieval system without written consent. Information in this manual is subject to change without notice, and it does not represent a commitment on the part of Advantech.

Advantech Czech s.r.o. shall not be liable for incidental or consequential damages resulting from the furnishing, performance, or use of this manual.

All brand names used in this manual are the registered trademarks of their respective owners. The use of trademarks or other designations in this publication is for reference purposes only and does not constitute an endorsement by the trademark holder.

Used symbols



Danger – Information regarding user safety or potential damage to the router.



Attention – Problems that can arise in specific situations.



Information – Useful tips or information of special interest.



Contents

1. Product Overview	1
1.1 Product Introduction	1
1.2 Usage Examples	2
1.3 Hardware Overview	6
1.4 Product Versions	7
1.5 Order Codes	8
1.6 Product Revisions	8
1.7 Package Contents	9
1.8 Product Dimensions	10
1.9 Mounting Recommendations	11
1.10 Wall Mounting	12
1.11 DIN Rail Mounting	13
1.12 Product Label	14
2. Hardware Functionality	15
2.1 SIM Card Slots	15
2.2 Antennas	16
2.3 Bluetooth	16
2.4 Ethernet Interfaces	17
2.5 Power Supply	18
2.6 Low Power Mode	19
2.7 Serial Interfaces and I/O Port	20
2.8 LED Status Indication	22
2.9 Reset Functions	23
3. First Use	24
3.1 Accessories Connection	24
3.2 Router Configuration	24
4. Technical Parameters	25
4.1 Basic Parameters	25
4.2 Standards and Regulations	26
4.3 Type Tests and Environmental Conditions	27
4.4 Parameters of Cellular Module	28
4.5 Parameters of GNSS	28
4.6 Technical Parameters of WiFi	29
4.7 Parameters of Bluetooth	29
4.8 System Configuration	30
Appendix A: Troubleshooting	31
Appendix B: Customer Support	34
Appendix C: Regulatory & Safety Information	35

List of Figures

1	Cellular Internet Access	2
2	Backup for Internet Access	3
3	VPN Networks Interconnection	4
4	Serial Gateway	5
5	Hardware Overview of the Router	6
6	Version without WiFi and GNSS	7
7	Version with WiFi and GNSS	7
8	Basic dimensions of the router box	10
9	Basic dimensions of the router box	10
10	Rotated Wall Mounting Clips	12
11	Removing from the DIN rail	13
12	Product Label	14
13	SIM Cards Insertion	15
14	Ethernet Connector Pinout	17
15	Power connector	18
16	Connection of power supply	18
17	Serial + I/O connector	20
18	Functional scheme of the binary interface	21
19	Resetting the Router	23

List of Tables

1	Hardware Overview of the Router	6
2	Router versions	7
3	Order Codes Overview	8
4	HW Revisions History	8
5	Contents of package	9
6	Ethernet Connector Pinout Description	17
7	Connection of power connector	18
8	Connection of RS485	20
9	Connection of I/O	20
10	Connection of RS232	20
11	Status indication	22
12	Basic parameters	25
13	Standards and Regulations	26
14	Type tests and environmental conditions	27
15	Technical parameters of cellular module	28
16	Technical parameters of GNSS	28
17	Technical parameters of WiFi	29
18	Technical parameters of Bluetooth	29
19	Other technical parameters	30

1. Product Overview

1.1 Product Introduction

ICR-3241 is an industrial cellular router intended for the North American market (NAM). This router is an ideal device for wireless communication in mobile networks that make use of LTE and WCDMA technology. Due to the high speed of data transfer up to 150 Mbps (download) and up to 50 Mbps (upload) is this router an ideal solution for specialized M2M devices and IoT as well as for wireless connection of traffic and security camera systems, individual computers, LAN networks, automatic teller machines (ATM) and other self-service terminals. Dedicated models are FirstNet certified.

The standard configuration includes two Ethernet 10/100 ports, serial line RS232, RS485, one binary input and one output. The device also has two readers for 3 V and 1.8 V SIM cards, which are located on the left panel of the router. The router can be equipped with a WiFi module, but this must be part of the initial configuration – it cannot be assembled to the router at some point in the future. The router can be provided only in a metal casing.

Configuration of the router may be done via a password-protected Web interface. Web interface provides detailed statistics about the router's activities, signal strength, detailed system log etc. The router supports the creation of VPN tunnels using IPSec, OpenVPN and L2TP to ensure safe communication. DHCP, NAT, NAT-T, DynDNS, NTP, VRRP, control by SMS, backup primary connection and many other functions are supported.

The router provides diagnostic functions which include automatically monitoring the PPP connection, automatic restart in case of connection losses, Low Power Mode, and a hardware watchdog that monitors the router status. The user may insert Linux scripts which are started on various actions. It is possible to create up to four different configurations for the same router. These configurations can be switched whenever necessary via Web interface, SMS or binary input status.

The router supports automatic upgrades of both its configuration and firmware, leveraging updates from a central server. This feature ensures that the router remains up-to-date with the latest enhancements and security protocols.

Excluding the routers certified for FirstNet, this model is compatible with Advantech's remote device management platforms: [WebAccess/DMP](#) and [WebAccess/VPN](#). These platforms facilitate comprehensive management and monitoring of network devices.



Examples of possible applications

- mobile office
- fleet management
- security system
- telematic
- telemetric
- remote monitoring
- vending and dispatcher machines

1.2 Usage Examples

Cellular Internet Access

- This example demonstrates a common scenario where the cellular router facilitates access from a local LAN to the Internet via the cellular network.
- This functionality is not available on LAN routers lacking a cellular interface.

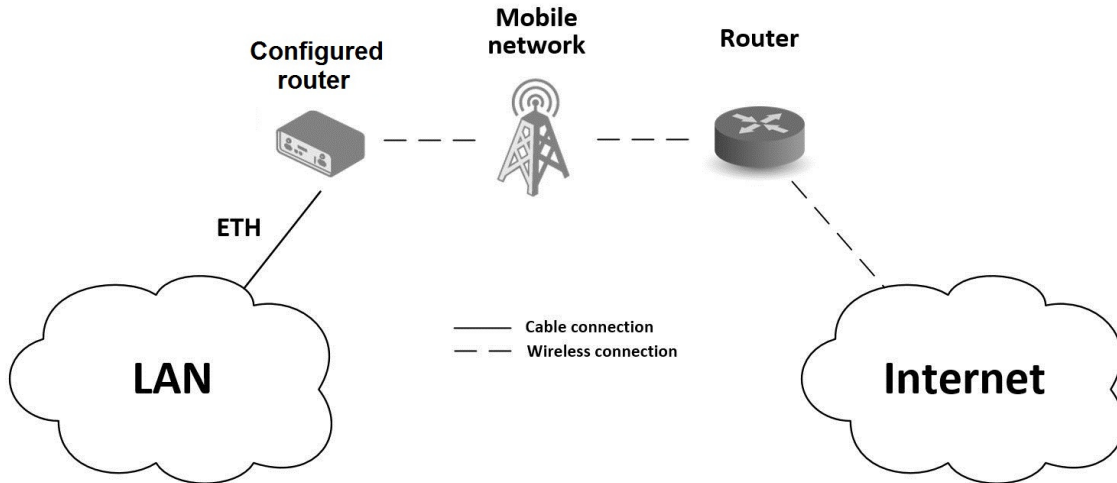

Figure 1: Cellular Internet Access

Backup for Internet Access

- This example showcases how a cellular router's Internet access can be backed up.
- Backup options include PPPoE connections, Ethernet wired connections or WiFi.

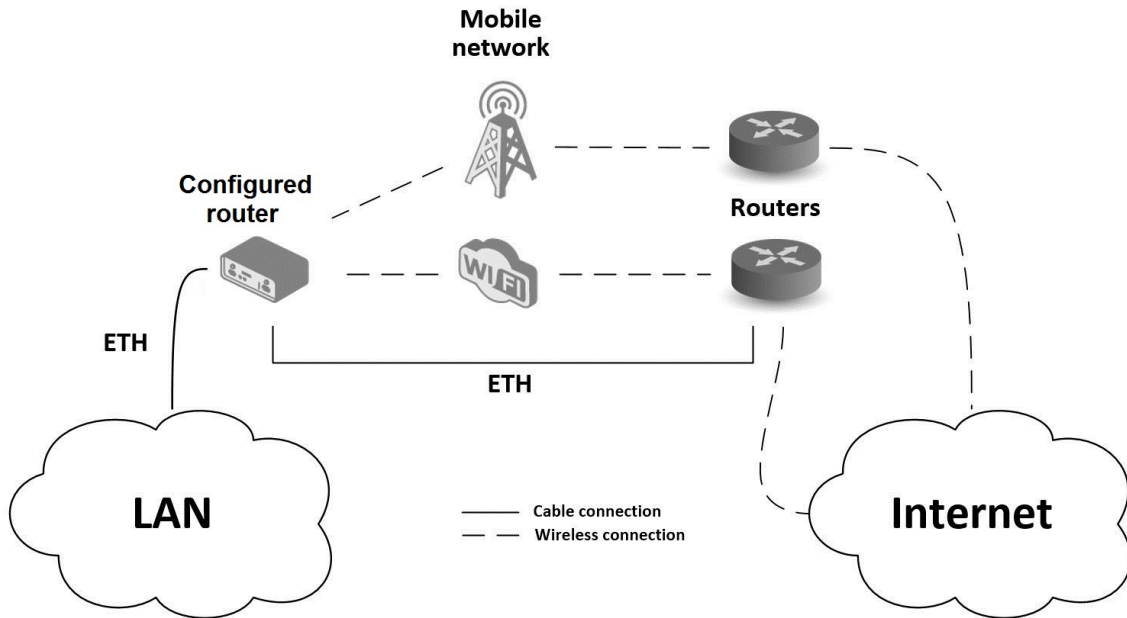

Figure 2: Backup for Internet Access

VPN Networks Interconnection

- This example highlights the establishment of a secure VPN tunnel for interconnecting the configured Advantech router with a router in a remote network, facilitated via the Internet.
- The configured router connects to the Internet using the cellular network.

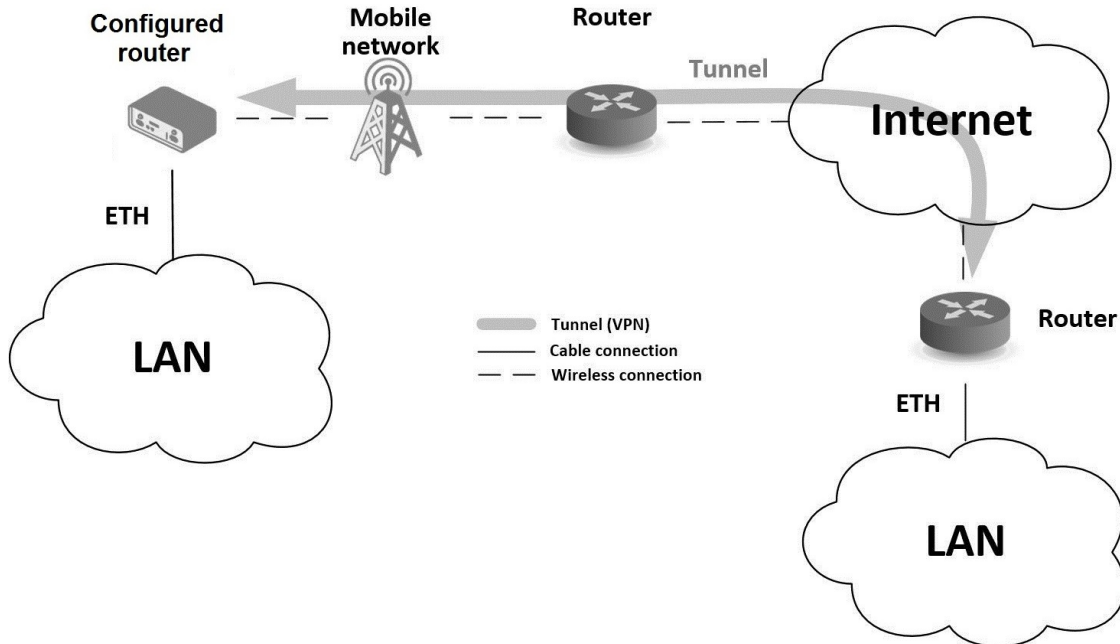

Figure 3: VPN Networks Interconnection

Serial Gateway

- This example depicts a scenario where the configured Advantech router grants access to a PLC device interfaced serially with the router.
- The PLC device, accessible over the entire Internet network, can be controlled from a remote local network, such as one running a SCADA system.
- This functionality is exclusive to routers equipped with a serial interface.

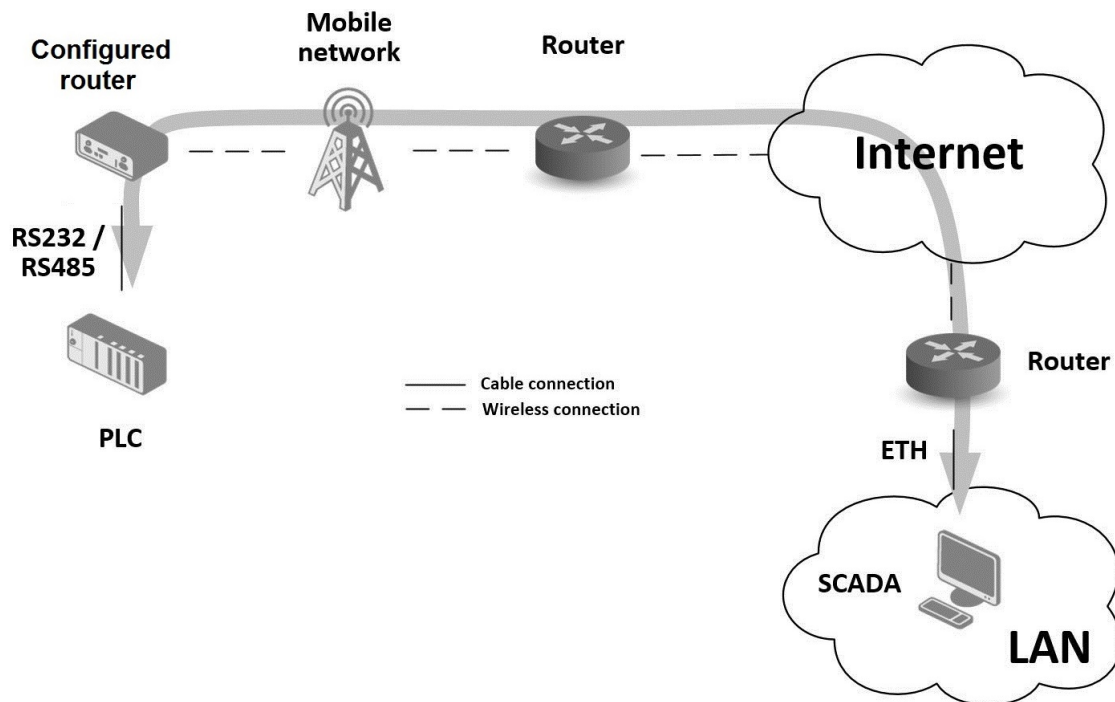

Figure 4: Serial Gateway

1.3 Hardware Overview

The router case preview is shown in Figure 5. A short description of hardware parts of the router is listed in Table 1, including the links to the chapters with a detailed description.

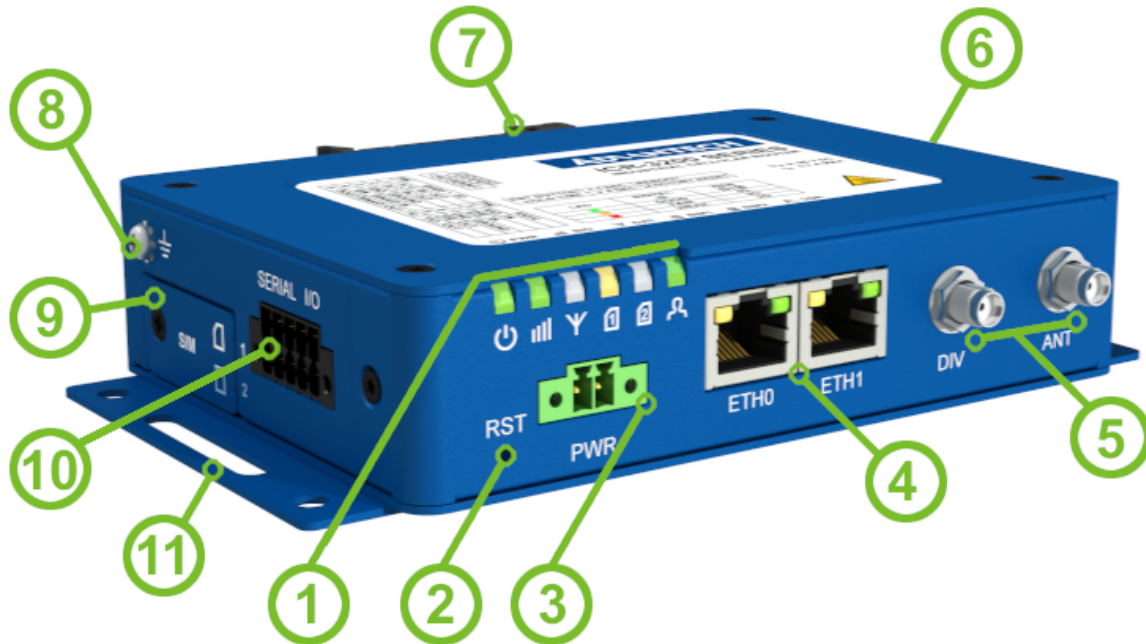

Figure 5: Hardware Overview of the Router

#	Item/Captio	Type	Description
1	LEDs	-	Status LED indication; see Chapter 2.8.
2	RST	-	Button to reboot the router or to restore the default configuration; see Chapter 2.9.
3	PWR	2-pin	Power supply 2-pin terminal socket; see Chapter 2.5.
4	ETH0, ETH1	RJ45	100 MB Ethernet connection for the firts and second LAN; see Chapter 2.4.
5	DIV, ANT	SMA	Connector for the diversity and main antennas of the cellular module; see Chapter 2.2 and Chapter 4.4 for cellular module parameters.
6	WiFi, GNSS	SMA, R-SMA	One SMA connector for the GNSS antenna and two R-SMA connectors for the WiFi antennas. See Chapter 2.2 for more information, Chapter 4.5 for GNSS parameters and Chapter 4.6 for WiFi parameters. The WiFi2 connector can also be used for a Bluetooth antenna. See details in Chapter 2.2 and Chapter 4.7 for bluetooth parameters.
7	DIN clip	-	DIN rail clip, included as standard accessories; see Chapter 1.11.
8	Grounding screw	M3	Pay attention to proper grounding; see Chapter 2.5.
9	SIM slots	Mini SIM	Two SIM card slots; see Chapter 2.1.
10	SERIAL I/O	10-pin terminal	RS232, RS485, binary inputs, and binary outputs interfaces. See Chapter 2.7 for more information.
11	Wall clips	-	Wall mounting clips, included as standard accessories; see Chapter 1.10.

Table 1: Hardware Overview of the Router

1.4 Product Versions

ICR-3241 router is supplied in the following versions (see table below). All versions are available in metal box.

Router versions	SIM	BIN	BOUT	ETH	WiFi	GNSS	RS232	RS485
Version without WiFi and GNSS	2 x	1 x	1 x	2 x			1 x	1 x
Version with WiFi and GNSS	2 x	1 x	1 x	2 x	1 x	1 x	1 x	1 x

Table 2: Router versions



Figure 6: Version without WiFi and GNSS



Figure 7: Version with WiFi and GNSS

1.5 Order Codes

Order codes overview is shown in the table below.

Product type	Product name	Order code	Features – interfaces
ICR-3200	ICR-3241	ICR-3241	LTE module for NAM, 2x ETH, 1x BI, 1x BO, 1x RS232, 1x RS485, 2x SIM reader
ICR-3200	ICR-3241	ICR-3241 W	LTE module for NAM, 2x ETH, 1x BI, 1x BO, 1x RS232, 1x RS485, 2x SIM reader, WiFi , GNSS
ICR-3200	ICR-3241	ICR-3241- 1ND	LTE module for NAM, FirstNet , 2x ETH, 1x BI, 1x BO, 1x RS232, 1x RS485, 2x SIM reader
ICR-3200	ICR-3241	ICR-3241 W-1ND	LTE module for NAM, FirstNet , 2x ETH, 1x BI, 1x BO, 1x RS232, 1x RS485, 2x SIM reader, WiFi , GNSS

Table 3: Order Codes Overview

1.6 Product Revisions

For the product revision history, see the table below. The revision number is printed on the packaging and product labels.

The router GUI can also display the product revision under *Status* → *General* → *System Information* → *Product Revision*. Please note that the default revision (Rev.1.0) is unavailable here.

Rev.#	Description
1.0	Initial version (revision number not printed on the labels).
2.0	PCBU and other changes; see PCN-2022-01 for details.
2.1	PCBU changes; see PCN-2023-06 for details.

Table 4: HW Revisions History

1.7 Package Contents

The standard package of router includes items listed in the following table:





Item#	Description	Figure	Q'ty
1	ICR-3241 or ICR-3241W router		1 pcs
2	DIN holder (screwed on the router)		1 pcs
3	Wall clips for wall mounting (screwed on the router)		2 pcs
4	2-pin terminal block for power supply (deployed on the router)		1 pcs
5	10-pin terminal block for RS232, RS485 and I/O (deployed on the router)		1 pcs
6	<i>Quick Start Guide Leaflet</i>		1 pcs

Table 5: Contents of package

1.8 Product Dimensions

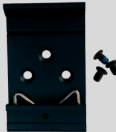
For the dimensions of the product in metal and plastic boxes see the figures below. Note that all sizes are measured in millimeters.

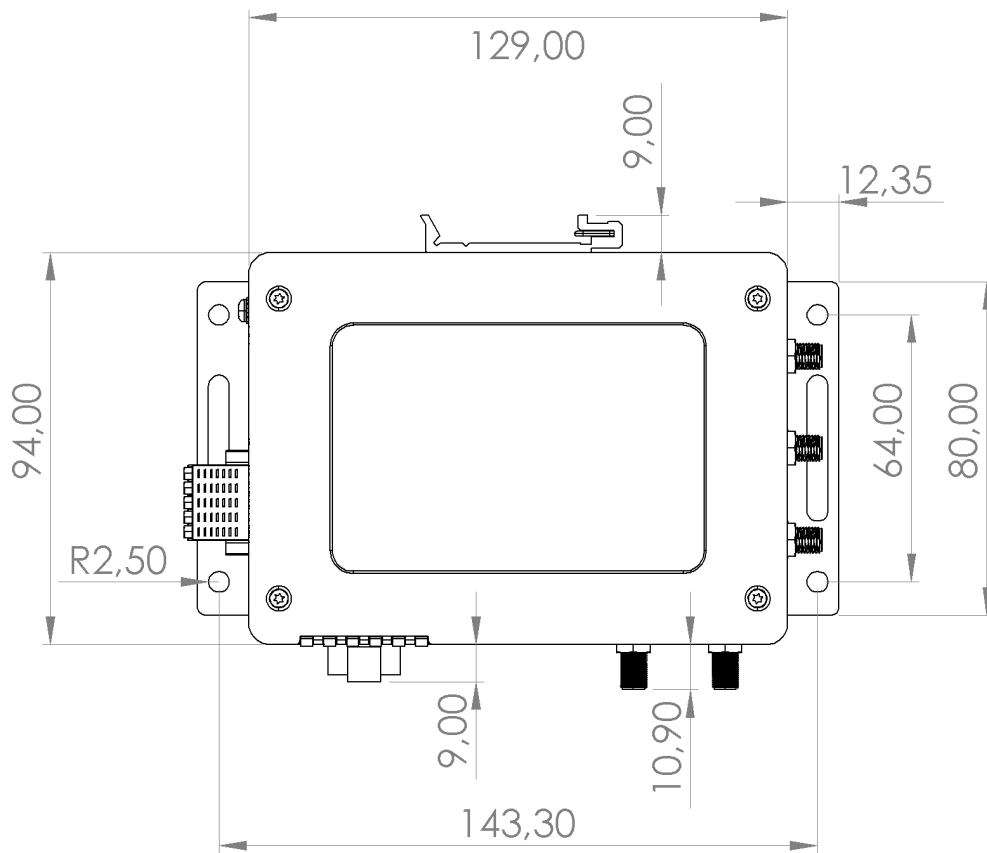

Figure 8: Basic dimensions of the router box

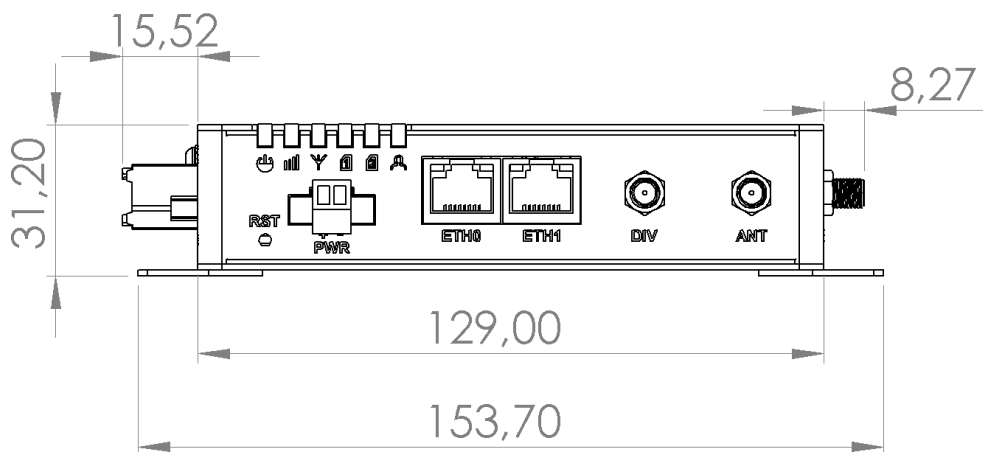

Figure 9: Basic dimensions of the router box

1.9 Mounting Recommendations

The router can be placed:

- on a flat surface,
- on a wall (or another surface) using the side clips,
- on a DIN rail EN 60715 with the included metal DIN rail clip.

For most applications with a built-in router within a switchboard, it is possible to recognize two kinds of environments:

- A non-public, industry environment of low voltage with high interference,
- a public environment of low voltage and without high interference.

For both of these environments, it is possible to mount the router to a switchboard, after which there is no need to have examination immunity or issues in connection with EMC according to EN 61439-1:2011.



In compliance with the EN 61439-1:2011 specification, it is necessary to observe the following assembly instructions for a router attached to a switchboard:

- For whip antennas it is recommended to observe a minimum distance of 6 cm from cables and metal surfaces on every side in order to avoid interference. When using an external antenna separate from the switchboard it is necessary to fit a lightning conductor.
- When mounting a router on sheet-steel we recommend using a cable antenna.
- For all cables, we recommend to bind the bunch, and for this we recommend:
 - The length of the bunch (the combination of power supply and data cables) should be a maximum 1.5 m. If the length of data cables exceeds 1.5 m or if the cable is leading towards the switchboard, we recommend installing surge protectors.
 - Data cables must not have a reticular tension of ~ 230 V/50 Hz or ~ 120 V/60 Hz.
- Sufficient space must be left between each connector for the handling of cables,
- To ensure the correct functioning of the router we recommend the use of an earth-bonding distribution frame for the grounding of the power supply of the router, data cables and antenna within the switchboard.

1.10 Wall Mounting

i The wall mounting clip is supplied with the router as standard accessories.

The router can be screwed to a wall (or another surface) using the wall mounting clips. Two wall mounting clips are assembled to the router during the production and need to be rotated as shown of Figure 10.

There are two wholes on the clip with a diameter of 5 millimeters. For detailed information about the mounting dimensions see Chapter 1.8.

! When mounting the wall mounting clip, tighten the screws with max. torque of 0.4 Nm.

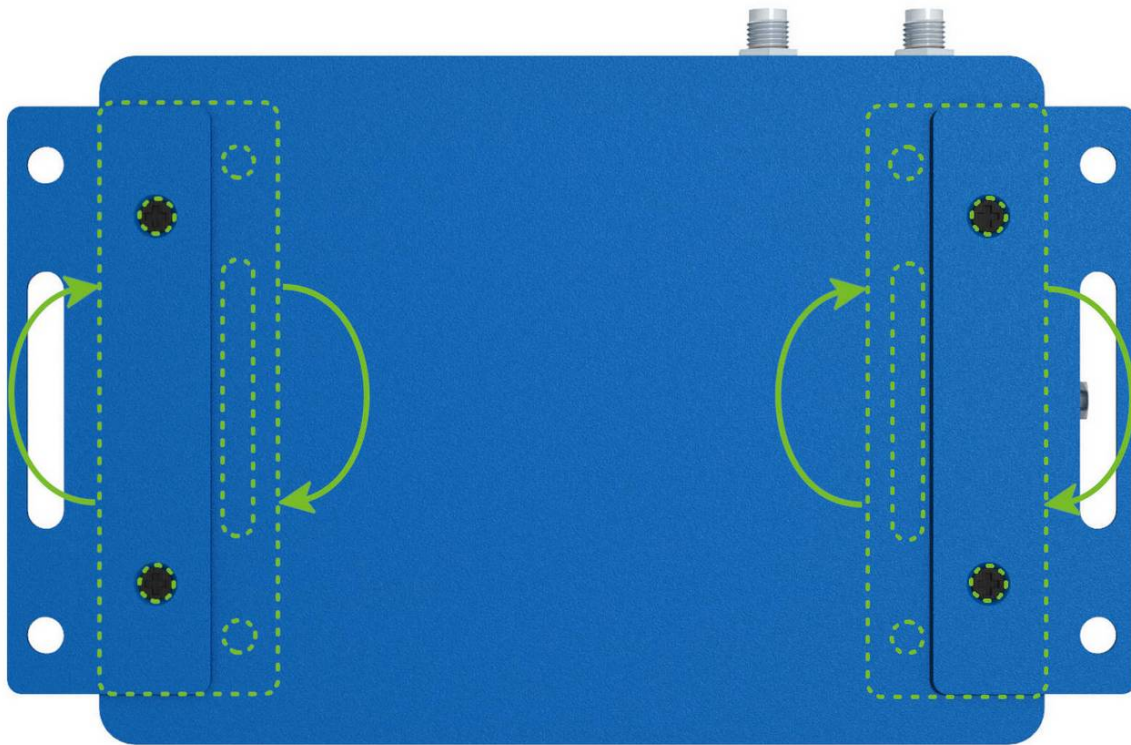

Figure 10: Rotated Wall Mounting Clips

1.11 DIN Rail Mounting

i The DIN rail clip is suitable for a DIN rail according to EN 60715 standards.

! When mounting the DIN rail clip, tighten the screws with max. torque of 0.4 Nm.

To remove the router from the DIN rail it is necessary to lightly push down the router so that the bottom part of the DIN rail clip hitched to the DIN rail get out of this rail and then fold out the bottom part of the router away from the DIN rail.

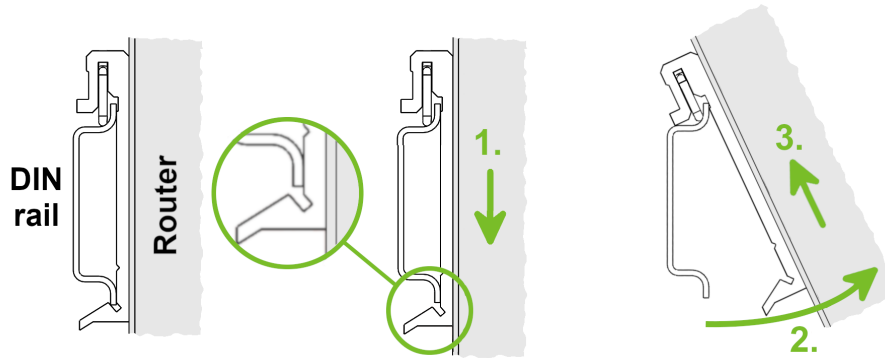

Figure 11: Removing from the DIN rail

1.12 Product Label

The figure below shows an example of the product labels with all the information printed on them.



Figure 12: Product Label

2. Hardware Functionality

See Chapter 1.3 for an overview of the product's hardware, along with links to chapters offering detailed explanations.

2.1 SIM Card Slots

Slots for two SIM cards are located on the router beneath a metal cover. If you plan to use this device for cellular network communication, insert an activated data-provisioned SIM card into the SIM card slot.

You have the option to install two SIM cards simultaneously for utilizing the switching feature. The SIM cards can have different Access Point Names (APNs) configured. The procedure for changing SIM cards is outlined below. If the SIM requires a PIN, input it in the router's web interface (*Administration* → *Unlock SIM Card*).

 Type of SIM card: Mini SIM (2FF) 25.0 × 15.0 × 0.76 mm.

Inserting the SIM card:

- Always disconnect the router from the power supply before handling the SIM card.
- Unscrew the two screws on the SIM card cover and remove the cover.
- To remove an inserted SIM card, use the flat end of a spudger or your fingernail to press the SIM card slightly into its slot until you hear a click. Upon hearing the click, release the card, and it will pop out of its slot.
- To insert a SIM card, push the card into the slot until it clicks into place.
- Put the cover back and secure it with the two screws.

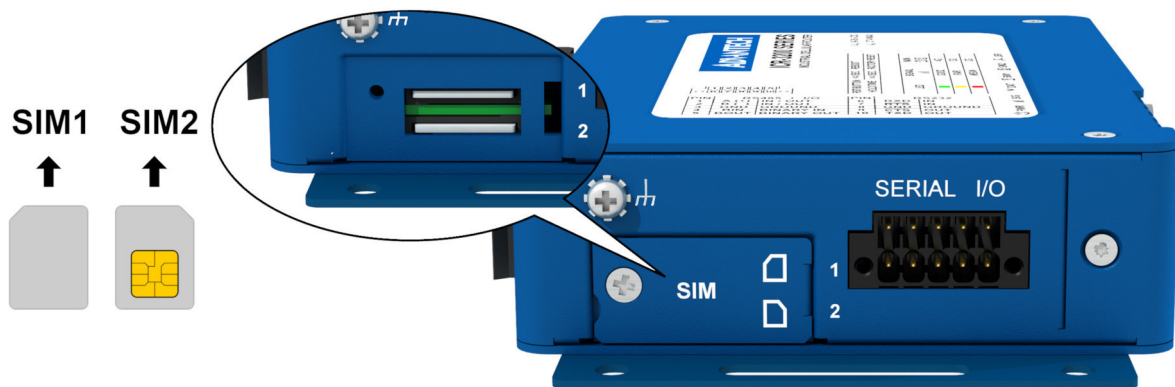

Figure 13: SIM Cards Insertion

2.2 Antennas

Connect cellular antennas to the router to main (ANT) and diversity (DIV) SMA female connectors on the front panel. For WiFi models, connect WiFi antennas to the router to *WiFi1* and *WiFi2* RP-SMA female connectors on the right panel. Connect the GNSS antenna to the router to GNSS SMA female connector on the right panel between the WiFi antennas.



Only run the router with a cellular antenna connected to the main antenna connector, as the energy from the transmission is effectively reflected by the open end and can damage the equipment.



The DIV cellular antenna is required for the MIMO DL functionality.



Recommended tightening moment for screwing the antenna to the SMA female connectors is 0.9 Nm.



To get maximum throughput when operate WiFi at MIMO 2x2, two antennas with at least 25 dB isolation is recommended.

2.3 Bluetooth

The *WiFi2* connector is compatible with Bluetooth antennas. For detailed Bluetooth specifications, refer to Chapter 4.7. Our router's Bluetooth functionality is divided into three main components:

1. **Kernel Support and Drivers:** Integrated from firmware version 6.2.6, this includes kernel-level Bluetooth support and necessary drivers.
2. **Bluetooth Router Application with BlueZ:** This application, featuring the BlueZ Linux Bluetooth stack, enhances the router's Bluetooth capabilities. It is not pre-installed on the router. To use this feature, download the Bluetooth Router App from our website¹ and install it manually.
3. **Node-RED Applications:** For advanced Bluetooth functionality, Node-RED and its Bluetooth node can be utilized. Like the Bluetooth Router App, *Node-RED*² and the *Node-RED Bluetooth Node*³ are not pre-installed and require manual installation on the router.

¹<https://icr.advantech.com/products/software/user-modules#bluetooth>

²<https://icr.advantech.com/products/software/user-modules#node-red>

³<https://icr.advantech.com/products/software/user-modules#node-red-bluetooth-node>

2.4 Ethernet Interfaces

The panel socket of RJ45 is used for Ethernet interface. The pinout of the socket is shown in Figure 14 and described in Table 6.

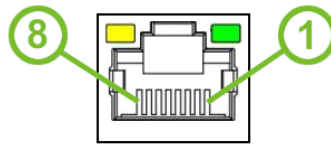

Figure 14: Ethernet Connector Pinout

Pin	Signal mark	Description
1	Tx+	Transmit Data+ (positive pole)
2	Tx-	Transmit Data- (negative pole)
3	Rx+	Receive Data+ (positive pole)
4	—	—
5	—	—
6	Rx-	Receive Data- (negative pole)
7	—	—
8	—	—

Table 6: Ethernet Connector Pinout Description

 The isolation barrier of the Ethernet ports against the ground is 1500 V.

2.5 Power Supply

Terminal block 3.5 mm.

Pin number	Signal mark	Description
1	VCC(+)	Positive pole of DC supply voltage (+9 to +36 V DC)
2	GND(-)	Negative pole of DC supply voltage

Table 7: Connection of power connector

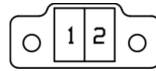

Figure 15: Power connector

Power supply for router is required between +9 V to +36 V DC supply. Protection against reversed polarity without signaling is built into the router.



If the router is grounded, using the grounding screw, there is no protection against the reversed polarity. The negative pole of the DC power supply must be at the same voltage reference as the grounding screw. If not, a voltage difference between these two points might damage the router, and only an authorized service center can fix it.

For correct operation it is necessary that the power source is able to supply a peak current of 1.2 A.



Unit has to be supplied by a power supply specified as a Limited Power Source (LPS) or CEC/NEC Class 2 source of supply.

Circuit example:

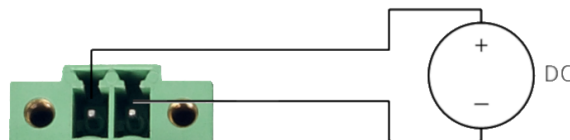

Figure 16: Connection of power supply



All metal parts, including the box, are connected together with the negative pole of power supply (common pole). To ground the router can be used the grounding screw located on the left panel.

2.6 Low Power Mode



In applications requiring low power consumption (such as solar power - not 7/24 mode) is strictly recommended to use LPM mode prior to powering down the entire router.

LPM (Low Power Mode) is a router mode where the router is in sleep mode with minimal power consumption; see Chapter [efchap:BasicParams](#) for the LPM consumption. The router can be woken up from this mode by a signal applied to the BIN0 input or after a predetermined period of time. Putting the router into LPM mode can be done using the `lpm` command, see [Commands and Scripts](#) application note for more details.

2.7 Serial Interfaces and I/O Port

The RS232 and RS485 serial interfaces together with the I/O interface are physically connected to the 10-pin panel socket. All three interfaces are not isolated from the router. The pinout of this connector is described in the tables below.

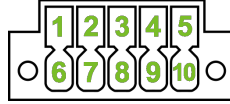

Figure 17: Serial + I/O connector

Pin	Signal mark	Description
1	B (+)	IN/OUT
2	A (-)	IN/OUT
3	GND	GROUND

Table 8: Connection of RS485



We recommend connecting a termination resistor outside the router. Without termination resistors, signal reflections off the unterminated end of the cable can cause data corruption. Termination resistors also reduce electrical noise sensitivity due to the lower impedance.

Pin	Signal mark	Description
4	BIN	BINARY IN
5	BOUT	BINARY OUT

Table 9: Connection of I/O

Pin	Signal mark	Description
6	RXD	IN
7	CTS	IN
8	GND	GROUND
9	RTS	OUT
10	TXD	OUT

Table 10: Connection of RS232

The I/O user interface is designed for binary input processing and binary output control. By default, the binary output is open, so it is not grounded. The maximum binary output load is 36 V at 500 mA. The constant current supplied by the binary input is 3 mA.

The functional scheme of connection for the binary input and binary output is drawn on the picture below.

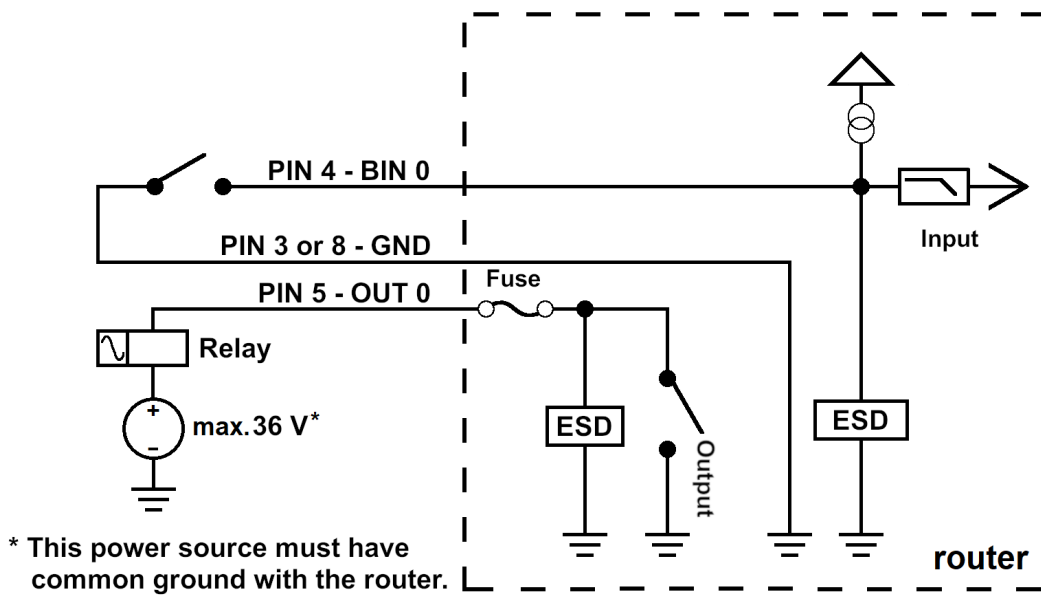

Figure 18: Functional scheme of the binary interface

2.8 LED Status Indication

There are six LED indicators on the front panel to provide router status information. Each ETH port has two additional LEDs that provide information about the port status.







	Caption	Color	State	Description
	PWR	Green Green Green	On Blinking Fast blinking	Starting of the router Router is ready Updating firmware
	SIG	Green Orange Red	On On On	Good signal Fair signal Poor signal
	DAT	Green	Blinking	Communication in progress on radio channel
	SIM1	Green Green Orange Red	Blinking On On Fast blinking	SIM is selected, router waits for data connection 4G technology 3G technology SIM card problem (missing SIM card or PIN code not entered)
	SIM2	Green Green Orange Red	Blinking On On Fast blinking	SIM is selected, router waits for data connection 4G technology 3G technology SIM card problem (missing SIM card or PIN code not entered)
	USR	Green	On / Blinking / Fast blinking	Function of this LED diode can be selected by user
	ETH0 ETH1	Green Green	On Off	Selected 100 Mbps Selected 10 Mbps
	ETH0 ETH1	Yellow Yellow Yellow	On Brief off blinks Off	The network cable is connected Data transmission The network cable is not connected

Table 11: Status indication

2.9 Reset Functions

The RST button has multiple functions depending on the firmware platform. For more information, see the configuration manual [1], chapter *Manual Introduction* → *Device* → *Reset*.

-  Use a narrow screwdriver or any small tool to press the *RST* button.

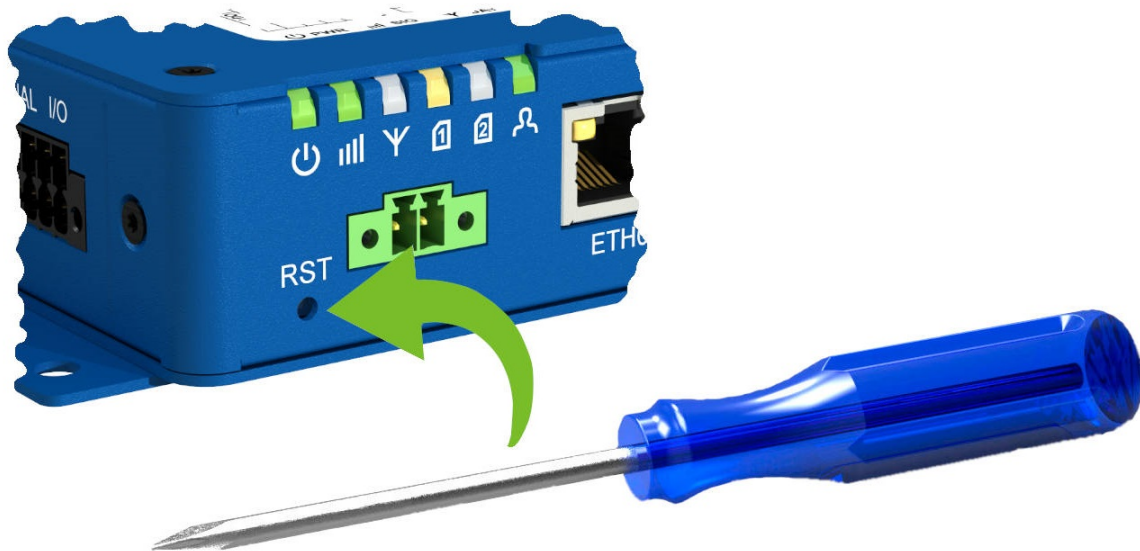

Figure 19: Resetting the Router

3. First Use

3.1 Accessories Connection

Before putting the router into operation, make sure to connect all the components required for running your applications. Refer to Chapter 1.3 for an overview of the hardware. Also, remember to insert a SIM card for the cellular connection as explained in Chapter 2.1.



Ensure you do not operate the router without an antenna connected to the main antenna connector. Transmitting energy is effectively reflected by the open end, which could potentially damage the equipment.

3.2 Router Configuration

You can perform the initial configuration of the router using a web browser on your PC. This interface allows for router monitoring, configuration, and administration.

Begin by connecting the power supply to the router (refer to Chapter 2.5). The router will initiate its boot process. By default, the router will automatically establish a connection to the default Access Point Name (APN) of the inserted SIM card. Ensure your PC is configured to obtain IP settings automatically from the network. Connect your PC's network card to the default LAN interface of the router, Ethernet port ETH0. The DHCP server will assign an IP address to your PC.

To access the router's web interface, enter the following address in your web browser: <https://192.168.1.1>. Please note that using the HTTPS protocol for secure communication over the network is mandatory. The default user is `root`. Check the **product label** on the router for the **default password**¹. The user will be prompted to **change their password** when logging into the new router for the **first time**.



Consult the router **Configuration Manual [1]** for detailed descriptions and examples of router configuration.



For security reasons, we recommend regularly updating the router's firmware to the latest version. Downgrading the firmware to an older version than the production version or uploading firmware intended for a different device may cause the device to malfunction.



All routers have the *WebAccess/DMP* client pre-installed by default. The activated client periodically uploads router identifiers and configuration to the *WebAccess/DMP* server. See the configuration manual [1], chapter *Basic Information* → *WebAccess/DMP Configuration*, for more information.

¹If the router's label does not specify a unique password, use "root" as the default password.

4. Technical Parameters

4.1 Basic Parameters

Parameter		Description
Temperature range	Operating Storage	-40 °C to +75 °C (-40 °F to +167 °F) -40 °C to +85 °C (-40 °F to +185 °F)
Humidity	Operating Storage	0 to 95 % relative humidity non condensing 0 to 95 % relative humidity non condensing
Altitude	Operating	2000 m / 70 kPa
Degree of protection		IP30
Supply voltage		9 to 36 V DC
Battery for RTC		CR1225
Consumption of the router with WiFi module @ 9 V	Idle Average Peak LPM mode	2.6 W 4.3 W 5.8 W 20 mW ¹
Dimensions of device		31,2 × 94 × 129 mm (1.23" × 3.7" × 5.08")
DIN rail clip dimensions		DIN 35 mm, EN 60715
Weight	Metal box	480 g (1.05 lbs) for non-WiFi version 500 g (1.1 lbs) for WiFi version

Table 12: Basic parameters

¹100 mW for product revision lower than 2.0

4.2 Standards and Regulations

The router complies with the following standards and regulations:

Parameter	Description
Radio	PTCRB
EMC	FCC 15.107 Class B, FCC 15.109 Class B, IC
Safety	FCC 47 CFR Part 1, UL/EN/AS/NZS 62368-1
Carrier approvals	AT&T, Verizon, T-Mobile US, FirstNet ¹
Transportation	E-Mark E8 homologation number: 10R – 05 10350, EN 45545-2
Railway	EN 50155 (A1, OT4, ST1, H1, Cat 1 Class B, S1, C1, L4, PD2, K2, PC2)
National	FCC, IC
Environmental	REACH, RoHS3 and WEEE compliant

Table 13: Standards and Regulations

¹Dedicated models only.

4.3 Type Tests and Environmental Conditions

Phenomena	Test	Description	Test levels
ESD	EN 61000-4-2	Enclosure contact Enclosure air	± 6 kV (crit. A) ± 8 kV (crit. A)
RF field AM modulated	EN 61000-4-3	Enclosure	20 V/m (crit. A) (80 – 1000 MHz) 10 V/m (crit. A) (1 – 6 GHz)
Fast transient	EN 61000-4-4	Signal ports Power ports Ethernet ports	± 1 kV (crit. A) ± 2 kV (crit. A) ± 1 kV (crit. A)
Surge	EN 61000-4-5	Ethernet ports Power ports	± 1 kV (crit. A), shielded cab. ± 2 kV (crit. A)
RF conducted	EN 61000-4-6	All ports	10 V/m (crit. A) (0,15 – 80 MHz)
Radiated emission	EN 55032	Enclosure	Class B
Conducted emission	EN 55032	DC power ports Ethernet ports	Class B Class B
Dry heat	EN 60068-2-2 MIL-STD-810G SAE J1455	+75 °C *, 40 % rel. humidity	
Cold	EN 60068-2-1 MIL-STD-810G SAE J1455	-40 °C *	
Damp heat	EN 60068-2-78 MIL-STD-810G SAE J1455	95 % rel. humidity (+40 °C)	
Vibration	EN 60068-2-64 ed.2 MIL-STD-810G SAE J1455	Vibration spectrum A.3 (rolling stock)	Category 1 (3 axis, 8 hours per axis)
Shock	EN 60068-2-27 ed.2 MIL-STD-810G SAE J1455	half-sine, 50 g peak, 11 ms	

Table 14: Type tests and environmental conditions

4.4 Parameters of Cellular Module

Parameter	Description
LTE parameters	LTE: Cat.4, 3GPP E-UTRA Release 11 LTE technology FDD frequencies: B71 (600 MHz), B12, B13, B14 (700 MHz), B5 (850 MHz), B4, B66 (1700 MHz), B2 (1900 MHz) LTE FDD bit rates: 150 Mbps (DL) / 50 Mbps (UL) Supported bandwidths: 1.4 MHz, 3 MHz, 5 MHz, 10 MHz, 15 MHz, 20 MHz
WCDMA parameters	Supported frequencies: B5 (850 MHz), B4 (1700 MHz), B2 (1900 MHz) Bit rates: 4.2 Mbps (DL) / 2.2 Mbps (UL)

Table 15: Technical parameters of cellular module

Antenna Requirements

- VSWR: <2:1 (Antenna input impedance response as function of frequency. This shows the antenna resonances and its bandwidth).
- SMA: 50 Ω
- For good diversity performance, the primary and secondary antennas should have different polarizations.

4.5 Parameters of GNSS

Parameter	Description
Antenna	50 Ω – active
Protocols	NMEA 0183
GNSS Systems	GPS, GLONASS, BeiDou, Galileo, QZSS
Frequency	GPS/Galileo/QZSS: 1575.42 \pm 1.023 MHz GLONASS: 1597.5 – 1605.8 MHz BeiDou: 1561.1 \pm 2.046 MHz
Sensitivity (autonomous)	Tracking: -157 dBm Reacquisition: -157 dBm Cold start: -146 dBm
Acquisition time (autonomous)	Hot start: 2.5 s Warm start: 26 s Cold start: 35 s
Accuracy	< 1.5 m

Table 16: Technical parameters of GNSS

4.6 Technical Parameters of WiFi

Parameter	Description
Antenna connector	2x R-SMA – 50 Ω (MU-MIMO)
Supported WiFi bands	2.412 to 2.462 GHz, 5.180 to 5.825 GHz
Standards	IEEE: 802.11b, 802.11b+g, 802.11b+g+n, 802.11a, 802.11a+n, 802.11ac
2.4 GHz supported channels	1, 2, 3, 4, 5, 6, 7, 8, 9, 10, 11
5 GHz supported channels	36, 40, 44, 48, 149, 153, 157, 161, 165
Type of device	Access point, Station
Security – Standards	WEP, WPA, WPA2, WPA3, 802.1X
Security – Encryption	WEP, TKIP, AES
Security – EAP Types	EAP-FAST, EAP-TLS, EAP-TTLS, PEAP-GTC, PEAP-MSCHAPv2, PEAP-TLS, LEAP
AP maximum users	Unlimited (WiFi module supports multi-role operation in STA and AP).

Table 17: Technical parameters of WiFi

4.7 Parameters of Bluetooth

Parameter	Description
Bluetooth Standards	Bluetooth version 2.1 with Enhanced Data Rate Bluetooth 4.2 (Bluetooth Low Energy or BLE)
Features	Bluetooth 4.2 (BDR/EDR/LE), Bluetooth class 1 Adaptive Frequency Hopping (AFH) using Package Error Rate (PER)
Antenna	Shared with WiFi2 R-SMA connector
Frequency Range	2.4 to 2.4835 GHz
Data Rates Supported	1 Mbps (GFSK), 2 Mbps ($\pi/4$ -DQPSK), 3 Mbps (8-DPSK)
Bluetooth Modulation	GFSK@ 1 Mbps $\pi/4$ -DQPSK@ 2 Mbps 8-DPSK@ 3 Mbps
Encryption support	AES

Table 18: Technical parameters of Bluetooth

4.8 System Configuration

Parameter	Description
CPU	Cortex A8, 1 GHz 2 DMIPS per MHz
Flash memory	Available memory space 1 862 MB <ul style="list-style-type: none">• 2x 256 MB – FW• 512 MB – User data storage• 838 MB – Space for Router Apps
RAM	512 MB

Table 19: Other technical parameters

Appendix A: Troubleshooting

If you cannot connect to the router from your PC, your network card may be configured in such a way that it is not possible to connect to the router. Take one or more of the following steps in order to solve the problem:

- Make sure your PC's network card is configured to obtain the IP address from the DHCP server (by default the DHCP server is running in the router).
- Connect the router to the PC via Switch.
- Connect the router to the PC, start the router first and then start the PC after the router's initialization.

Ethernet connection fails or is not establishing.

- It is possible to turn auto negotiation off and set a rate and duplex manually on the Ethernet interface of the router. Available on "LAN Configuration" page in the router.

Mobile WAN connection fails.

- Check the signal power ("Mobile WAN status" page). If the signal power is weak, you will have to use a better antenna. If the neighbouring cells have a similar signal strength, you will need to use a directional antenna. For proper operation, the signal levels have to be good.
- Try to enable automatic ping from the router, which will check the connection when there are no data running and in the case of a failed ping, restart the connection. This can be done on the "Mobile WAN Configuration" page in the router in the "Check connection" section. "Enable + bind" option is to ensure the ping goes always through Mobile WAN network interface.

Mobile WAN connection cannot be established.

- Check the "Mobile WAN Configuration" – APN, name, password and IP address (all can be blank).
- Try to enter the SIM card PIN – verify that the SIM card has the PIN code entered. Available on "Unlock SIM Card" page in the "Administration" section.
- In a private APN it is not recommended to get the DNS settings from operator (on "Mobile WAN" page)
- Go to "System Log" page in "Status" section and observe where the error occurs.

I cannot connect from the Internet to the device behind the router. I have NAT enabled.

- The device's gateway has to be configured so it points to the router.

I can't access my Web server placed behind the router over NAT.

- The remote HTTP access to the router has to be disabled on "NAT Configuration" page in the router. Also enable "Send all remaining incoming packets to default server" feature and fill in the IP address of your Web server. On the Web server, the default gateway has to be the IP address of the router.

DynDNS doesn't work.

- With private APN this will not work.

- If the same IP address is recorded in your canonic name as a dynamically assigned address, it means that the operator is using NAT or a firewall.
- You can verify NAT using ping to your server with static address and then compare with router's IP address.
- You can verify a Firewall by accessing remotely to the router's Web interface.
- The operator may not provide the address of DNS server and without DNS server's address it is impossible to connect to the dyndns.org server. The following messages will be shown in the System Log:
 - DynDNS daemon started
 - Error resolving hostname: no such file or directory
 - Connect to DynDNS server failed

 **L2TP or IPSec isn't establishing.**

- Check the "System Log" page for error messages.

 **IPSec tunnel establishes but the communication does not run.**

- Probably there are bad routing rules defined in the connected devices, or the default gateway.

 **I switched the router to offline mode by SMS message, but the router is in online mode after reboot.**

- SMS messages do not change the router configuration. They remain in effect only until the router is rebooted.

Serial communication is not working.

- Verify that the router model supports serial communications. Also verify the serial communication settings. To do so, open the router's configuration menu via the web browser, select the appropriate "Expansion Port" from "Configuration" part of the menu and verify the settings.

Is the router Cisco compatible? Can I use the Cisco configuration?

- No, the Firmware in the router (ICR-OS) is based on Linux with BusyBox. Thus the Cisco configuration cannot be used. But network connections are defined by standards so connecting the router to the Cisco or other networking devices is possible and will be compatible.

FTP or SFTP does not work

- FTP will work on v2 routers only. You can use SFTP on all routers to transfer files to/from the router. If having troubles with FTP on v2 routers, make sure you have FTP enabled: "Configuration" section, "Services", "FTP". Then you can connect with any client on port 21 with name and password same as for the Web interface. If having troubles with SFTP, make sure you have SSH enabled: "Configuration" section, "Services", "SSH". Then you can connect with any client on port 22 with name and password same as for the Web interface.

How can I connect to the router's command line? (SSH, Telnet)

- You can use SSH on all routers or Telnet on v2 routers only. SSH is enabled by default, but you can verify in Web interface in "Configuration" section, "Services", "SSH". Then connect with any SSH client on port 22 of the router. User and password is the same as for the Web interface. Telnet on v2 routers can be enabled here: "Configuration" section, "Services", "Telnet".

Appendix B: Customer Support

Customer Support for Europe

Advantech Czech s.r.o.

Sokolska 71
562 04, Usti nad Orlici
Czech Republic

Phone: +353 91 792444
Fax: +353 91 792445
E-mail: iiotcustomerservice@advantech.eu
Web: www.advantech.com

Customer Support for NAM

Advantech B+B SmartWorx

707 Dayton Road
Ottawa, IL 61350 USA

Phone: +1-800-346-3119 (Monday – Friday, 7 a.m. to 5:30 p.m. CST)
Fax: +1-815-433-5109
E-mail: support.iiot.ana@advantech.com
Web: www.advantech.com

Customer Support for Asia

Phone: +886-2-2792-7818 #1299 (Monday – Friday, 9 a.m. to 5:30 p.m. UTC+8)
Fax: +886-2-2794-7327
E-mail: icg.support@advantech.com.tw
Web: www.advantech.com

Appendix C: Regulatory & Safety Information

Safety Notices



Please, observe the following instructions:

- The router must adhere to all relevant international and national laws, including any specific restrictions governing its use in designated applications and environments.
- To prevent potential injury and appliance damage, ensure compliance with regulations by using only authorized accessories. Unauthorized modifications or use of unapproved accessories could damage the router, violate regulations, and void the warranty.
- Do not attempt to open the router.
- Before handling the SIM card, turn off the router and disconnect it from the power supply.
- **Caution!** This equipment is not suitable for use in areas with children. Small children could swallow the SIM card.
- Ensure the power supply does not exceed 48 V DC maximum.
- Avoid exposing the router to extreme ambient conditions. Safeguard it against dust, moisture, and high temperatures.
- Only deploy routers with appropriate certification and labeling in environments containing flammable or explosive materials, such as gas stations, chemical plants, or areas involving explosives. Users must observe restrictions pertaining to radio device usage in such settings.
- When traveling by plane, switch off the router. Using it onboard could jeopardize flight operations, disrupt mobile networks, and potentially violate regulations. Non-compliance may result in telephone service suspension, cancellation, or legal repercussions.
- Exercise heightened caution when operating the router near personal medical devices like cardiac pacemakers or hearing aids.
- The router may cause interference when operated in close proximity to TV sets, radio receivers, or personal computers.
- It's advisable to create a suitable backup of all critical settings stored in the device's memory.



Product Disposal Instructions

The WEEE (Waste Electrical and Electronic Equipment: 2012/19/EU) directive was introduced to ensure that electrical/electronic products are recycled using the best available recovery techniques to minimize the environmental impact. This product contains high quality materials and components which can be recycled. At the end of its life this product **MUST NOT** be mixed with other commercial waste for disposal. The device contains a battery. Remove the battery from the device before disposal. The battery in the device needs to be disposed of apart accordingly. Check the terms and conditions of your supplier for disposal information.

Appendix D: Related Documents

[1] [Configuration Manual for ICR-3200 Platform](#)



[EP] Product-related documents and applications can be obtained on **Engineering Portal** at <https://icr.advantech.com/download> address.