

# FCC Measurement/Technical Report on

## SmartFlex BL310

### Contains

FCC ID: Cellular: XMR201903EG25G

IC: Cellular: 10224A-201903EG25G

FCC ID: WiFi: Z64-WL18DBMOD

IC: WiFi: 451I-WL18DBMOD

**Test Report Reference:** MDE\_ADVANT\_2102\_FCC\_02

#### Test Laboratory:

7layers GmbH  
Borsigstrasse 11  
40880 Ratingen  
Germany



Deutsche  
Akkreditierungsstelle  
D-PL-12140-01-01  
D-PL-12140-01-02  
D-PL-12140-01-03

#### Note:

The following test results relate only to the devices specified in this document. This report shall not be reproduced in parts without the written approval of the test laboratory.

#### 7layers GmbH

Borsigstraße 11  
40880 Ratingen, Germany  
T +49 (0) 2102 749 0  
F +49 (0) 2102 749 350

Geschäftsführer/  
Managing Directors:  
Frank Spiller  
Bernhard Retka  
Alexandre Norré-Oudard

Registergericht/registered:  
Düsseldorf HRB 75554  
USt-Id.-Nr./VAT-No. DE203159652  
Steuer-Nr./TAX-No. 147/5869/0385

a Bureau Veritas  
Group Company

[www.7layers.com](http://www.7layers.com)

## Table of Contents

<b>1 Applied Standards and Test Summary</b>	<b>3</b>
1.1 Applied Standards	3
1.2 FCC-IC Correlation Table	4
1.3 Measurement Summary	4
<b>2 Revision History / Signatures</b>	<b>6</b>
<b>3 Administrative Data</b>	<b>7</b>
3.1 Testing Laboratory	7
3.2 Project Data	7
3.3 Applicant Data	7
3.4 Manufacturer Data	8
<b>4 Test object Data</b>	<b>9</b>
4.1 General EUT Description	9
4.2 EUT Main components	9
4.3 Ancillary Equipment	10
4.4 Auxiliary Equipment	10
4.5 EUT Setups	11
4.6 Operating Modes / Test Channels	11
4.7 Product labelling	11
<b>5 Test Results</b>	<b>12</b>
5.1 Conducted Emissions at AC mains	12
5.2 Radiated Emissions	15
<b>6 Test Equipment</b>	<b>23</b>
<b>7 Antenna Factors, Cable Loss and Sample Calculations</b>	<b>25</b>
7.1 LISN R&S ESH3-Z5 (150 kHz – 30 MHz)	25
7.2 Antenna R&S HFH2-Z2 (9 kHz – 30 MHz)	26
7.3 Antenna R&S HL562 (30 MHz – 1 GHz)	27
7.4 Antenna R&S HF907 (1 GHz – 18 GHz)	28
7.5 Antenna EMCO 3160-09 (18 GHz – 26.5 GHz)	29
7.6 Antenna EMCO 3160-10 (26.5 GHz – 40 GHz)	30
<b>8 Measurement Uncertainties</b>	<b>31</b>
<b>9 Photo Report</b>	<b>32</b>

## 1 APPLIED STANDARDS AND TEST SUMMARY

### 1.1 APPLIED STANDARDS

#### **Applicable FCC Rules**

Prepared in accordance with the requirements of FCC Rules and Regulations as listed in 47 CFR Ch.1 Parts 2 and 15 (10-1-20 Edition). The following subparts are applicable to the results in this test report.

#### **Part 2, Subpart J - Equipment Authorization Procedures, Certification**

#### **Part 15, Subpart B – Unintentional Radiators**

§ 15.107 Conducted limits

§ 15.109 Radiated emission limits; general requirements

#### **Applicable ISED Standards**

ICES-Gen, Issue 1

ICES-003, Issue 7

Note:

ANSI C63.4-2014 is applied.

## 1.2 FCC-IC CORRELATION TABLE

### Correlation of measurement requirements for Information Technology Equipment (ITE) from FCC and IC

Measurement	FCC reference	IC reference
Conducted Emissions (AC Power Line)	§15.107	ICES-003 Issue 7: 3.2.1
Radiated Spurious Emissions	§15.109	ICES-003 Issue 7: 3.2.2

#### Remarks:

1. FCC Part 15 subpart B, ICES 003 and CISPR 22 contain different definitions of Class A and Class B limits, i.e., which class is applicable to which kind of EUT.  
ICES 003 and CISPR 22 distinguish between the location where the EUT is intended to operate whilst FCC refers to the method of commercial distribution (distributive trades).
2. The correct assignment of the appropriate class to the concrete EUT is not scope of this test report!
3. A radio apparatus that is specifically subject to an Industry Canada Radio Standard Specification (RSS) and which contains an ITE is not subject to ICES-003 provided the ITE is used only to enable operation of the radio apparatus and the ITE does not control additional functions or capabilities.
4. ISM (Industrial, Scientific or Medical) radio frequency generators, though they may contain ITE, are excluded from the definition of ITE and are not subject to ICES-003. They are instead subject to the Interference-Causing Equipment Standard ICES-001, which specifically addresses ISM radio frequency generators.

### 1.3 MEASUREMENT SUMMARY

**47 CFR CHAPTER I FCC PART 15                      § 15.107 Class B**  
**Subpart B**

Conducted Emissions at AC mains

The measurement was performed according to ANSI C63.4

**Final Result**

<b>OP-Mode</b>	<b>Setup</b>	<b>Date</b>	<b>FCC</b>	<b>IC</b>
AC mains connection, Test setup via ancillary equipment, computer peripheral	S02_aa01	2022-02-04	Passed	Passed

**47 CFR CHAPTER I FCC PART 15                      § 15.109 Class B**  
**Subpart B**

Radiated Emissions

The measurement was performed according to ANSI C63.4

**Final Result**

<b>OP-Mode</b>	<b>Setup</b>	<b>Date</b>	<b>FCC</b>	<b>IC</b>
AC mains connection, Measurement range, Test setup via ancillary equipment, 30 MHz - 1 GHz, computer peripheral	S02_aa01	2022-02-01	Passed	Passed
via ancillary equipment, 1 GHz - 18 GHz, computer peripheral	S02_aa01	2022-01-31	Passed	Passed
via ancillary equipment, 18 GHz - 26 GHz, computer peripheral	S02_aa01	2022-02-10	Passed	Passed
via ancillary equipment, 26 GHz - 40GHz, computer peripheral	S02_aa01	2022-02-10	Passed	Passed

N/A: Not applicable

N/P: Not performed

## 2 REVISION HISTORY / SIGNATURES

Report version control			
Version	Release date	Change Description	Version validity
initial	2022-03-01	--	valid
--	--	--	--

COMMENT: -



(responsible for accreditation scope)  
Dipl.-Ing. Marco Kullik



(responsible for testing and report)  
B.Sc. Mohamed Fraitat



7 layers GmbH, Borsigstr. 11  
40880 Ratingen, Germany  
Phone +49 (0)2102 749 0

### 3 ADMINISTRATIVE DATA

#### 3.1 TESTING LABORATORY

Company Name: 7layers GmbH  
Address: Borsigstr. 11  
40880 Ratingen  
Germany

The test facility is accredited by the following accreditation organisation:

Laboratory accreditation no: DAKKS D-PL-12140-01-01 | -02 | -03  
FCC Designation Number: DE0015  
FCC Test Firm Registration: 929146  
ISED CAB Identifier: DE0007; ISED#: 3699A  
Responsible for accreditation scope: Dipl.-Ing. Marco Kullik  
Report Template Version: 2021-09-09

#### 3.2 PROJECT DATA

Responsible for testing and report: B.Sc. Mohamed Fraitat  
Employees who performed the tests: documented internally at 7Layers  
Date of Report: 2022-03-01  
Testing Period: 2022-01-31 to 2022-02-10

#### 3.3 APPLICANT DATA

Company Name: Advantech Czech s.r.o.  
Address: Sokolska 71  
562 04 Usti nad Orlici  
Czech Republic  
Contact Person: Eduard Dorskocil

### 3.4 MANUFACTURER DATA

Company Name: please see Applicant Data

Address:

Contact Person:



## 4 TEST OBJECT DATA

### 4.1 GENERAL EUT DESCRIPTION

Kind of Device product description	Industrial Cellular Router
Product name	SmartFlex
Type	BL310
<b>Declared EUT data by the supplier</b>	
Power Supply Type	AC over AC/DC Adapter (ANC 2) for 12 V DC at EUT
Test Voltage / Frequency	AC: 110-240 V, tested at 120V / 60Hz
Highest internal frequency	5825 MHz (WLAN 5 GHz Channel 165)
General Description	SmartFlex is a LTE cellular router designed for communication across cellular networks using LTE, HSPA+, UMTS, EDGE or GPRS technology. Data transfer speed is up to 100 Mbps (download) and up to 50 Mbps (upload). The router is an ideal solution for the wireless connection of traffic and security camera systems, individual computers, LANs, automatic teller machines (ATM), other self-service terminals, and many other devices.
Ports	<ul style="list-style-type: none"> <li>- Enclosure</li> <li>- external WiFi antenna, cable length 0 m (directly connected)</li> <li>- external DIV antenna, cable length 0 m (directly connected)</li> <li>- external Cellular antenna, cable length 0 m (directly connected)</li> <li>- external GNSS antenna, cable length 3 m</li> <li>- 2.0 USB cable, length 2 m, connected to AUX 1</li> <li>- Power cable, length 1.5 m, connected to ANC 2</li> <li>- shielded CAT-5e LAN cable, length 1.5 m, connected to AUX 2</li> </ul>

### 4.2 EUT MAIN COMPONENTS

Sample Name	Sample Code	Description
EUT B	DE1180009aa01	Radiated Sample
Sample Parameter	Value	
Serial No.	861861040754635	
HW Version	1.0	
SW Version	6.3.3	
Comment		

NOTE: The short description is used to simplify the identification of the EUT in this test report.

### 4.3 ANCILLARY EQUIPMENT

For the purposes of this test report, ancillary equipment is defined as equipment which is used in conjunction with the EUT to provide operational and control features to the EUT. It is necessary to configure the system in a typical fashion, as a customer would normally use it. But nevertheless Ancillary Equipment can influence the test results.

Device	Details (Manufacturer, Type Model, HW, SW, S/N)	Description
ANC 1	Advantech, LTE Antenna, -, -, P/N: BB-2JW0124Z-C868B	LTE Antenna (ANT/DIV)
ANC 2	Sunny Computer Technology Europe, SYS1561-1212, -, -, P/N: BB-RPS-v3-MO2-M	AC/DC Adapter
ANC 3	Advantech, WiFi Antenna, -, -, P/N: BB-AW-A2458G-FSRPK	WiFi Antenna
ANC 4	Advantech, AP-AGNSS-SMA, -, -, P/N: BB-AP-AGNSS-SMA	GNSS Antenna
ANC 5	-, CAT 5e shielded, -, -, P/N: BB-KD-ETH	Ethernet cross cable

### 4.4 AUXILIARY EQUIPMENT

For the purposes of this test report, auxiliary equipment is defined as equipment which is used temporarily to enable operational and control features especially used for the tests of the EUT which is not used during normal operation or equipment that is used during the tests in combination with the EUT but is not subject of this test report. It is necessary to configure the system in a typical fashion, as a customer would normally use it. But nevertheless Auxiliary Equipment can influence the test results.

Device	Details (Manufacturer, Type Model, HW, SW, S/N)	Description
AUX 1	SanDisk, cruze micro 1 GB, -, -, BB0701AFPB	USB Stick
AUX 2	Fujitsu, Lifebook E Series U758, 2018-06, Win10 Pro Engl., DSAL006396	Laptop
AUX 3	Fujitsu, A13-065N3A, -, -, 184903C604	AC/DC Adapter for laptop
AUX 4	Logitech, M-BT58, -, -, HC60915A2XC	Mouse
AUX 5	Cherry, RS 6000 USB ON, -, -, G 0000273 2P28	Keyboard
AUX 6	LG, L17MB-P, -, -, 412WAPL0U560	Monitor

## 4.5 EUT SETUPS

This chapter describes the combination of EUTs and equipment used for testing. The rationale for selecting the EUTs, ancillary and auxiliary equipment and interconnecting cables, is to test a representative configuration meeting the requirements of the referenced standards.

<b>Setup</b>	<b>Combination of EUTs</b>	<b>Description and Rationale</b>
S02_aa01	EUT B + ANC 1 to ANC 5 + AUX 1 to AUX 6	Setup for FCC 15b

## 4.6 OPERATING MODES / TEST CHANNELS

This chapter describes the operating modes of the EUTs used for testing.

Active operating modes during tests:

- LAN Ping
- USB traffic
- LTE eFDD 5 idle mode
- WLAN on standby

## 4.7 PRODUCT LABELLING

### 4.7.1 FCC ID LABEL

Please refer to the documentation of the applicant.

### 4.7.2 LOCATION OF THE LABEL ON THE EUT

Please refer to the documentation of the applicant.

## 5 TEST RESULTS

### 5.1 CONDUCTED EMISSIONS AT AC MAINS

Standard **FCC Part 15 Subpart B**

**The test was performed according to:**  
ANSI C63.4

#### 5.1.1 TEST DESCRIPTION

The test set-up was made in accordance to the general provisions of ANSI C 63.4. The Equipment Under Test (EUT) was setup in a shielded room to perform the conducted emissions measurements in a typical installation configuration. The EUT was powered from 50 $\mu$ H || 50 Ohm Line Impedance Stabilization Network (LISN). The LISN's unused connections were terminated with 50 Ohm loads.

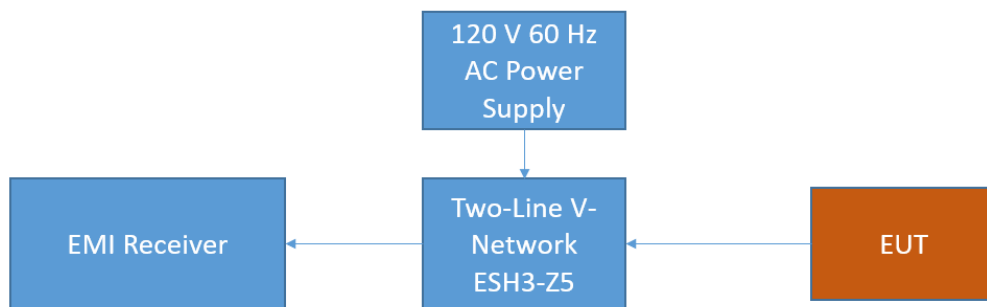

FCC Conducted Emissions on AC

The measurement procedure consists of two steps. It is implemented into the EMI test software EMC-32 from R&S.

#### **Step 1: Preliminary scan**

Intention of this step is, to determine the conducted EMI-profile of the EUT.

EMI receiver settings:

- Detector: Peak – Maxhold & Average
- Frequency range: 150 kHz – 30 MHz
- Frequency steps: 2.5 kHz
- IF-Bandwidth: 9 kHz
- Measuring time / Frequency step: 100 ms (FFT-based)
- Measurement on phase + neutral lines of the power cords

On basis of this preliminary scan the highest amplitudes and the corresponding frequencies relative to the limit are identified. Emissions above the limit and emissions which are in the 10 dB range below the limit are considered.

## Step 2: Final measurement

Intention of this step is, to determine the highest emissions with the settings defined in the test specification for the frequencies identified in step 1.

EMI receiver settings:

- Detector: Quasi-Peak & (CISPR) Average
- IF Bandwidth: 9 kHz
- Measuring time: 1 s / frequency

At each frequency determined in step 1, four measurements are performed in the following combinations:

- 1) Neutral lead - reference ground (PE grounded)
- 2) Phase lead - reference ground (PE grounded)
- 3) Neutral lead - reference ground (PE floating)
- 4) Phase lead - reference ground (PE floating)

The highest value is reported.

### 5.1.2 TEST REQUIREMENTS / LIMITS

FCC Part 15, Subpart B, §15.107

#### Class B:

Frequency (MHz)	QP Limits (dB $\mu$ V)	AV Limits (dB $\mu$ V)
0.15 - 0.5	66 - 56	56 - 46
0.5 - 5	56	46
5 - 30	60	50

#### Class A:

Frequency (MHz)	QP Limits (dB $\mu$ V)	AV Limits (dB $\mu$ V)
0.15 - 0.5	79	66
0.5 - 30	73	60

### 5.1.3 TEST PROTOCOL

Temperature: 22 °C  
 Air Pressure: 1010 hPa  
 Humidity: 33 %  
 via ancillary equipment, computer peripheric

Power line	PE	Frequency [MHz]	Level [dB $\mu$ V]	Detector	Limit [dB $\mu$ V]	Margin [dB]
L1	GND	0.51	38.4	AV	46.0	7.6
L1	FLO	0.52	42.8	QP	56.0	13.2

Remark: Please see next sub-clause for the measurement plot.

### 5.1.4 MEASUREMENT PLOT (EXAMPLE PLOT, SHOWING WORST CASE, IF APPLICABLE)

AC mains connection = via ancillary equipment, Test setup = computer peripheral (S02\_aa01)

#### Common Information

Test Description:	Conducted Emissions
Test Standard:	FCC §15.107, ANSI C63.4
EUT / Setup Code:	DE1180009aa01 - SmartFlex RL310
Operating Conditions:	LTE eFDD5 idle mode; LAN traffic; USB traffic, WLAN Standby
Operator Name:	URO
Comment:	Computer Peripheral Setup, AC/DC-Adapter, 120 V / 60 Hz
Legend:	Trace: blue = QP, green = CISPR AV; Star: red or blue = critical frequency; Rhombus: blue = final QP, green = final CISPR AV
Tested Port / used LISN:	AC mains => 1st LISN ESH3-Z5
Termination of other ports:	AC of AUX => 2nd LISN ESH3-Z5 +50 Ohm

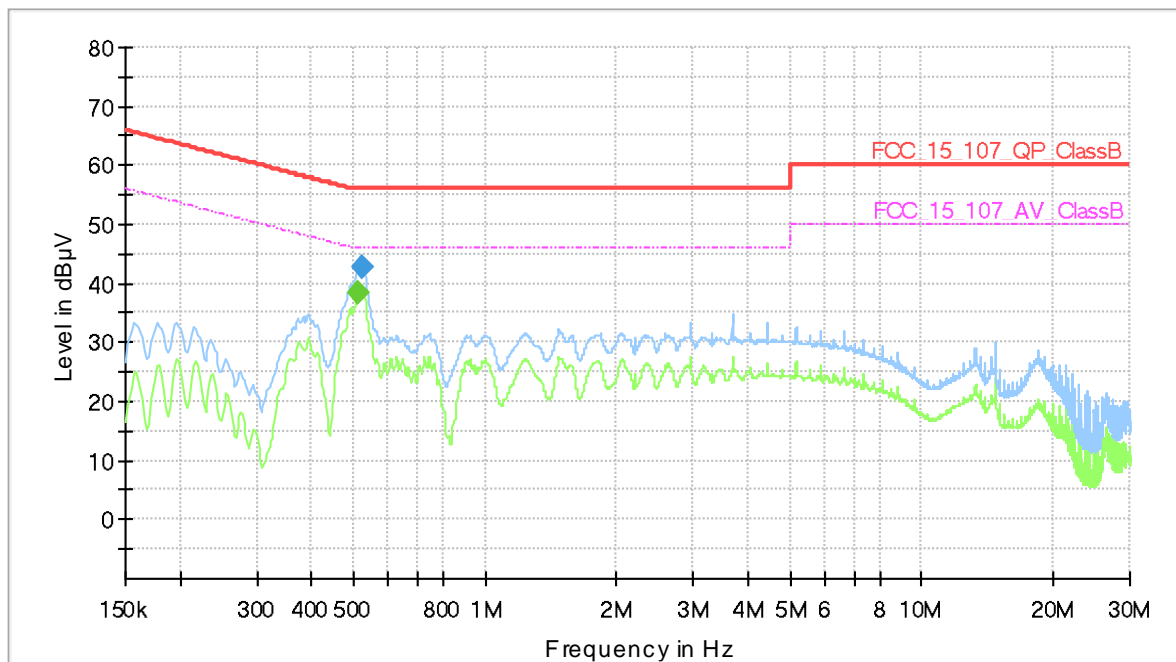

#### Final Result

Frequency (MHz)	QuasiPeak (dBµV)	CAverage (dBµV)	Limit (dBµV)	Margin (dB)	Meas. Time (ms)	Bandwidth (kHz)	Line	PE	Corr. (dB)
0.512250	---	38.42	46.00	7.58	1000.0	9.000	L1	GND	10.1
0.523500	42.80	---	56.00	13.20	1000.0	9.000	L1	FLO	10.1

### 5.1.5 TEST EQUIPMENT USED

- Conducted Emissions FCC

## 5.2 RADIATED EMISSIONS

Standard **FCC Part 15 Subpart B**

**The test was performed according to:**  
ANSI C63.4

### 5.2.1 TEST DESCRIPTION

The test set-up was made in accordance to the general provisions of ANSI C63.4 in a typical installation configuration. The measurements were performed according to the following sub-chapters of ANSI C63.4:

- 30 MHz – 1 GHz: Chapter 8.3.2.1
- > 1 GHz: Chapter 8.3.2.2

The measurement procedure is implemented into the EMI test software EMC32 from R&S. Exploratory tests are performed at 3 orthogonal axes to determine the worst-case orientation of a body-worn or handheld EUT. The final test on all kind of EUTs is also performed at 3 axes. A pre-check is performed while the EUT is powered.

The Equipment Under Test (EUT) was set up on a non-conductive table in the semi-anechoic chamber. The influence of the EUT support table that is used between 30–1000 MHz was evaluated.

### 1. Measurement setup

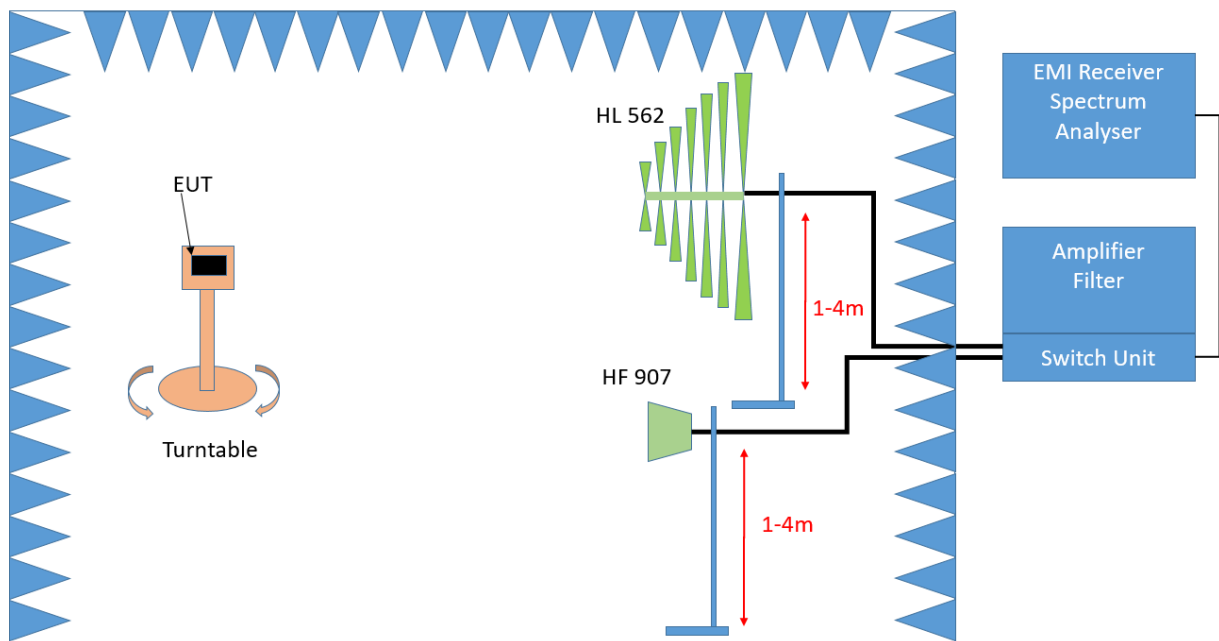

Test Setup; Spurious Emission Radiated (SAC)

## Frequency range 30 MHz – 1 GHz

### Step 1: Preliminary scan

This is a preliminary test to identify the highest amplitudes relative to the limit.

Settings for step 1:

- Antenna distance: 3 m
- Detector: Peak-Maxhold / Quasipeak (FFT-based)
- Frequency range: 30 – 1000 MHz
- Frequency steps: 30 kHz
- IF-Bandwidth: 120 kHz
- Measuring time / Frequency step: 100 ms
- Turntable angle range:  $-180^{\circ}$  to  $90^{\circ}$
- Turntable step size:  $90^{\circ}$
- Height variation range: 1 – 4 m
- Height variation step size: 1.5 m
- Polarisation: Horizontal + Vertical

Intention of this step is, to determine the radiated EMI-profile of the EUT. Afterwards the relevant emissions for the final measurement are identified.

### Step 2: Adjustment measurement

In this step the accuracy of the turntable azimuth and antenna height will be improved. This is necessary to find out the maximum value of every frequency.

For each frequency, which was determined the turntable azimuth and antenna height will be adjusted. The turntable azimuth will slowly vary by  $360^{\circ}$ . During this action, the value of emission is continuously measured. The turntable azimuth at the highest emission will be recorded and adjusted. In this position, the antenna height will slowly vary between 1 – 4 m. During this action, the value of emission is also continuously measured. The antenna height of the highest emission will also be recorded and adjusted.

- Detector: Peak – Maxhold
- Measured frequencies: in step 1 determined frequencies
- IF – Bandwidth: 120 kHz
- Measuring time: 100 ms
- Turntable angle range:  $360^{\circ}$
- Height variation range: 1 – 4 m
- Antenna Polarisation: max. value determined in step 1

### Step 3: Final measurement with QP detector

With the settings determined in step 2, the final measurement will be performed:

EMI receiver settings for step 3:

- Detector: Quasi-Peak
- Measured frequencies: in step 1 determined frequencies
- IF – Bandwidth: 120 kHz
- Measuring time: 1 s



### **Above 1 GHz:**

The following changes apply to the measurement procedure for the frequency range > 1 GHz:

#### **Step 1:**

- Turntable step size: 45°
- Detector: Peak, Average (Maxhold)
- IF – Bandwidth: 1 MHz
- Frequency steps: 250 kHz
- Measuring time: 500 ms / GHz

#### **Step 2:**

- IF – Bandwidth: 1 MHz

#### **Step 3:**

- Detector: Peak / CISPR Average
- IF – Bandwidth: 1 MHz

After every measurement a plot will be generated which contains a diagram with the results of the preliminary scan and a chart with the frequencies and values of the results of the final measurement.

## 5.2.2 TEST REQUIREMENTS / LIMITS

FCC Part 15, Subpart B, §15.109, Radiated Emission Limits

### Class B:

Frequency (MHz)	Limit (µV/m)	Measurement distance (m)	Limits (dBµV/m)
30 – 88	100@3m	3	40.0@3m
88 – 216	150@3m	3	43.5@3m
216 – 960	200@3m	3	46.0@3m
960 - 26000	500@3m	3	54.0@3m
26000 - 40000	500@3m	1	54.0@3m

### Class A:

Frequency (MHz)	Limit (µV/m)	Measurement distance (m)	Limits (dBµV/m)
30 – 88	90@10m	3	39.1@10m
88 – 216	150@10m	3	43.5@10m
216 – 960	210@10m	3	46.4@10m
960 - 26000	300@10m	3	49.5@10m
26000 - 40000	300@10m	1	49.5@10m

The measured values for Class A and for Class B (> 26 GHz) measurements are corrected with an inverse linear distance extrapolation factor (20 dB/decade).

§15.35(b) ..., there is also a limit on the radio frequency emissions, as measured using instrumentation with a peak detector function, corresponding to 20 dB above the maximum permitted average limit....

Used conversion factor:  $\text{Limit (dB}\mu\text{V/m)} = 20 \log (\text{Limit } (\mu\text{V/m})/1\mu\text{V/m})$

## 5.2.3 TEST PROTOCOL

Ambient temperature: 22–23 °C  
 Air Pressure: 1002–1007 hPa  
 Humidity: 33–38 %  
 via ancillary equipment, computer peripheric

Spurious Freq. [MHz]	Spurious Level [dBµV/m]	Detector	RBW [kHz]	Limit [dBµV/m]	Margin to Limit [dB]
31.2	32.7	QP	120	40.0	7.3
32.3	32.1	QP	120	40.0	7.9
36.0d	30.8	QP	120	40.0	9.2
152.3	30.0	QP	120	43.5	13.5
237.8	11.8	QP	120	46.0	34.2
240.0	13.2	QP	120	46.0	32.8
550.0	39.3	QP	120	46.0	6.7
720.1	15.7	QP	120	46.0	30.3
25373.6	53.2	PEAK	1000	74.0	20.8
25360.8	40.4	AV	1000	54.0	13.6

Remark: Please see next sub-clause for the measurement plot.

### 5.2.4 MEASUREMENT PLOT (EXAMPLE PLOT, SHOWING WORST CASE, IF APPLICABLE)

AC mains connection = via ancillary equipment, Measurement range = 30 MHz - 1 GHz,  
 Test setup = computer peripheral  
 (S02\_aa01)

#### Common Information

Test Description:	Radiated Emissions, Test Site: Semi Anechoic Chamber @ 3 m
Test Standard:	FCC 15 B Class B
EUT / Setup Code:	DE1180009aa01 – SmartFlex BL310
Operating Conditions:	LTE eFDD5 idle mode; LAN traffic; USB traffic, WLAN Standby
Operator Name:	MER
Comment:	Computer Peripheral Setup, AC/DC-Adapter, 120 V / 60 Hz
Legend:	Trace (preview): blue = PK, green = QP; Star: red or blue = critical frequency; Rhombus: blue = final QP

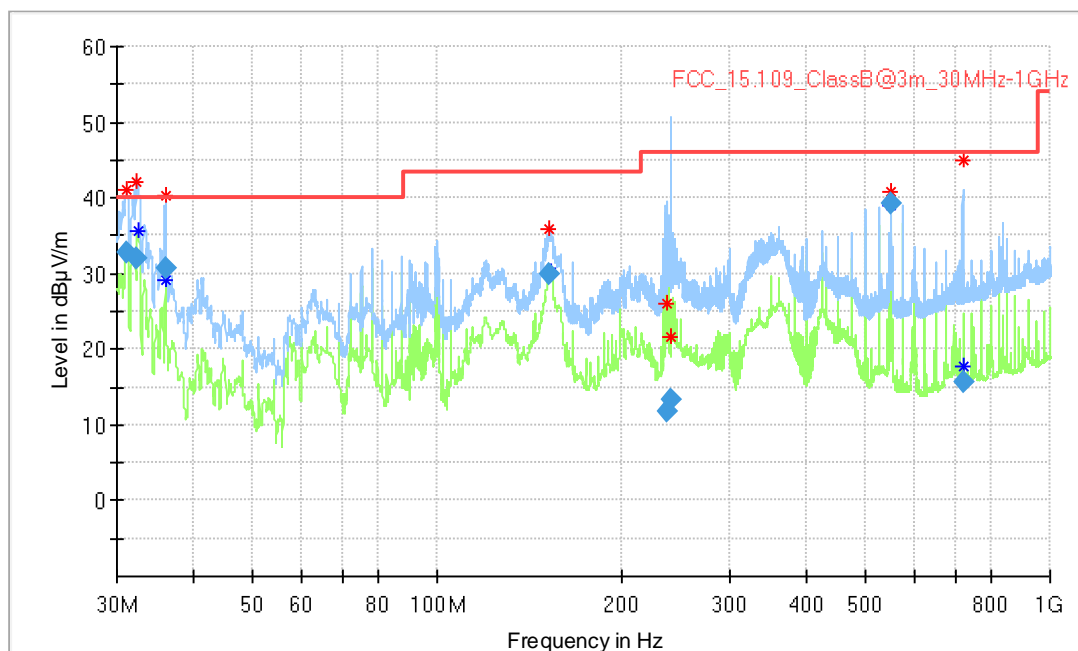

#### Final\_Result

Frequency (MHz)	QuasiPeak (dBµV/m)	Limit (dBµV/m)	Margin (dB)	Meas. Time (ms)	Bandwidth (kHz)	Height (cm)	Pol	Azimuth (deg)	Corr. (dB/m)
31.200000	32.70	40.00	7.30	1000.0	120.000	103.0	V	-51.0	18.4
32.310000	32.11	40.00	7.89	1000.0	120.000	115.0	V	-91.0	17.8
36.030000	30.82	40.00	9.18	1000.0	120.000	104.0	V	-192.0	15.8
152.340000	30.03	43.50	13.47	1000.0	120.000	105.0	V	-167.0	9.2
237.840000	11.79	46.00	34.21	1000.0	120.000	340.0	V	45.0	11.4
240.030000	13.24	46.00	32.76	1000.0	120.000	366.0	V	40.0	11.5
549.990000	39.30	46.00	6.70	1000.0	120.000	100.0	H	-125.0	19.7
720.060000	15.74	46.00	30.26	1000.0	120.000	156.0	V	45.0	22.7

AC mains connection = via ancillary equipment, Measurement range = 1 GHz - 18 GHz,  
Test setup = computer peripheral  
(S02\_aa01)

### Common Information

Test Description:	Radiated Emissions @ 3 m, SAC + mobile floor absorber
Test Standard:	FCC 15 B Class B
EUT / Setup Code:	DE1180009aa01 - SmartFlex BL310
Operating Conditions:	LTE eFDD5 idle mode; LAN traffic; USB traffic, WLAN Standby
Operator Name:	TWA
Comment:	Computer Peripheral Setup, AC/DC-Adapter, 120 V / 60 Hz
Legend:	Trace (preview): blue = PK, green = AV; Star: red or blue = critical frequency; Rhombus: blue = final Peak, green = Final CISPR AV

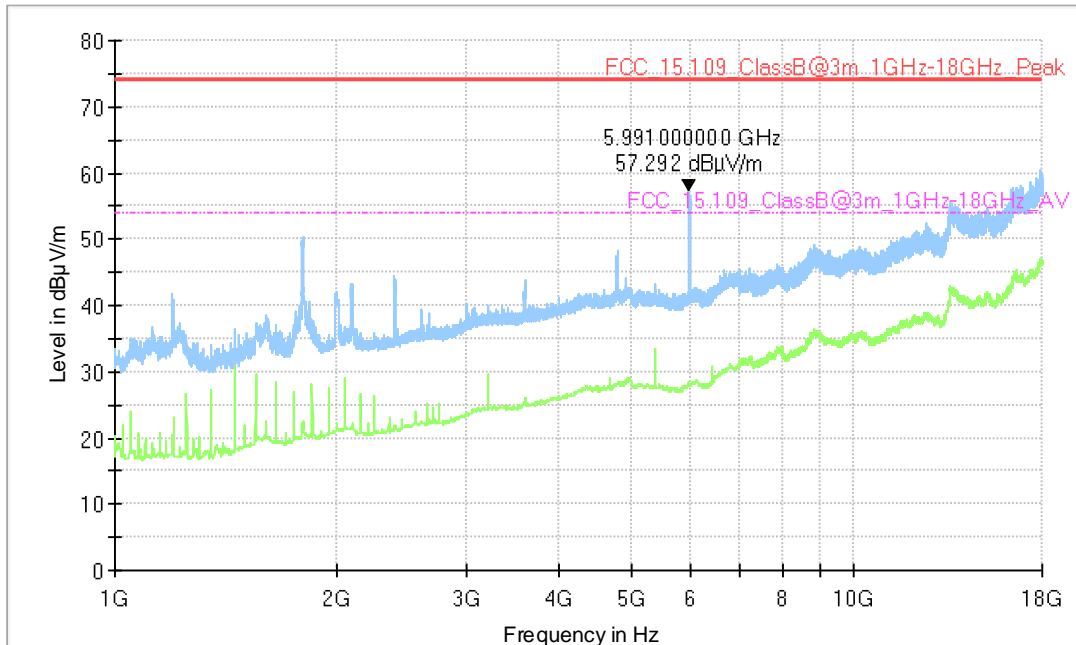

### Final\_Result

Frequency (MHz)	MaxPeak (dBµV/m)	CAverage (dBµV/m)	Limit (dBµV/m)	Margin (dB)	Meas. Time (ms)	Bandwidth (kHz)	Height (cm)	Pol	Azimuth (deg)	Corr. (dB/m)
---	---	---	---	---	---	---	---	---	---	---

AC mains connection = via ancillary equipment, Measurement range = 18 GHz - 26 GHz,  
 Test setup = computer peripheral  
 (S02\_aa01)

### Common Information

Test Description:	Radiated Emissions @ 3 m
Test Standard:	FCC 15 B Class B
EUT / Setup Code:	DE1180009aa01 - SmartFlex BL310
Operating Conditions:	LTE eFDD5 idle mode; LAN traffic; USB traffic, WLAN Standby
Operator Name:	TWA
Comment:	Computer Peripheral Setup, AC/DC-Adapter, 120 V / 60 Hz
Legend:	Trace (preview): blue = PK, green = AV; Star: red or blue = critical frequency; Rhombus: blue = final Peak, green = Final CISPR AV

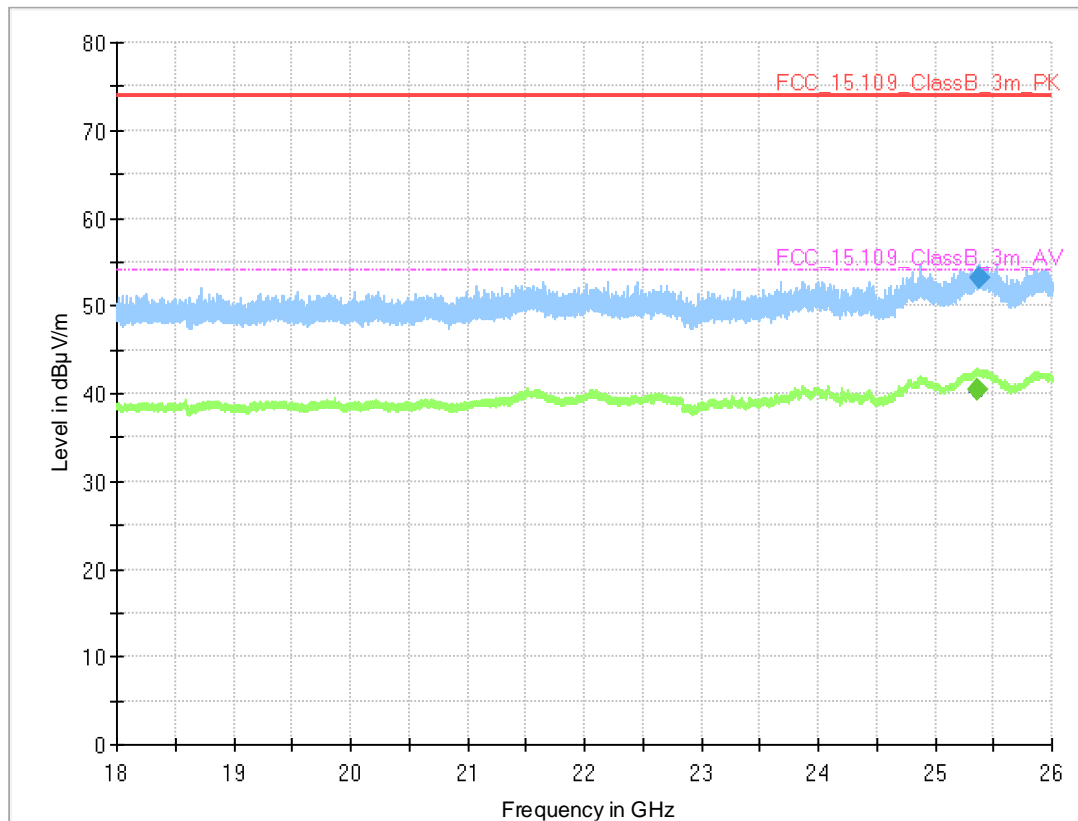

### Final Result

Frequency (MHz)	MaxPeak (dBµV/m)	CAverage (dBµV/m)	Limit (dBµV/m)	Margin (dB)	Meas. Time (ms)	Bandwidth (kHz)	Height (cm)	Pol	Azimuth (deg)	Corr. (dB/m)
25360.800	---	40.4	54.00	13.58	1000.0	1000.000	150.0	H	3.0	20.9
25373.600	53.2	---	74.00	20.80	1000.0	1000.000	150.0	H	-39.0	20.8

AC mains connection = via ancillary equipment, Measurement range = 26 GHz - 40 GHz,  
Test setup = computer peripheral  
(S02\_aa01)

### Common Information

Test Description:	Radiated Emissions @ 1 m
Test Standard:	FCC 15 B Class B
EUT / Setup Code:	DE1180009aa01 - SmartFlex BL310
Operating Conditions:	LTE eFDD5 idle mode; LAN traffic; USB traffic, WLAN Standby
Operator Name:	TWA
Comment:	Computer Peripheral Setup, AC/DC-Adapter, 120 V / 60 Hz
Legend:	Trace (preview): blue = PK, green = AV; Star: red or blue = critical frequency; Rhombus: blue = final Peak, green = Final CISPR AV

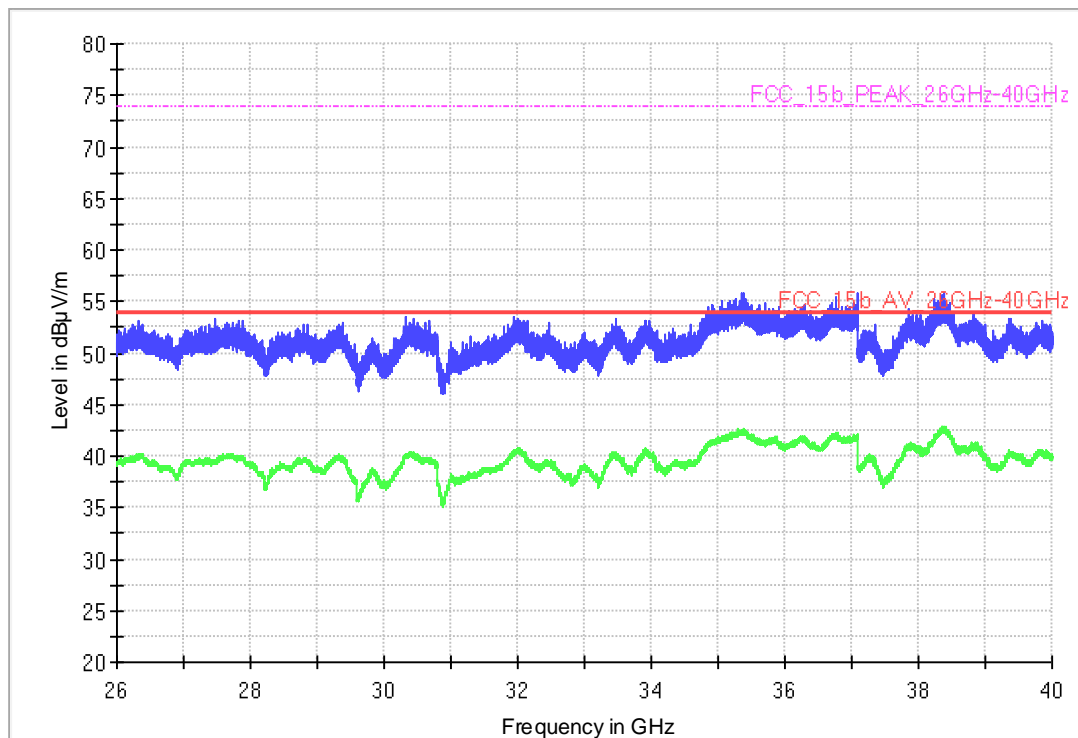

### Final Result

Frequency (MHz)	MaxPeak (dBμV/m)	CAverage (dBμV/m)	Limit (dBμV/m)	Margin (dB)	Meas. Time (ms)	Bandwidth (kHz)	Height (cm)	Pol	Azimuth (deg)	Corr. (dB/m)
---	---	---	---	---	---	---	---		---	---

### 5.2.5 TEST EQUIPMENT USED

- Radiated Emissions SAC below 1 GHz
- Radiated Emissions SAC above 1 GHz

## 6 TEST EQUIPMENT

- 1 Conducted Emissions FCC  
Conducted Emissions AC Mains for FCC standards

Ref.No.	Device Name	Description	Manufacturer	Serial Number	Last Calibration	Calibration Due
1.1	MFS	Rubidium Frequency Normal MFS	Datum GmbH	002	2021-11	2022-11
1.2	Opus10 TPR (8253.00)	T/P Logger 13	Lufft Mess- und Regeltechnik GmbH	13936	2021-10	2023-10
1.3	ESH3-Z5	Two-Line V-Network (AUX)	Rohde & Schwarz GmbH & Co. KG	828304/029	2021-08	2023-08
1.4	Chroma 6404	AC Source	Chroma ATE INC.	64040001304		
1.5	CMW500	Callbox OIL-RE, SUW	Rohde & Schwarz GmbH & Co. KG	155999-Ei	2019-09	2022-09
1.6	Shielded Room 02	Shielded Room 4m x 3m	Frankonia Germany EMC Solution GmbH	-		
1.7	ESH3-Z5	Two-Line V-Network (EUT)	Rohde & Schwarz GmbH & Co. KG	829996/002	2021-08	2023-08
1.8	ESR 7	EMI Receiver / Spectrum Analyzer	Rohde & Schwarz	101424	2021-01	2023-01
1.9	Opus10 THI (8152.00)	T/H Logger 02	Lufft Mess- und Regeltechnik GmbH	7489	2021-10	2023-10

- 2 Radiated Emissions SAC above 1 GHz  
Radiated emission tests above 1 GHz in a semi anechoic room with floor absorbers

Ref.No.	Device Name	Description	Manufacturer	Serial Number	Last Calibration	Calibration Due
2.1	Opus10 TPR (8253.00)	T/P Logger 13	Lufft Mess- und Regeltechnik GmbH	13936	2021-10	2023-10
2.2	ESW44	EMI Receiver / Spectrum Analyzer	Rohde & Schwarz GmbH & Co. KG	101603	2022-01	2024-01
2.3	Anechoic Chamber 01	SAC/FAR, 10.58 m x 6.38 m x 6.00 m	Frankonia	none		
2.4	Opus10 THI (8152.00)	T/H Logger 10	Lufft Mess- und Regeltechnik GmbH	12488	2021-08	2023-08
2.5	EP 1200/B, NA/B1	AC Source, Amplifier with integrated variable Oscillator	Spitzenberger & Spies GmbH & Co. KG	B6278		
2.6	DS 420S	Turn Table 2 m diameter	HD GmbH	420/573/99		
2.7	JS4-00102600-42-5A	Broadband Amplifier 30 MHz - 26 GHz	Miteq	619368		
2.8	MA4985-XP-ET	Bore Sight Antenna Mast	innco systems GmbH	none		
2.9	BB4312-C30-H3x	Filter Universal 1A	Siemens Matsushita Components	none		
2.10	HF 907-2	Double-ridged horn	Rohde & Schwarz	102817	2019-04	2022-04

3 Radiated Emissions SAC up to 1 GHz  
Radiated emission tests up to 1 GHz in a semi anechoic room

Ref.No.	Device Name	Description	Manufacturer	Serial Number	Last Calibration	Calibration Due
3.1	Opus10 TPR (8253.00)	T/P Logger 13	Lufft Mess- und Regeltechnik GmbH	13936	2021-10	2023-10
3.2	ESW44	EMI Receiver / Spectrum Analyzer	Rohde & Schwarz GmbH & Co. KG	101603	2022-01	2024-01
3.3	Anechoic Chamber 01	SAC/FAR, 10.58 m x 6.38 m x 6.00 m	Frankonia	none		
3.4	HL 562 ULTRALOG	Biconical-log-per antenna (30 MHz - 3 GHz) with HL 562E biconicals	Rohde & Schwarz GmbH & Co. KG	830547/003	2021-09	2024-09
3.5	Opus10 THI (8152.00)	T/H Logger 10	Lufft Mess- und Regeltechnik GmbH	12488	2021-08	2023-08
3.6	EP 1200/B, NA/B1	AC Source, Amplifier with integrated variable Oscillator	Spitzenberger & Spies GmbH & Co. KG	B6278		
3.7	DS 420S	Turn Table 2 m diameter	HD GmbH	420/573/99		
3.8	AM 4.0	Antenna Mast 4 m	Maturo GmbH	AM4.0/180/11920513		
3.9	3160-10	Standard Gain / Pyramidal Horn Antenna 40 GHz	EMCO Elektronik GmbH	00086675		

The calibration interval is the time interval between "Last Calibration" and "Calibration Due"



## 7 ANTENNA FACTORS, CABLE LOSS AND SAMPLE CALCULATIONS

This chapter contains the antenna factors with their corresponding path loss of the used measurement path for all antennas as well as the insertion loss of the LISN.

### 7.1 LISN R&S ESH3-Z5 (150 KHZ – 30 MHZ)

Frequency MHz	Corr. dB	LISN insertion loss ESH3- Z5 dB	cable loss (incl. 10 dB atten- uator) dB
0.15	10.1	0.1	10.0
5	10.3	0.1	10.2
7	10.5	0.2	10.3
10	10.5	0.2	10.3
12	10.7	0.3	10.4
14	10.7	0.3	10.4
16	10.8	0.4	10.4
18	10.9	0.4	10.5
20	10.9	0.4	10.5
22	11.1	0.5	10.6
24	11.1	0.5	10.6
26	11.2	0.5	10.7
28	11.2	0.5	10.7
30	11.3	0.5	10.8

#### Sample calculation

$$U_{\text{LISN}} (\text{dB } \mu\text{V}) = U (\text{dB } \mu\text{V}) + \text{Corr. (dB)}$$

U = Receiver reading

LISN Insertion loss = Voltage Division Factor of LISN

Corr. = sum of single correction factors of used LISN, cables, switch units (if used)

Linear interpolation will be used for frequencies in between the values in the table.

## 7.2 ANTENNA R&S HFH2-Z2 (9 KHZ – 30 MHZ)

Frequency MHz	AF HFH-Z2) dB (1/m)	Corr. dB	cable loss 1 (inside chamber) dB	cable loss 2 (outside chamber) dB	cable loss 3 (switch unit) dB	cable loss 4 (to receiver) dB	distance corr. (-40 dB/ decade) dB	d <sub>Limit</sub> (meas. distance (limit) m	d <sub>used</sub> (meas. distance (used) m
0.009	20.50	-79.6	0.1	0.1	0.1	0.1	-80	300	3
0.01	20.45	-79.6	0.1	0.1	0.1	0.1	-80	300	3
0.015	20.37	-79.6	0.1	0.1	0.1	0.1	-80	300	3
0.02	20.36	-79.6	0.1	0.1	0.1	0.1	-80	300	3
0.025	20.38	-79.6	0.1	0.1	0.1	0.1	-80	300	3
0.03	20.32	-79.6	0.1	0.1	0.1	0.1	-80	300	3
0.05	20.35	-79.6	0.1	0.1	0.1	0.1	-80	300	3
0.08	20.30	-79.6	0.1	0.1	0.1	0.1	-80	300	3
0.1	20.20	-79.6	0.1	0.1	0.1	0.1	-80	300	3
0.2	20.17	-79.6	0.1	0.1	0.1	0.1	-80	300	3
0.3	20.14	-79.6	0.1	0.1	0.1	0.1	-80	300	3
0.49	20.12	-79.6	0.1	0.1	0.1	0.1	-80	300	3
0.490001	20.12	-39.6	0.1	0.1	0.1	0.1	-40	30	3
0.5	20.11	-39.6	0.1	0.1	0.1	0.1	-40	30	3
0.8	20.10	-39.6	0.1	0.1	0.1	0.1	-40	30	3
1	20.09	-39.6	0.1	0.1	0.1	0.1	-40	30	3
2	20.08	-39.6	0.1	0.1	0.1	0.1	-40	30	3
3	20.06	-39.6	0.1	0.1	0.1	0.1	-40	30	3
4	20.05	-39.5	0.2	0.1	0.1	0.1	-40	30	3
5	20.05	-39.5	0.2	0.1	0.1	0.1	-40	30	3
6	20.02	-39.5	0.2	0.1	0.1	0.1	-40	30	3
8	19.95	-39.5	0.2	0.1	0.1	0.1	-40	30	3
10	19.83	-39.4	0.2	0.1	0.2	0.1	-40	30	3
12	19.71	-39.4	0.2	0.1	0.2	0.1	-40	30	3
14	19.54	-39.4	0.2	0.1	0.2	0.1	-40	30	3
16	19.53	-39.3	0.3	0.1	0.2	0.1	-40	30	3
18	19.50	-39.3	0.3	0.1	0.2	0.1	-40	30	3
20	19.57	-39.3	0.3	0.1	0.2	0.1	-40	30	3
22	19.61	-39.3	0.3	0.1	0.2	0.1	-40	30	3
24	19.61	-39.3	0.3	0.1	0.2	0.1	-40	30	3
26	19.54	-39.3	0.3	0.1	0.2	0.1	-40	30	3
28	19.46	-39.2	0.3	0.1	0.3	0.1	-40	30	3
30	19.73	-39.1	0.4	0.1	0.3	0.1	-40	30	3

### Sample calculation

$$E \text{ (dB } \mu\text{V/m)} = U \text{ (dB } \mu\text{V)} + AF \text{ (dB 1/m)} + Corr. \text{ (dB)}$$

U = Receiver reading

AF = Antenna factor

Corr. = sum of single correction factors of used cables, switch unit, distance correction, amplifier (if applicable)

distance correction =  $-40 * \text{LOG} (d_{\text{Limit}} / d_{\text{used}})$

Linear interpolation will be used for frequencies in between the values in the table.

Table shows an extract of values

### 7.3 ANTENNA R&S HL562 (30 MHz – 1 GHz)

( $d_{Limit} = 3\text{ m}$ )

Frequency	AF R&S HL562	Corr.
MHz	dB (1/m)	dB
30	18.6	0.6
50	6.0	0.9
100	9.7	1.2
150	7.9	1.6
200	7.6	1.9
250	9.5	2.1
300	11.0	2.3
350	12.4	2.6
400	13.6	2.9
450	14.7	3.1
500	15.6	3.2
550	16.3	3.5
600	17.2	3.5
650	18.1	3.6
700	18.5	3.6
750	19.1	4.1
800	19.6	4.1
850	20.1	4.4
900	20.8	4.7
950	21.1	4.8
1000	21.6	4.9

cable loss 1 (inside chamber)	cable loss 2 (outside chamber)	cable loss 3 (switch unit)	cable loss 4 (to receiver)	distance corr. (-20 dB/ decade)	$d_{Limit}$ (meas. distance (limit))	$d_{used}$ (meas. distance (used))
dB	dB	dB	dB	dB	m	m
0.29	0.04	0.23	0.02	0.0	3	3
0.39	0.09	0.32	0.08	0.0	3	3
0.56	0.14	0.47	0.08	0.0	3	3
0.73	0.20	0.59	0.12	0.0	3	3
0.84	0.21	0.70	0.11	0.0	3	3
0.98	0.24	0.80	0.13	0.0	3	3
1.04	0.26	0.89	0.15	0.0	3	3
1.18	0.31	0.96	0.13	0.0	3	3
1.28	0.35	1.03	0.19	0.0	3	3
1.39	0.38	1.11	0.22	0.0	3	3
1.44	0.39	1.20	0.19	0.0	3	3
1.55	0.46	1.24	0.23	0.0	3	3
1.59	0.43	1.29	0.23	0.0	3	3
1.67	0.34	1.35	0.22	0.0	3	3
1.67	0.42	1.41	0.15	0.0	3	3
1.87	0.54	1.46	0.25	0.0	3	3
1.90	0.46	1.51	0.25	0.0	3	3
1.99	0.60	1.56	0.27	0.0	3	3
2.14	0.60	1.63	0.29	0.0	3	3
2.22	0.60	1.66	0.33	0.0	3	3
2.23	0.61	1.71	0.30	0.0	3	3

( $d_{Limit} = 10\text{ m}$ )

30	18.6	-9.9
50	6.0	-9.6
100	9.7	-9.2
150	7.9	-8.8
200	7.6	-8.6
250	9.5	-8.3
300	11.0	-8.1
350	12.4	-7.9
400	13.6	-7.6
450	14.7	-7.4
500	15.6	-7.2
550	16.3	-7.0
600	17.2	-6.9
650	18.1	-6.9
700	18.5	-6.8
750	19.1	-6.3
800	19.6	-6.3
850	20.1	-6.0
900	20.8	-5.8
950	21.1	-5.6
1000	21.6	-5.6

0.29	0.04	0.23	0.02	-10.5	10	3
0.39	0.09	0.32	0.08	-10.5	10	3
0.56	0.14	0.47	0.08	-10.5	10	3
0.73	0.20	0.59	0.12	-10.5	10	3
0.84	0.21	0.70	0.11	-10.5	10	3
0.98	0.24	0.80	0.13	-10.5	10	3
1.04	0.26	0.89	0.15	-10.5	10	3
1.18	0.31	0.96	0.13	-10.5	10	3
1.28	0.35	1.03	0.19	-10.5	10	3
1.39	0.38	1.11	0.22	-10.5	10	3
1.44	0.39	1.20	0.19	-10.5	10	3
1.55	0.46	1.24	0.23	-10.5	10	3
1.59	0.43	1.29	0.23	-10.5	10	3
1.67	0.34	1.35	0.22	-10.5	10	3
1.67	0.42	1.41	0.15	-10.5	10	3
1.87	0.54	1.46	0.25	-10.5	10	3
1.90	0.46	1.51	0.25	-10.5	10	3
1.99	0.60	1.56	0.27	-10.5	10	3
2.14	0.60	1.63	0.29	-10.5	10	3
2.22	0.60	1.66	0.33	-10.5	10	3
2.23	0.61	1.71	0.30	-10.5	10	3

#### Sample calculation

$$E \text{ (dB } \mu\text{V/m)} = U \text{ (dB } \mu\text{V)} + \text{AF (dB 1/m)} + \text{Corr. (dB)}$$

U = Receiver reading

AF = Antenna factor

Corr. = sum of single correction factors of used cables, switch unit, distance correction, amplifier (if applicable)

distance correction =  $-20 * \text{LOG} (d_{Limit} / d_{used})$

Linear interpolation will be used for frequencies in between the values in the table.

Tables show an extract of values.

### 7.4 ANTENNA R&S HF907 (1 GHZ – 18 GHZ)

Frequency MHz	AF R&S HF907 dB (1/m)	Corr. dB
1000	24.4	-19.4
2000	28.5	-17.4
3000	31.0	-16.1
4000	33.1	-14.7
5000	34.4	-13.7
6000	34.7	-12.7
7000	35.6	-11.0

cable loss 1 (relay + cable inside chamber) dB	cable loss 2 (outside chamber) dB	cable loss 3 (switch unit, atten- uator & pre-amp) dB	cable loss 4 (to receiver) dB
0.99	0.31	-21.51	0.79
1.44	0.44	-20.63	1.38
1.87	0.53	-19.85	1.33
2.41	0.67	-19.13	1.31
2.78	0.86	-18.71	1.40
2.74	0.90	-17.83	1.47
2.82	0.86	-16.19	1.46

Frequency MHz	AF R&S HF907 dB (1/m)	Corr. dB
3000	31.0	-23.4
4000	33.1	-23.3
5000	34.4	-21.7
6000	34.7	-21.2
7000	35.6	-19.8

cable loss 1 (relay inside chamber) dB	cable loss 2 (inside chamber) dB	cable loss 3 (outside chamber) dB	cable loss 4 (switch unit, atten- uator & pre-amp) dB	cable loss 5 (to receiver) dB	used for FCC 15.247
0.47	1.87	0.53	-27.58	1.33	
0.56	2.41	0.67	-28.23	1.31	
0.61	2.78	0.86	-27.35	1.40	
0.58	2.74	0.90	-26.89	1.47	
0.66	2.82	0.86	-25.58	1.46	

Frequency MHz	AF R&S HF907 dB (1/m)	Corr. dB
7000	35.6	-57.3
8000	36.3	-56.3
9000	37.1	-55.3
10000	37.5	-56.2
11000	37.5	-55.3
12000	37.6	-53.7
13000	38.2	-53.5
14000	39.9	-56.3
15000	40.9	-54.1
16000	41.3	-54.1
17000	42.8	-54.4
18000	44.2	-54.7

cable loss 1 (relay inside chamber) dB	cable loss 2 (High Pass) dB	cable loss 3 (pre- amp) dB	cable loss 4 (inside chamber) dB	cable loss 5 (outside chamber) dB	cable loss 6 (to receiver) dB
0.56	1.28	-62.72	2.66	0.94	1.46
0.69	0.71	-61.49	2.84	1.00	1.53
0.68	0.65	-60.80	3.06	1.09	1.60
0.70	0.54	-61.91	3.28	1.20	1.67
0.80	0.61	-61.40	3.43	1.27	1.70
0.84	0.42	-59.70	3.53	1.26	1.73
0.83	0.44	-59.81	3.75	1.32	1.83
0.91	0.53	-63.03	3.91	1.40	1.77
0.98	0.54	-61.05	4.02	1.44	1.83
1.23	0.49	-61.51	4.17	1.51	1.85
1.36	0.76	-62.36	4.34	1.53	2.00
1.70	0.53	-62.88	4.41	1.55	1.91

#### Sample calculation

$$E \text{ (dB } \mu\text{V/m)} = U \text{ (dB } \mu\text{V)} + \text{AF (dB 1/m)} + \text{Corr. (dB)}$$

U = Receiver reading

AF = Antenna factor

Corr. = sum of single correction factors of used cables, switch unit, distance correction, amplifier (if applicable)

Linear interpolation will be used for frequencies in between the values in the table.

Tables show an extract of values.

### 7.5 ANTENNA EMCO 3160-09 (18 GHZ – 26.5 GHZ)

Frequency MHz	AF EMCO 3160-09 dB (1/m)	Corr. dB
18000	40.2	-23.5
18500	40.2	-23.2
19000	40.2	-22.0
19500	40.3	-21.3
20000	40.3	-20.3
20500	40.3	-19.9
21000	40.3	-19.1
21500	40.3	-19.1
22000	40.3	-18.7
22500	40.4	-19.0
23000	40.4	-19.5
23500	40.4	-19.3
24000	40.4	-19.8
24500	40.4	-19.5
25000	40.4	-19.3
25500	40.5	-20.4
26000	40.5	-21.3
26500	40.5	-21.1

cable loss 1 (inside chamber) dB	cable loss 2 (pre- amp) dB	cable loss 3 (inside chamber) dB	cable loss 4 (switch unit) dB	cable loss 5 (to receiver) dB
0.72	-35.85	6.20	2.81	2.65
0.69	-35.71	6.46	2.76	2.59
0.76	-35.44	6.69	3.15	2.79
0.74	-35.07	7.04	3.11	2.91
0.72	-34.49	7.30	3.07	3.05
0.78	-34.46	7.48	3.12	3.15
0.87	-34.07	7.61	3.20	3.33
0.90	-33.96	7.47	3.28	3.19
0.89	-33.57	7.34	3.35	3.28
0.87	-33.66	7.06	3.75	2.94
0.88	-33.75	6.92	3.77	2.70
0.90	-33.35	6.99	3.52	2.66
0.88	-33.99	6.88	3.88	2.58
0.91	-33.89	7.01	3.93	2.51
0.88	-33.00	6.72	3.96	2.14
0.89	-34.07	6.90	3.66	2.22
0.86	-35.11	7.02	3.69	2.28
0.90	-35.20	7.15	3.91	2.36

#### Sample calculation

$$E \text{ (dB } \mu\text{V/m)} = U \text{ (dB } \mu\text{V)} + AF \text{ (dB 1/m)} + Corr. \text{ (dB)}$$

U = Receiver reading

AF = Antenna factor

Corr. = sum of single correction factors of used cables, switch unit, distance correction, amplifier (if applicable)

Linear interpolation will be used for frequencies in between the values in the table.

Table shows an extract of values.

## 7.6 ANTENNA EMCO 3160-10 (26.5 GHZ – 40 GHZ)

Frequency GHz	AF EMCO 3160-10 dB (1/m)	Corr. dB	cable loss 1 (inside chamber) dB	cable loss 2 (outside chamber) dB	cable loss 3 (switch unit) dB	cable loss 4 (to receiver) dB	distance corr. (-20 dB/ decade) dB	d <sub>Limit</sub> (meas. distance (limit) m	d <sub>used</sub> (meas. distance (used) m
26.5	43.4	-11.2	4.4				-9.5	3	1.0
27.0	43.4	-11.2	4.4				-9.5	3	1.0
28.0	43.4	-11.1	4.5				-9.5	3	1.0
29.0	43.5	-11.0	4.6				-9.5	3	1.0
30.0	43.5	-10.9	4.7				-9.5	3	1.0
31.0	43.5	-10.8	4.7				-9.5	3	1.0
32.0	43.5	-10.7	4.8				-9.5	3	1.0
33.0	43.6	-10.7	4.9				-9.5	3	1.0
34.0	43.6	-10.6	5.0				-9.5	3	1.0
35.0	43.6	-10.5	5.1				-9.5	3	1.0
36.0	43.6	-10.4	5.1				-9.5	3	1.0
37.0	43.7	-10.3	5.2				-9.5	3	1.0
38.0	43.7	-10.2	5.3				-9.5	3	1.0
39.0	43.7	-10.2	5.4				-9.5	3	1.0
40.0	43.8	-10.1	5.5				-9.5	3	1.0

### Sample calculation

$$E \text{ (dB } \mu\text{V/m)} = U \text{ (dB } \mu\text{V)} + \text{AF (dB 1/m)} + \text{Corr. (dB)}$$

U = Receiver reading

AF = Antenna factor

Corr. = sum of single correction factors of used cables, switch unit, distance correction, amplifier (if applicable)

Linear interpolation will be used for frequencies in between the values in the table.

$$\text{distance correction} = -20 * \text{LOG} (d_{\text{Limit}} / d_{\text{used}})$$

Linear interpolation will be used for frequencies in between the values in the table.

Table shows an extract of values.

## 8 MEASUREMENT UNCERTAINTIES

Test Case	Parameter	Uncertainty
Conducted Emissions at AC mains	Voltage	± 3.4 dB
Radiated Emissions	Field Strength	± 5.5 dB

The measurement uncertainties for all parameters are calculated with an expansion factor (coverage factor)  $k = 1.96$ . This means, that the true value is in the corresponding interval with a probability of 95 %.

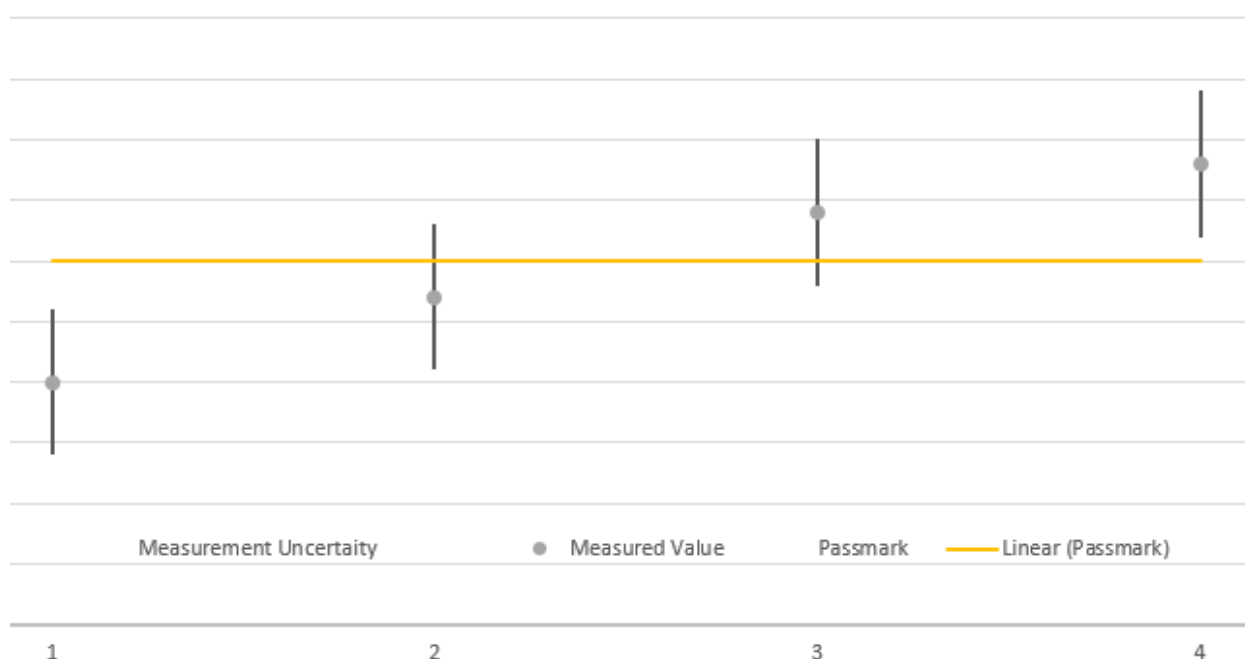

The verdicts in this test report are given according the above diagram:

Case	Measured Value	Uncertainty Range	Verdict
1	below pass mark	below pass mark	Passed
2	below pass mark	within pass mark	Passed
3	above pass mark	within pass mark	Failed
4	above pass mark	above pass mark	Failed

That means, the laboratory applies, as decision rule (see ISO/IEC 17025:2017), the so called shared risk principle.

## 9 PHOTO REPORT

Please see separate photo report.