

Hardware Manual

LTE Industrial Connectivity Gateway **ICR-1645**



© 2026 Advantech Czech s.r.o. No part of this publication may be reproduced or transmitted in any form or by any means, electronic or mechanical, including photography, recording, or any information storage and retrieval system, without prior written consent. Information in this manual is subject to change without notice and does not represent a commitment by Advantech.

Advantech Czech s.r.o. shall not be liable for any incidental or consequential damages arising from the use, performance, or furnishing of this manual.

All brand names used in this manual are registered trademarks of their respective owners. The use of trademarks or other designations in this publication is for reference purposes only and does not imply endorsement by the trademark holder.

Used symbols

Important



Important — Indicates a risk to personal safety or potential damage to the router. Follow these instructions precisely to prevent injury or equipment damage.

Warning



Warning — Highlights conditions that may cause malfunction, loss of data, or unexpected behavior in specific situations. Read carefully before proceeding.

Info



Info — Provides helpful tips, context, or references that improve understanding but are not strictly required to complete the task.

Contents

1. Product Overview	1
1.1 Document Contents	1
1.2 Product Introduction	2
1.3 Hardware Overview	3
1.4 Order Codes	5
1.5 Package Contents	6
1.6 Product Dimensions	7
1.7 Mounting Recommendations	10
1.8 Wall Mounting	11
1.9 DIN Rail Mounting	12
1.10 Product Label	13
1.11 First Use	14
2. Hardware Functionality	15
2.1 SIM Card Slots	15
2.2 Antennas Interfaces	16
2.3 Ethernet Interfaces	16
2.4 Power Supply	17
2.5 DIN & DOUT Interfaces	18
2.6 Serial Interfaces	19
2.7 LED Status Indication	20
2.8 Reset Functions	21
3. Technical Parameters	22
3.1 Basic Technical Parameters	22
3.2 Standards and Regulations	23
3.3 Type Testing and Environmental Conditions	24
3.4 Parameters of Cellular Module for ICR-16xx-EU	25
3.5 Parameters of Cellular Module for ICR-16xx-CN	26
3.6 Parameters of GNSS (for ICR-16xxG only)	27
3.7 Parameters of Wi-Fi (for ICR-16xxW only)	28
3.8 Parameters of I/O Ports	29
3.9 Parameters of Serial Interfaces	29
3.10 System Configuration	29
Appendix A: Troubleshooting	30
Appendix B: Customer Support	32
Appendix C: Regulatory & Safety Information	33
Appendix D: Related Documents	35

List of Figures

1	Router hardware overview – front view	3
2	Router hardware overview – rear view	4
3	Router dimensions – front, top and side view for basic set	7
4	Router dimensions – front, top and side view with wall-mounting holder	8
5	Router dimensions – front, top and side view with DIN holder	9
6	Wall Mounting Clip	11
7	Default position of the DIN rail clip	12
8	Product label	13
9	SIM card insertion	15
10	Ethernet connector pinout (RJ45 socket)	16
11	Power connector pinout	17
12	Grounding screw position	17
13	I/O connector pinout	18
14	Functional block diagram of the digital interface	18
15	Serial connector pinout	19
16	Resetting the router	21

List of Tables

1	Router hardware overview – front view	3
2	Router hardware overview – rear view	4
3	Order code overview	5
4	Package contents	6
5	Ethernet connector pinout (RJ45 socket)	16
6	Power connector pinout	17
7	I/O Ports Pinout	18
8	RS232 connection	19
9	RS485 connection	19
10	LED status indication	20
11	LED status indication	20
12	Basic parameters	22
13	Standards and regulations	23
14	Type testing and environmental conditions	24
15	Technical parameters of the cellular module	25
16	Technical parameters of the cellular module	26
17	Technical parameters of GNSS	27
18	Technical parameters of Wi-Fi	28
19	Electrical characteristics of digital input	29
20	Parameters of serial interfaces	29
21	System configuration	29

1. Product Overview

1.1 Document Contents

This manual provides comprehensive hardware information for Advantech ICR-1645 routers, covering the following key areas:

- **Product Overview** – Includes essential product details such as ordering codes, product revision history, package contents, physical dimensions, and mounting instructions.
- **Hardware Functionality** – Offers a detailed description of all hardware components, including SIM card slots, antenna connectors, Ethernet ports, power supply options, LED status indicators, reset button functionalities, and other physical interfaces.
- **First Use** – Provides step-by-step instructions for the initial setup and basic operation of the router.
- **Technical Specifications** – Lists key technical parameters, applicable standards and regulatory compliance information, results of type tests, cellular module specifications, and detailed interface parameters.

1.2 Product Introduction

The ICR-1645 series industrial connectivity gateway is designed for wireless communication, connecting IP devices and serial buses to cellular networks. It is ideal for M2M and IoT applications such as kiosks, industrial PCs, HMIs, traffic controllers, meters, UPS systems, and more. The **LTE** Cat.4 peak **downlink** data rate is around **150 Mbps**, with an **uplink** peak data rate of **50 Mbps**.

The ICR-1645 router features five Fast Ethernet ports (1x WAN + 4x LAN) and optional digital I/O (1x DI, 1x DO) and Serial (**1x RS232** + **1x RS485**) connectivity. Optional Wi-Fi 5 or GNSS can be included. The gateway supports **VPN** tunnel creation with various protocols for secure communications and provides diagnostic functions, including automatic monitoring and restart of connections, and a hardware watchdog to monitor router status.

Based on the ICR-OS operating system, the gateway's open Linux platform allows for extensive programming of customer software applications in **Python, C/C++**. It supports uploading of certain [Router Apps](#) to extend firmware functionalities, with a free app library available for customers to enhance specific router functionalities.

Compatibility with Advantech's **remote device management** platform, [WebAccess/DMP](#), offers extensive device management and monitoring, ensuring that devices remain up-to-date and secure.

1.3 Hardware Overview

In this chapter, all components of the router case are described, including links to chapters that provide more details.



Figure 1: Router hardware overview – front view

#	Item	Type	Description
1	RST	—	Button to reboot the router or restore default settings; see Chapter 2.8.
2	LEDs	—	Status LED indicators; see Chapter 2.7.
3	GND Screw	M3	Ensure proper grounding; refer to Chapter 2.4.
4	PWR	2-pin terminal	Power supply socket; see Chapter 2.4.
5	Serial & I/O	10-p term.	1 RS232, 1 RS485, 1 digital input, and 1 digital output interfaces. See Chapter 2.6 for serial interface details, Chapter 3.8 for I/O parameters, and Chapter 3.9 for serial interface parameters.
6	ETH0, ETH1	RJ45	1 Gb Ethernet LAN interfaces; see Chapter 2.3.
7	DIN Clip	—	DIN mounting clip, not included as standard accessories, can be ordered optionally; see Chapter 1.9.

Table 1: Router hardware overview – front view

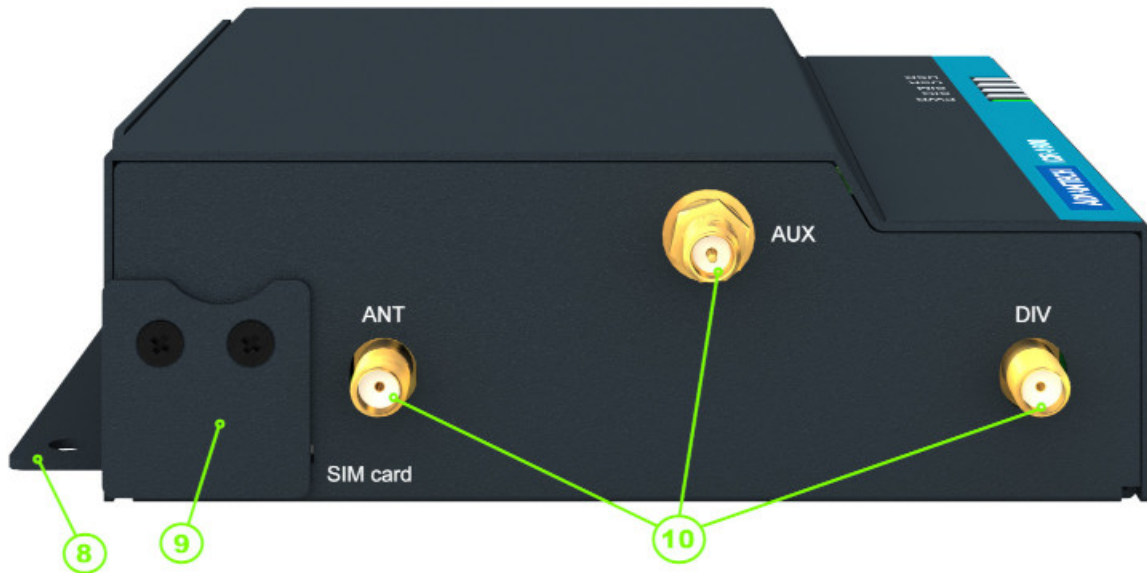

Figure 2: Router hardware overview – rear view

#	Item	Type	Description
8	Wall Clip	—	Wall mounting clip, included as standard accessories; see Chapter 1.8.
9	SIM Slots	Micro SIM	Two Micro SIM card slots; details in Chapter 2.1.
10	ANT, AUX and DIV	—	Connectors for both the main and diversity antennas of the cellular module. Refer to Chapter 2.2 for details, Chapter 3.4 & 3.5 for cellular module parameters.

Table 2: Router hardware overview – rear view

1.4 Order Codes

The table below provides an overview of the order codes.

Order Code	Configuration
ICR-1645-EU-A	LTE Connectivity Gateway with 5 x Gigabit Ethernet ports and 1xRS232+1xRS485+1xDI+1xDO ports for EMEA , certified with CE/UKCA.
ICR-1645W-EU-A	LTE Connectivity Gateway with 5 x Gigabit Ethernet ports and 1xRS232+1xRS485+1xDI+1xDO ports, Wi-Fi for EMEA , certified with CE/UKCA.
ICR-1645G-EU-A ¹	LTE Connectivity Gateway with 5 x Gigabit Ethernet ports and 1xRS232+1xRS485+1xDI+1xDO ports, GNSS for EMEA , certified with CE/UKCA.
ICR-1645-CN-A	LTE Connectivity Gateway with 5 x Gigabit Ethernet ports and 1xRS232+1xRS485+1xDI+1xDO ports for China .
ICR-1645W-CN-A	LTE Connectivity Gateway with 5 x Gigabit Ethernet ports and 1xRS232+1xRS485+1xDI+1xDO ports, Wi-Fi for China .
ICR-1645G-CN-A ¹	LTE Connectivity Gateway with 5 x Gigabit Ethernet ports and 1xRS232+1xRS485+1xDI+1xDO ports, GNSS for China .

Table 3: Order code overview

¹Availability may vary. Please consult your local sales representative for more information.

1.5 Package Contents

The standard set of the router includes the following items, as listed in the table below:







Item#	Description	Figure	Q'ty
11	Router		1 pc
12	Wall Mount Kit (packed in accessory box, including 4 screws of type M3 x 5L)		1 pc
13	2-pin terminal block for power supply (installed on the router)		1 pc
14	10-pin terminal block for Serial and IO (installed on the router)		1 pc
15	LTE Antennas (packed in accessory box)		2 pc
16	WiFi Antenna (packed in accessory box, WiFi model only)		1 pc
17	Printed <i>Quick Start Guide Leaflet</i>		1 pc

Table 4: Package contents

1.6 Product Dimensions

For the dimensions of the router see the figures below. Note that all sizes are measured in millimeters.

Basic Set

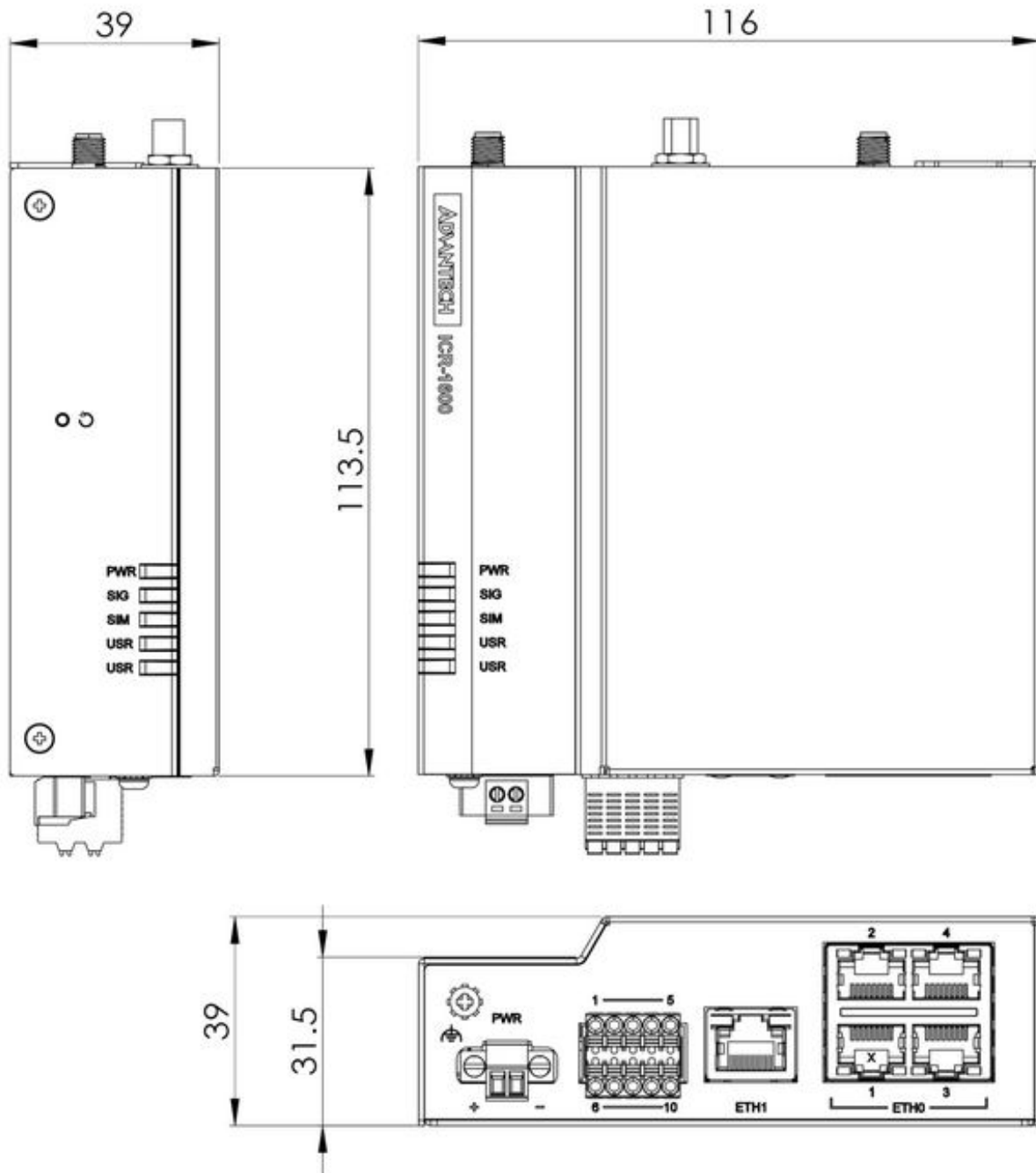

Figure 3: Router dimensions – front, top and side view for basic set

Wall Mount Clip Variant

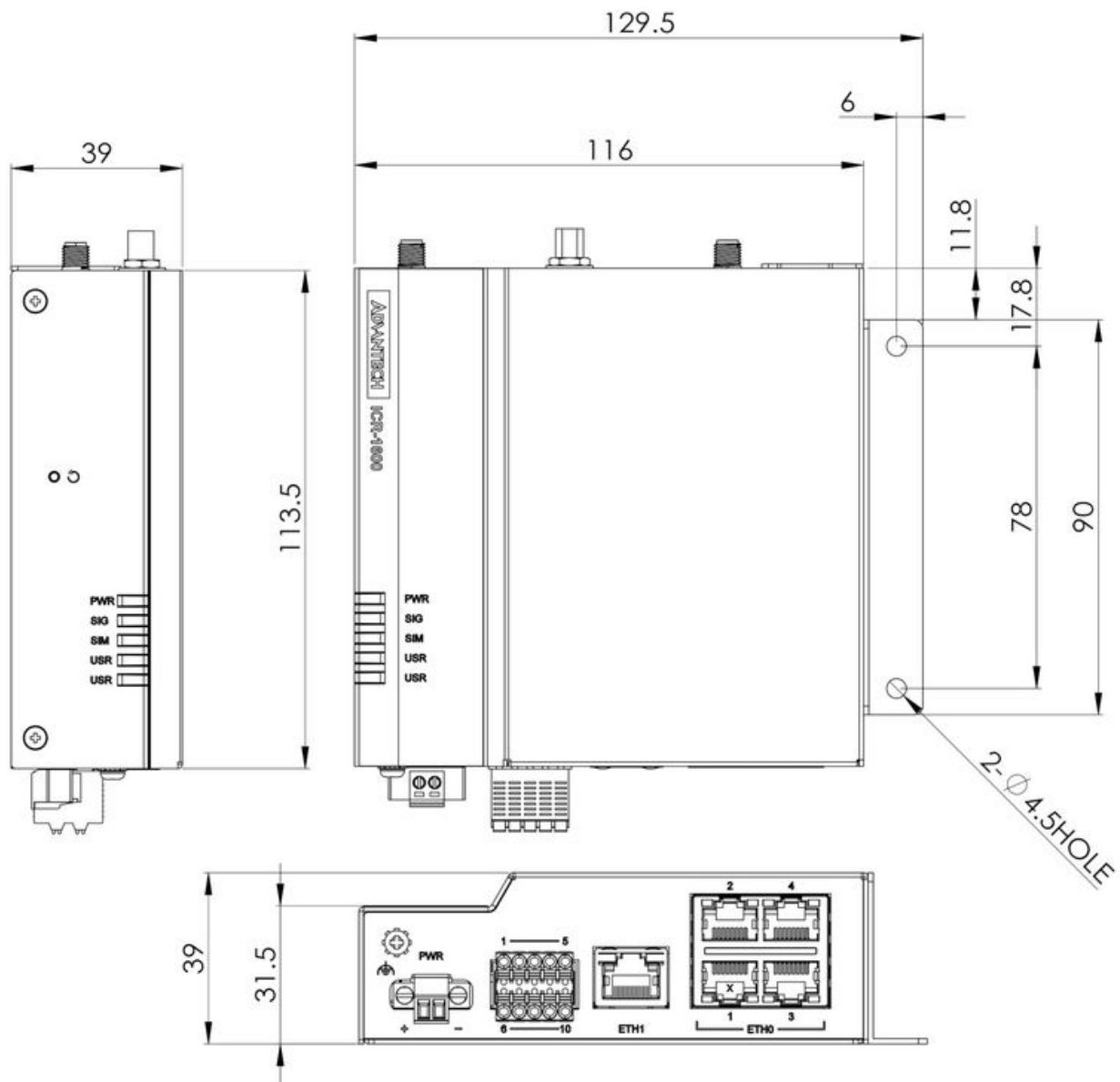

Figure 4: Router dimensions – front, top and side view with wall-mounting holder

DIN Rail Clip Variant (Optional)

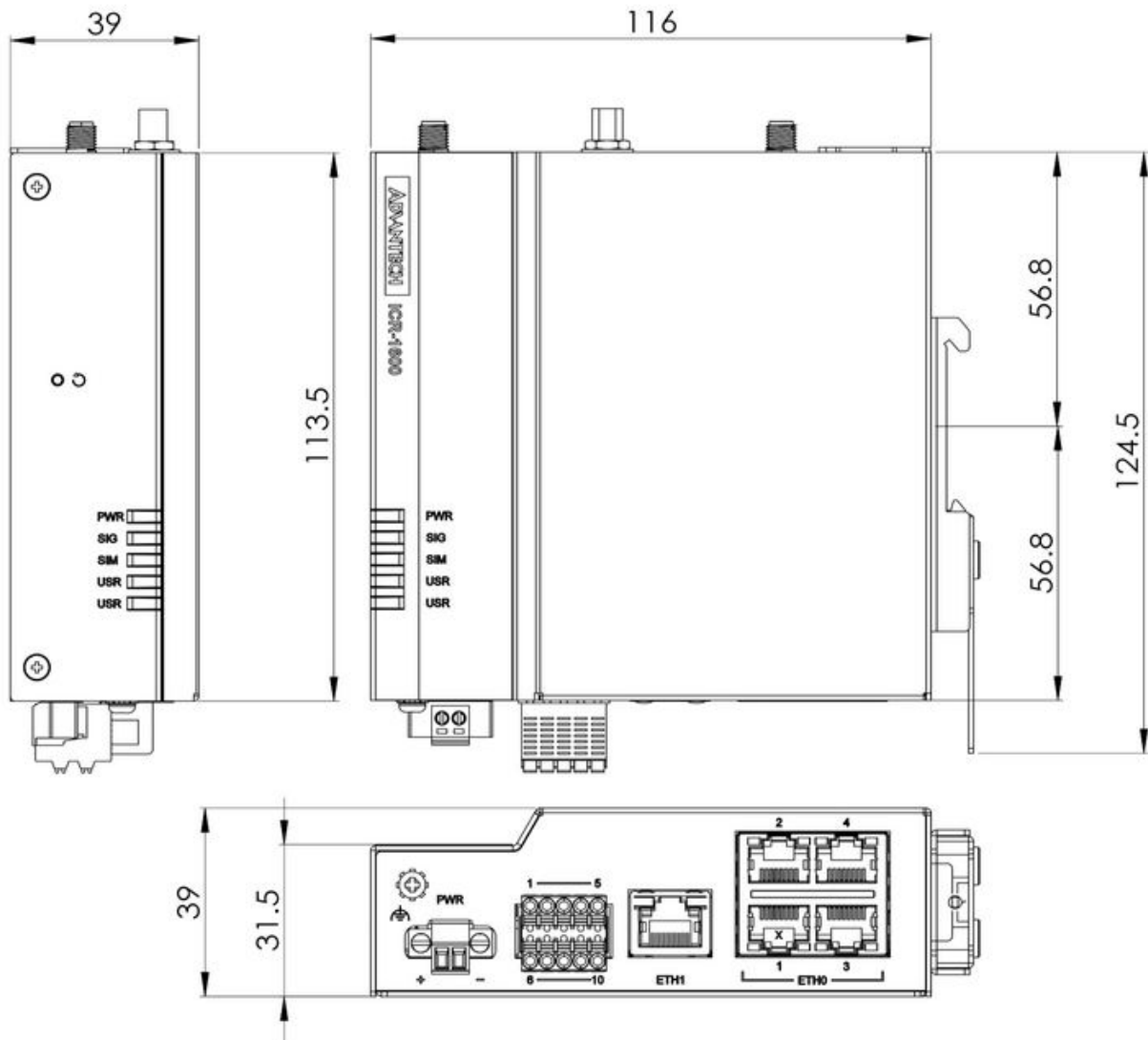

Figure 5: Router dimensions – front, top and side view with DIN holder

1.7 Mounting Recommendations

The router can be placed in the following ways:

- On a flat surface.
- On a wall using the wall-mounting clip (refer to Chapter 1.8).
- On a DIN rail EN 60715 with the metal DIN rail clip (refer to Chapter 1.9).

For most applications involving a built-in router within a switchboard, two types of environments are typically encountered:

- A non-public industrial environment with low voltage but high interference.
- A public environment with low voltage and without high interference.

For both of these environments, it's feasible to mount the router to a switchboard, eliminating the need for immunity examination or EMC-related issues as per EN 61439-1:2011 standards.

Warning

To comply with the EN 61439-1:2011 specification, follow these assembly instructions when attaching a router to a switchboard:

- When using whip antennas, maintain a minimum distance of 6 cm from cables and metal surfaces on all sides to avoid interference. If an external antenna is used apart from the switchboard, a lightning conductor is necessary.
- When mounting a router on sheet steel, consider using a cable antenna.

For all cables, it's recommended to bundle them, following these guidelines:

- The combined length of the cable bundle (power supply and data cables) should not exceed 1.5 m. If data cable length surpasses 1.5 m or if the cable runs toward the switchboard, installing surge protectors is advisable.
- Data cables must not be bundled with mains voltage cables (230 V/50 Hz or 120 V/60 Hz).
- Ensure sufficient space is left between each connector for cable handling.
- For proper router functionality, use an earth-bonding distribution frame to ground the grounding screw (refer to Chapter 2.4).

1.8 Wall Mounting

Info

The wall-mounting clip is included as a standard accessory (packed in the accessory box, including 4 screws of type M3 x 5L).

The router can be affixed to a wall or another surface using the wall-mounting clip. The delivered wall-mounting clip can be assembled to the router as shown in Figure 6.

The wall-mounting clip features two holes with a diameter of 4.5 millimeters for screw placement. For precise mounting dimensions, refer to Figure 4 in Chapter 1.6.

Warning

When attaching the wall-mounting clip, tighten the screws with a maximum torque of 0.6 Nm (6 kg.cm).



Figure 6: Wall Mounting Clip

1.9 DIN Rail Mounting

Info

The DIN rail mounting clip is not included as a standard accessory; it can be ordered separately under P/N OPT1-DIN-ICR1X-00.

You can attach the DIN rail clip to the router for mounting it onto a DIN rail that complies with the 60715 standards. The default position of the clip is depicted in Figure 7. If necessary, the clip can also be rotated into all four positions.

Warning

When attaching the clip, use 4 screws of type M3 x 5L, and tighten the screws with a maximum torque of 0.6 Nm (6 kg.cm).

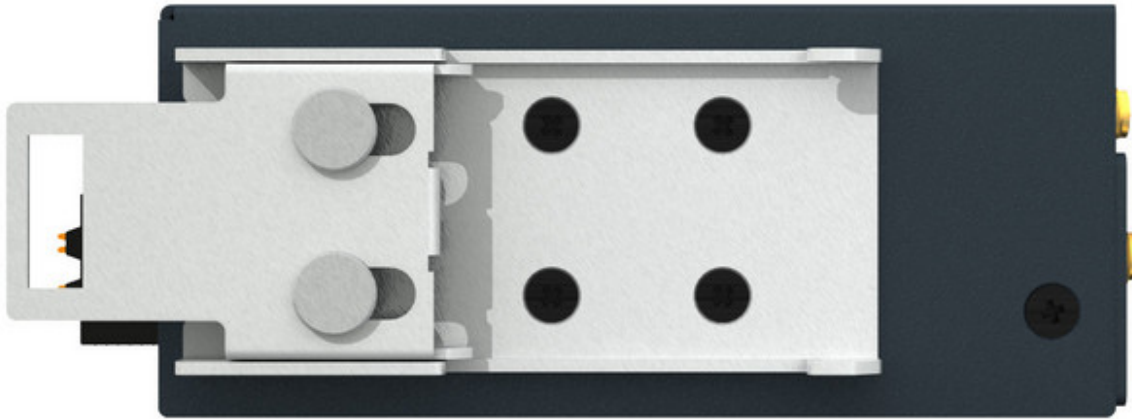

Figure 7: Default position of the DIN rail clip

1.10 Product Label

The figure below shows an example of the product labels with all the information printed on them.



Figure 8: Product label

1.11 First Use

You can perform the initial configuration of the router using a web browser on your PC. This interface enables router monitoring, configuration, and administration.

Warning

- Before putting the router into operation, ensure that all components required for running your applications are connected. Refer to Chapter [1.3 Hardware Overview](#) for an overview of the hardware.
- Do not operate the router without an antenna connected to the main antenna connector. Transmitted energy will be reflected by an open connector, which could potentially damage the equipment.
- This device utilizes radio frequency bands that may be subject to specific usage restrictions in certain European Union countries (e.g., indoor use only). Please refer to [Appendix C](#) for detailed regulatory information before operation.

The procedure for connecting to a new router is described in the *Configuration Manual [1]*, Chapter *Getting Started* → *Configuration Environments* → *Web Interface Initial Setup*. This manual also provides detailed descriptions and examples of router configuration using the web interface.

2. Hardware Functionality

See Chapter 1.3 for an overview of the product's hardware, along with links to chapters offering detailed explanations.

2.1 SIM Card Slots

Slots for two SIM cards are located on the router beneath a metal cover. If you plan to use this device for cellular network communication, insert an activated data-provisioned SIM card into the SIM card slot. You have the option to install two SIM cards simultaneously for utilizing the switching feature. The SIM cards can have different Access Point Names (APNs) configured. The procedure for changing SIM cards is outlined below. If the SIM requires a PIN, input it in the router's web interface (*Administration* → *Unlock SIM Card*).

Info

Type of SIM card: Micro SIM (3FF) 15.0 × 12.0 × 0.76 mm.

Warning

Inserting the SIM card:

- Always disconnect the router from the power supply before handling the SIM card.
- Unscrew the two screws on the SIM card cover and remove the cover.
- To remove an inserted SIM card, use the flat end of a spudger or your fingernail to press the SIM card slightly into its slot until you hear a click. Upon hearing the click, release the card, and it will pop out of its slot.
- To insert a SIM card, push the card into the slot until it clicks into place.
- Put the cover back and secure it with the two screws.



Figure 9: SIM card insertion

2.2 Antennas Interfaces

The ANT and DIV SMA female connectors are intended for connecting the main and diversity cellular antennas to the router. Additionally, SMA/RP-SMA¹ female connectors labeled *AUX* are provided for connecting GNSS/Wi-Fi antennas on models that support Wi-Fi or GNSS.

Warning



Do not run the router without connected cellular antennas as the energy from the transmission is effectively reflected by the open end and can damage the equipment.

Info



Recommended tightening moment for screwing the antenna to the SMA connector is 0.9 Nm.

2.3 Ethernet Interfaces

The RJ45 panel socket is used for four ETH0 and one ETH1 Ethernet interfaces. The pinout of the socket is shown in Figure 10 and described in Table 5.

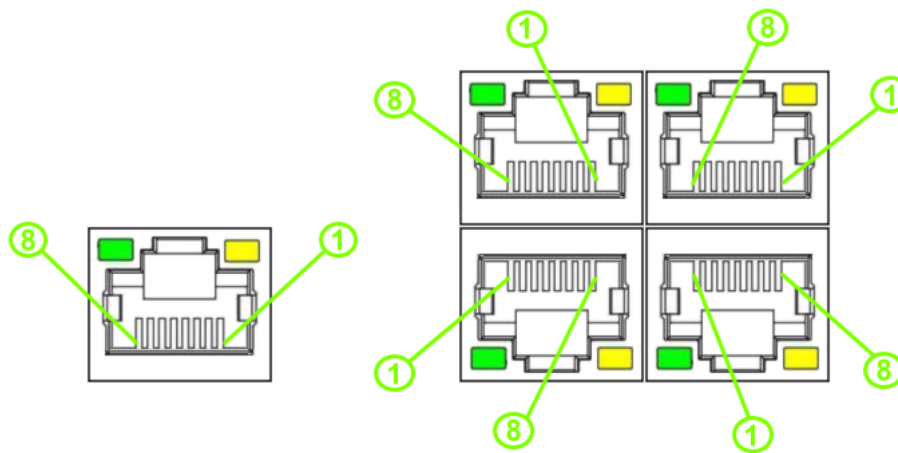

Figure 10: Ethernet connector pinout (RJ45 socket)

Pin	10base-T & 100base-T	1000base-T
1	Tx+ (Transmit Data+)	BI_DA+ (BiDirectional pair A+)
2	Tx- (Transmit Data-)	BI_DA- (BiDirectional pair A-)
3	Rx+ (Receive Data+)	BI_DB+ (BiDirectional pair B+)
4	—	BI_DC+ (BiDirectional pair C+)
5	—	BI_DC- (BiDirectional pair C-)
6	Rx- (Receive Data-)	BI_DB- (BiDirectional pair B-)
7	—	BI_DD+ (BiDirectional pair D+)
8	—	BI_DD- (BiDirectional pair D-)

Table 5: Ethernet connector pinout (RJ45 socket)

Info



The isolation barrier of the Ethernet ports against the ground is 1500 V.

¹SMA female for GNSS, RP-SMA female for Wi-Fi

2.4 Power Supply

A two-pin terminal connector (pitch 3.5 mm) is utilized to power the router. The corresponding connector is included as a standard accessory with the router.

Pin	Signal mark	Description
1	VCC(+)	Positive pole of DC supply voltage (+9 to +48 V DC)
2	GND(-)	Negative pole of DC supply voltage

Table 6: Power connector pinout

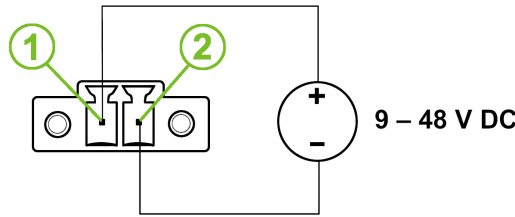

Figure 11: Power connector pinout

The required power supply voltage for the router ranges between +9 V and +48 V DC. Refer to the connection scheme in Figure 11 for proper setup. The router is equipped with built-in protection against reversed polarity, functioning without signaling. To guarantee correct operation, the power source must be capable of providing a sufficient amount of energy, as detailed in the consumption section of Chapter 3.1.

Warning



Grounding the router using the grounding screw eliminates the protection against reversed polarity. Ensure the negative pole of the DC power supply shares the same voltage reference as the grounding screw. A voltage difference between these points may damage the router, necessitating repairs exclusively by an authorized service center.

Warning



Unit has to be supplied by a power supply specified as a Limited Power Source (LPS) or CEC/NEC Class 2 source of supply.

Info



The power supply (common pole) is not connected to the metal case of the router nor to the internal ground, see Figure 14.

If recommended for the installation environment, protect the router by properly grounding it using the grounding screw, as depicted in Figure 12. The maximum tightening torque for the grounding screw is 0.6 Nm (6 kg.cm).



Figure 12: Grounding screw position

2.5 DIN & DOUT Interfaces

The pins of I/O interface are physically connected to the 10-pin terminal block panel socket. The pinout of the I/O interface is described in Figure 13 and Table 7.

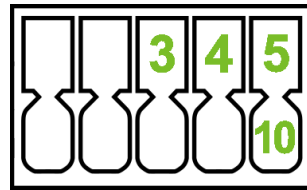

Figure 13: I/O connector pinout

Pin	Signal mark	Description
3	BIN	Digital input
4	BOUT	Digital output
5,10	GND	Ground (common negative pole)

Table 7: I/O Ports Pinout

Info

The I/O interface is not electrically isolated from the router.

The I/O user interface is designed for digital input processing and digital output control. For detailed electrical parameters see Chapter 3.8. The functional scheme of connection for the digital input and digital output is in Figure 14.

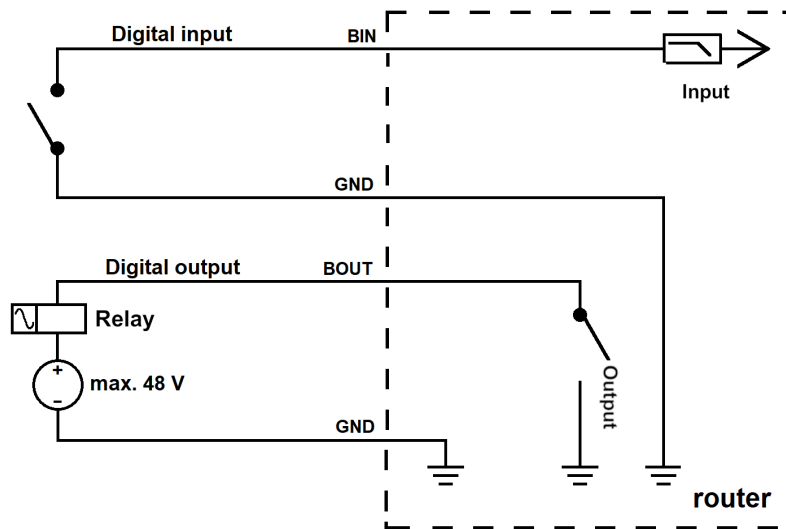

Figure 14: Functional block diagram of the digital interface

2.6 Serial Interfaces

Two independent serial interfaces are connected to the 10-pin terminal block panel socket.

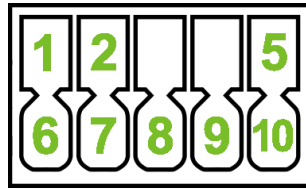

Figure 15: Serial connector pinout

The RS232 interface can be configured on the web GUI by navigating to *Configuration* → *Expansion Port 1*. For the pinout, refer to Table 8. .

Pin	Signal mark	Description
6	TXD	OUT
7	RXD	IN
8	RTS	OUT
9	CTS	IN
10	GND	GROUND

Table 8: RS232 connection

The RS485 interface can be configured on the web GUI by navigating to *Configuration* → *Expansion Port 2*. For the pinout, refer to Table 9.

Pin	Signal mark	Description
1	D (+)	IN/OUT
2	D (-)	IN/OUT
5	GND	GROUND

Table 9: RS485 connection

Info

The serial interfaces are not electrically isolated from the router.

2.7 LED Status Indication

There are status LEDs on the top side of the router to provide router status information. Moreover, ETH0 and ETH1 connectors, located on the front panel, have two additional LEDs providing information about the port status.







	Caption	Color	State	Description
	PWR	Green Green Off	On Blinking Off	Powered up, the system is booting up. System is ready and operating normally. No power.
	SIG	Green Orange Red Off	On / blinking On / blinking On / blinking Off	Good cellular signal. Fair cellular signal. Poor cellular signal. No cellular link.
	SIM	Green Orange Green Orange Red Off	Blinking Blinking On On Fast blinking Off	SIM 1 is selected, waits for data connection. SIM 2 is selected, waits for data connection. Connects through SIM 1. Connects through SIM 2. Missing SIM card or PIN code problem. No SIM card is selected.
	USR	Green	—	The function of these LEDs are user-defined.
	ETH0 ETH1	Green Green	On Off	Selected 1 Gbps bit rate. Selected 100/10 Mbps bit rate.
	ETH0 ETH1	Yellow Yellow Yellow	On Brief blinks Off	off The network cable is connected. Data transmission. The network cable is not connected.

Table 10: LED status indication

The following describes when *USR* is defined as Serial or Wi-Fi:



	Caption	Color	State	Description
	Serial/USR	Green Off	Blinking Off	Serial Port 1 TX/RX transmitting data. No RS232/RS485 data.
	Wi-Fi/USR	Green Green Off	On Blinking Off	AP or STA mode is selected. Transmitting data. No AP or STA mode is selected.

Table 11: LED status indication

2.8 Reset Functions

The *RST* button has multiple functions. For more details, refer to the configuration manual [1], Chapter *Introduction* → *Device* → *Reset*.

Info

Use a narrow screwdriver or a small tool to press the *RST* button.



Figure 16: Resetting the router

3. Technical Parameters

3.1 Basic Technical Parameters

Parameter	Description
Temperature range	Operating: -30 °C to +75 °C (-22 °F to +167 °F) Storage: -40 °C to +85 °C (-40 °F to +185 °F)
Humidity	Operating: 5 to 95 % relative humidity non condensing Storage: 5 to 95 % relative humidity non condensing
Altitude	Operating: 2000 m / 70 kPa
Degree of protection	IP30
Supply voltage	9 – 48 V DC
Consumption for non-Wi-Fi / Wi-Fi version	Idle: 2.7 W / 3.6 W Average: 3.7 W / 4.8 W Maximum: 5.5 W / 6.8 W
Dimensions of device (w/o clips)	116 × 39 × 113.5 mm (4.56" × 1.53" × 4.47")
DIN rail clip specification	DIN 30 mm (DIN clip is an optional)
Weight	ICR-16XX: 470 g (1.04 lbs) (excl. accessories below) LTE Antenna: 25.2 g (0.06 lbs) Wall-mount bracket: 50 g (0.11 lbs) Wi-Fi Antenna 7.8 g (0.02 lbs)

Table 12: Basic parameters

3.2 Standards and Regulations

Parameter	Description
Radio	EN 301 908-1, EN 301 908-2, EN 301 908-13, EN 301 908-25, EN 303 413, EN 300 328, EN 301 893
EMC	EN 301 491-1, EN 301 489-17, EN 301 489-19, EN 301 489-52, EN 61000-6-2, EN 61000-6-3, EN 55032, EN 61000-4-2, EN 61000-4-3, EN 61000-4-4, EN 61000-4-5, EN 61000-4-6
Safety	EN 62368-1
Mechanical	EN 60529, EN 60068-2-27, EN 60068-2-64
Climatic	EN 60068-2-1, EN 60068-2-2, EN 60068-2-14, EN 60068-2-78
National	ICR-16xx-EU: CE, UKCA
Environmental	REACH, RoHS3 and WEEE compliant

Table 13: Standards and regulations

3.3 Type Testing and Environmental Conditions

Phenomena	Test	Description	Test levels
ESD	EN 61000-4-2	Enclosure contact	± 8 kV (crit. B)
RF field AM modulated	EN 61000-4-3	Enclosure	3 V/m (crit. A) (80 – 1000 MHz)
Fast transient	EN 61000-4-4	Signal ports Power ports Ethernet ports	± 0.5 kV (crit. A)
Surge	EN 61000-4-5	Ethernet ports Power ports	± 0.5 kV (crit. B), ± 1 kV (crit. B) open circuit
RF conducted	EN 61000-4-6	All ports	3 V/m (crit. A) (0.15 – 80 MHz)
Radiated emission	EN 55032	Enclosure	Class B
Conducted emission	EN 55032	Signal ports Power ports Ethernet ports	Class B Class B Class B
Dry heat	EN 60068-2-2	Test Bb, storage +85 °C, operation +75 °C	
Cold	EN 60068-2-1	Test Ab, storage -40 °C, operation -40 °C	
Damp heat	EN 60068-2-78	95 % rel. humidity (+40 °C)	
Dry heat, cyclic	EN 60068-2-30	+55 °C / +25 °C, rel. humidity 95 %, 12 h - 12 h	
Dry heat	EN 60068-2-2	Test Bb, storage +85 °C, operation +75 °C	
Thermal shock / temp. variation	EN 60068-2-14	Test Nb, -30 °C/+75 °C, 3h/3h, 2 cycles, 3 K/min	
Degrees of protection provided by enclosures	EN 60529	IP30	
Vibration, broadband random	EN 60068-2-64	Spectrum A.3 cat 1, breakpoints A.6 cat 1	
Shock	EN 60068-2-27	50 m/s ² , 11 ms, half sine, 10 in each dir.	

Table 14: Type testing and environmental conditions

3.4 Parameters of Cellular Module for ICR-16xx-EU

Parameter	Description
Antenna	<ul style="list-style-type: none"> • Connector type: SMA • Impedance: 50 Ω
LTE parameters	<ul style="list-style-type: none"> • LTE Cat.4, 3GPP Rel.11 • FDD bands: B1 (2100 MHz), B3 (1800 MHz), B7 (2600 MHz), B8 (900 MHz), B20 (800 MHz), B28A (700MHz) • TDD bands: B38 (2600 MHz), B40 (2300 MHz), B41 (2500 MHz) • Bit rates: up to 150 Mbps (DL), 50 Mbps (UL)
HSPA+/UMTS parameters	<ul style="list-style-type: none"> • Supported frequencies: B8 (900 MHz), B1 (2100 MHz) • Bit rates: up to 42 Mbps (DL) / 5.76 Mbps (UL)
EDGE/GPRS parameters	<ul style="list-style-type: none"> • Supported frequencies: B8 (900 MHz), B3 (1800 MHz) • Bit rates: up to 296 kbps (DL) / 236.8 kbps (UL)

Table 15: Technical parameters of the cellular module

3.5 Parameters of Cellular Module for ICR-16xx-CN

Parameter	Description
Antenna	<ul style="list-style-type: none"> • Connector type: SMA • Impedance: 50 Ω
LTE parameters	<ul style="list-style-type: none"> • LTE Cat.4, 3GPP Rel.11 • FDD bands: B1 (2100 MHz), B3 (1800 MHz), B5 (850 MHz), B8 (900 MHz) • TDD bands: LTE-TDD Bands: B34 (2000MHz), B38 (2600 MHz), B39 (1900MHz), B40 (2300 MHz), B41 (2500 MHz) • LTE-FDD transfer rate: 150 Mbps (DL), 50 Mbps (UL) • LTE-TDD transfer rate: 130 Mbps (DL), 30 Mbps (UL)
HSPA+/UMTS parameters	<ul style="list-style-type: none"> • WCDMA Bands: B1/B8 • WCDMA transfer rate: 384 kbps (DL/UL) • TD-SCDMA Bands: B34/B39 • TD-SCDMA transfer rate: 2.4 Mbps (DL), 2.2 Mbps (UL)
EVDO/CDMA Parameters	<ul style="list-style-type: none"> • CDMA800 • Transfer rate EVDO: 3.1 Mbps (DL), 1.8 Mbps (UL)
EDGE/GPRS parameters	<ul style="list-style-type: none"> • Supported frequencies: EGSM900/ DCS1800 • GPRS transfer rate: 107 kbps (DL), 85.6 kbps (UL) • EDGE transfer rate: 296 kbps (DL), 236.8 kbps (UL)

Table 16: Technical parameters of the cellular module

3.6 Parameters of GNSS (for ICR-16xxG only)

Parameter	Description
GNSS Systems	GPS, Galileo, QZSS, GLONASS, and BDS
Antenna	Connector type: SMA Input impedance: 50 Ω Supports active or passive antenna
Features	Protocol: NEMA 0183
Frequency	GPS: 1575.42 \pm 1.023 MHz Galileo: 1575.42 \pm 2.046 MHz QZSS: 1575.42 MHz GLONASS: 1597.5–1605.8 MHz BDS: 1561.098 \pm 2.046 MHz
Sensitivity (autonomous)	Acquisition: -146 dBm Reacquisition: -157 dBm Tracking: -157 dBm
Acquisition time (autonomous)	Cold start: 35.0 s Warm start: 26.0 s Hot start: 2.5 s
Accuracy	2.5 m

Table 17: Technical parameters of GNSS

3.7 Parameters of Wi-Fi (for ICR-16xxW only)

Parameter	Description
Antenna Connectors	R-SMA - 50 Ω
Supports Wi-Fi bands	2.400 – 2.4835 GHz 5.150 – 5.850 GHz
Standards	IEEE: 802.11b, 802.11b/g, 802.11b/g/n, 802.11a, 802.11an, 802.11ac
2.4 GHz supported channels	1, 2, 3, 4, 5, 6, 7, 8, 9, 10, 11, 12, 13
5 GHz supported channels	36, 40, 44, 48, 149, 153, 157, 161, 165
Type of Device	Access point (AP) Station (STA)
Security – Standards	WPA, WPA2, WPA3, 802.1X
Security – Encryption	WEP, TKIP, AES
AP maximum users	Access Point mode: up to 16 clients max

Table 18: Technical parameters of Wi-Fi

3.8 Parameters of I/O Ports

Electrical characteristics of the digital input are in Table 19. Status of the digital input can be retrieved in the router's web interface (on the *General Status* page) or by the `status ports` and `io get` commands, see *Command Line Interface* application note.

Logical ¹	Status ²
1	Open
0	Short to ISO_GND

Table 19: Electrical characteristics of digital input

The maximum digital output load is **500 mA** at **48 V**.

3.9 Parameters of Serial Interfaces

Supported parameters of the RS232 and RS485 interfaces, which can be configured on Web GUI in *Configuration* → *Expansion Port 1* resp. *Configuration* → *Expansion Port 2* menu items, are in Table 20.

Parameter	Description
Baudrate	300, 600, 1200, 2400, 4800, 9600, 19200, 38400, 57600, 115200.
Data Bits	5, 6, 7, 8.
Parity	none, even, odd.
Stop Bits	1, 2.
Flow Control	none, CTS/RTS

Table 20: Parameters of serial interfaces

3.10 System Configuration

The main parameters of the system are listed in Table 21.

Parameter	Description
CPU architecture	ARM Cortex-A7
CPU frequency	1.2 GHz
CPU power	1.9 DMIPS/MHz
Flash memory	512 MB of NAND <ul style="list-style-type: none"> • ≈ 65 MB for Router Apps • ≈ 26 MB for customer data
RAM size	total: 256 MB; available: ≈ 160 MB
Watchdog	Yes

Table 21: System configuration

¹The digital status returned by the `io get` shell command.

²The digital status returned by the `status ports` shell command and displayed on the *General Status* page.

Appendix A: Troubleshooting

Warning

If you cannot connect to the router from your PC, your network card may be configured in a way that prevents a connection. Try one or more of the following steps to resolve the issue:

- Ensure your PC's network card is configured to obtain an IP address automatically from a DHCP server (the router's DHCP server is enabled by default).
- Connect the router to the PC via a network switch.
- Connect the PC directly to the router, but start the router first and wait for it to initialize completely before starting the PC.

Ethernet Connection Fails or Is Unstable

- On the router's *Configuration* → *LAN* page, you can disable auto-negotiation and manually set a specific link speed and duplex mode. This can resolve compatibility issues with some network devices.

Mobile WAN Connection Fails or Is Intermittent

- Check the signal strength on the *Status* → *Mobile WAN* page. If the signal is weak, a more powerful antenna is required. If neighboring cells have similar signal strength, a directional antenna may be necessary to lock onto the optimal cell tower.
- Enable the connection check feature on the *Configuration* → *Mobile WAN* page in the *Check connection* section. Select the *Enable + bind* option. This will send periodic pings to check connectivity and restart the connection if it fails. The "bind" option ensures the ping is always sent through the Mobile WAN interface.

Cannot Establish Mobile WAN Connection

- Verify all settings on the *Configuration* → *Mobile WAN* page, including the *APN*, *username*, *password*, and *IP address*. For many public networks, these fields can be left blank.
- Check if the SIM card requires a PIN. If so, enter it on the *Administration* → *Unlock SIM Card* page.
- For private APN networks, it is often not recommended to obtain DNS server addresses from the operator. Disable this option on the *Configuration* → *Mobile WAN* page.
- Check the *Status* → *System Log* for error messages that can help diagnose the issue.

Cannot Connect to a Device Behind the Router from the Internet (NAT)

- The device behind the router must be configured to use the router's IP address as its default gateway.

Cannot Access a Web Server Behind the Router via NAT

- Remote HTTP access to the router itself must be disabled. This can be done on the *Configuration* → *NAT* page.
- On the same page, enable the *Send all remaining incoming packets to default server* feature and enter the IP address of your web server.
- Ensure the web server's default gateway is set to the router's IP address.

DynDNS Does Not Work

- DynDNS will not work with a private APN if the router's IP address is not publicly accessible.
- If your DynDNS hostname resolves to the same private IP address that is assigned to the router, it means your mobile operator is using NAT or a firewall, preventing direct connections.

- You can verify operator NAT by pinging a server with a static public IP and comparing the source IP (seen by the server) with the IP address shown on the router's status page.
- You can test for a firewall by trying to access the router's web interface remotely.
- The operator may not be providing DNS server addresses. Without DNS, the router cannot resolve the DynDNS service hostname. The System Log would show errors like:
 - Error resolving hostname: no such file or directory
 - Connect to DynDNS server failed

L2TP or IPsec Tunnel Fails to Establish

- Check the *Status* → *System Log* for specific error messages related to the VPN tunnel negotiation.

IPsec Tunnel Establishes, but No Data Is Transferred

- This is typically caused by incorrect routing rules or a misconfigured default gateway on either the client device or the remote network.

Router Reverts to Online Mode After a Reboot, Despite Being Set to Offline via SMS

- State changes made via SMS commands are temporary and do not alter the saved configuration. They remain in effect only until the router is rebooted.

Serial Communication Is Not Working

- Verify that your router model is equipped with a serial port. Check the serial communication settings on the *Configuration* → *Expansion Port* page.

Is the Router Cisco Compatible?

- No. The router's operating system (ICR-OS) is based on Linux, not Cisco IOS. Therefore, Cisco configuration commands cannot be used.
- However, since all network connections are based on open standards, the router is fully compatible and can be connected to Cisco devices or any other standard networking equipment.

FTP or SFTP Does Not Work

- **FTP** is available on v2 platform routers only. Ensure it is enabled in *Configuration* → *Services* → *FTP*. Connect using any FTP client to port **21** with the same username and password as the web interface.
- **SFTP** (SSH File Transfer Protocol) is available on all routers. Ensure SSH is enabled in *Configuration* → *Services* → *SSH*. Connect using any SFTP-capable client (like FileZilla or WinSCP) to port **22** with the same credentials as the web interface.

How to Access the Router's Command Line

- You can connect to the router's command line using SSH (all routers) or Telnet (v2 routers only).
- **SSH** is enabled by default. You can verify this in *Configuration* → *Services* → *SSH*. Use any SSH client to connect to the router's IP address on port **22**.
- **Telnet** can be enabled on v2 routers in *Configuration* → *Services* → *Telnet*.
- For both methods, use the same username and password as for the web interface.

Appendix B: Customer Support

Customer Support for Europe

Advantech Czech s.r.o.

Sokolska 71
562 04, Usti nad Orlici
Czech Republic

Phone: +353 91 792444
Fax: +353 91 792445
E-mail: iiotcustomerservice@advantech.eu
Web: www.advantech.com

Customer Support for NAM

Advantech North America

707 Dayton Road
Ottawa, IL 61350 USA

Phone: +1-800-346-3119 (Monday – Friday, 7 a.m. to 5:30 p.m. CST)
Fax: +1-815-433-5109
E-mail: support.iiot.ana@advantech.com
Web: www.advantech.com

Customer Support for Asia

Phone: +886-2-2792-7818 #1299 (Monday – Friday, 9 a.m. to 5:30 p.m. UTC+8)
Fax: +886-2-2794-7327
E-mail: icg.support@advantech.com.tw
Web: www.advantech.com

Appendix C: Regulatory & Safety Information

Safety Notices

For your safety and proper operation of the device, please observe the following instructions:

- The router must comply with all applicable international, national, and local regulations, including any specific restrictions concerning its use in designated applications and environments.
- To avoid personal injury or damage to the device, use only accessories that are approved or supplied by the manufacturer. Unauthorized modifications or the use of non-approved accessories may damage the router, violate regulations, and void the warranty.
- Do not attempt to open the router enclosure under any circumstances.
- Before handling the SIM card, always switch off the router and disconnect it from the power supply. Handle the SIM card with care to avoid damage or electrostatic discharge.

Important



This equipment is not suitable for use by or near young children. Small children could accidentally swallow the SIM card.

- Always ensure that the power supply voltage does not exceed 48 V DC.
- Do not expose the router to harsh environmental conditions. Protect it from dust, moisture, and excessive temperatures.
- Use only routers with proper certifications and markings in areas containing flammable or explosive materials (such as gas stations, chemical plants, or locations with explosives). In these environments, always follow the applicable restrictions regarding the use of radio devices.
- When traveling by airplane, always switch off the router. Using the router on board may endanger flight safety, interfere with mobile networks, and violate local regulations. Non-compliance can result in suspension or cancellation of telecommunications services or legal penalties.
- Take special care when operating the router in close proximity to personal medical devices such as cardiac pacemakers or hearing aids. If in doubt, consult the manufacturer of the medical device or your physician.
- This device may cause interference if used near television sets, radio receivers, or personal computers.
- Maintain a minimum separation distance of at least 20 cm between the router and the human body during operation.
- It is strongly recommended to regularly back up all critical configuration data stored in the router's memory.
- **Specific Usage Restrictions for 5 GHz Wi-Fi:** This device operates in the 5150–5350 MHz frequency band, which is restricted to **indoor use only** within the European Union, EFTA countries, and Northern Ireland. Outdoor use in this frequency band is prohibited to prevent harmful interference with other radio services.

	AT	BE	BG	CY	CZ	DE	DK	EE	EL	ES	FI
	FR	HR	HU	IE	IT	LT	LU	LV	MT	NL	PL
	PT	RO	SE	SI	SK	IS	LI	NO	CH	TR	UK

Product Disposal Instructions

The WEEE directive (Waste Electrical and Electronic Equipment: 2012/19/EU) ensures the environmentally responsible recycling and recovery of electronic products. This device contains high-quality materials and components suitable for recycling. At the end of its life, **do not dispose of this product with ordinary commercial waste**. The router also contains a battery. Remove the battery before disposing of the device, and ensure the battery is disposed of separately and in accordance with local regulations. For detailed information on product and battery disposal, consult your supplier's terms and conditions.

Appendix D: Related Documents

[1] [ICR-1600 Configuration Manual](#)

[EP] Product-related documents and applications can be obtained on **Engineering Portal** at <https://icr.advantech.com/support/router-models> address.



We, Advantech Czech s.r.o., declare that the radio equipment narrated in this user's manual complies with Directive **2014/53/EU**.



We, Advantech Czech s.r.o., declare that the radio equipment narrated in this user's manual complies with Radio Equipment Regulations 2017 (**S.I. 2017 No. 1206**).

The full text of the EU Declaration of Conformity is available at the following internet address:
icr.advantech.com/doc