

OPT1-ANT-4GS-21

CELLULAR / LTE
Screw Mount Antenna

Key Features

Cable 1: CELLULAR / LTE

- 698-960 MHz

- 1710-2170 MHz

- 2500-2700 MHz

Screw Mount

Anti-Rotation Mechanism

Ground Plane Independent

Customizable Cable and Connector

Dimensions: Ø 50 x 50.8 mm

Certificates: IP67, IP69



1. Antenna and electrical specifications

Cable 1

Parameters	CELLULAR / LTE Antenna		
Standards	2G,3G and 4G		
Band (MHz)	700/850/900	1700/1800/1900/2100	2600
Frequency (MHz)	698-960	1710-2170	2500-2700
Return Loss (dB)	~-10.1	~-11.5	~-7.5
VSWR	~2.1:1	~1.8:1	~2.5:1
Efficiency (%)	~56.4	~56.1	~37.8
Peak Gain (dBi)	~-2.6	~-3.2	~-1.4
Average Gain (dB)	~-2.5	~-2.5	~-4.2
Impedance (Ohm)	50		
Polarisation	Linear		
Radiation Pattern	Omni-Directional		
Max. Input Power (W)	25		
Connector Type	SMA-Male		
Cable Length	200 cm		
Cable Type	DACAR100		

Antenna Measurement Conditions:

Mounted on 30 x 30 cm Ground Plane

DACAR100 200 cm Cable Length

Measured in Certified CTIA 3D Anechoic Chamber

2. Mechanical and environmental specifications

Specifications	OPT1-ANT-4GS-21
Mounting Type	Screw Mount
Dimensions (mm)	Ø 50 x 50.8
Rec. Tighten Torque (Nm)	3 Nm
Radome Type	ASA
Radome Color	Black
Gasket	Double Sided Foam
Operating Temperature (C)	-40 to +85
Storage Temperature (C)	-40 to +85
Substance Compliance	RoHS
Certificates	IP67, IP69

3. Antenna parameters

Cable 1: CELLULAR/LTE

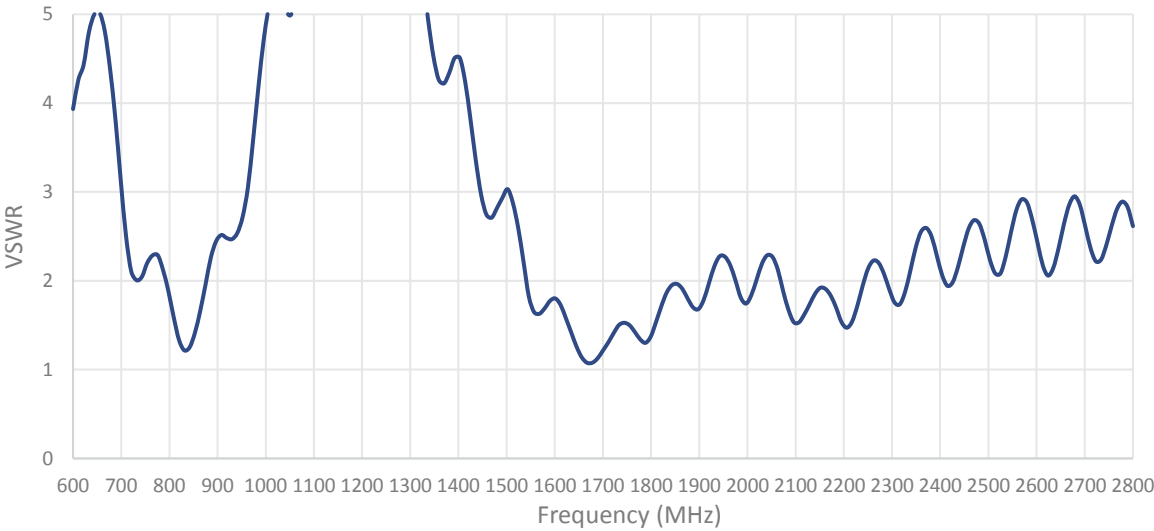
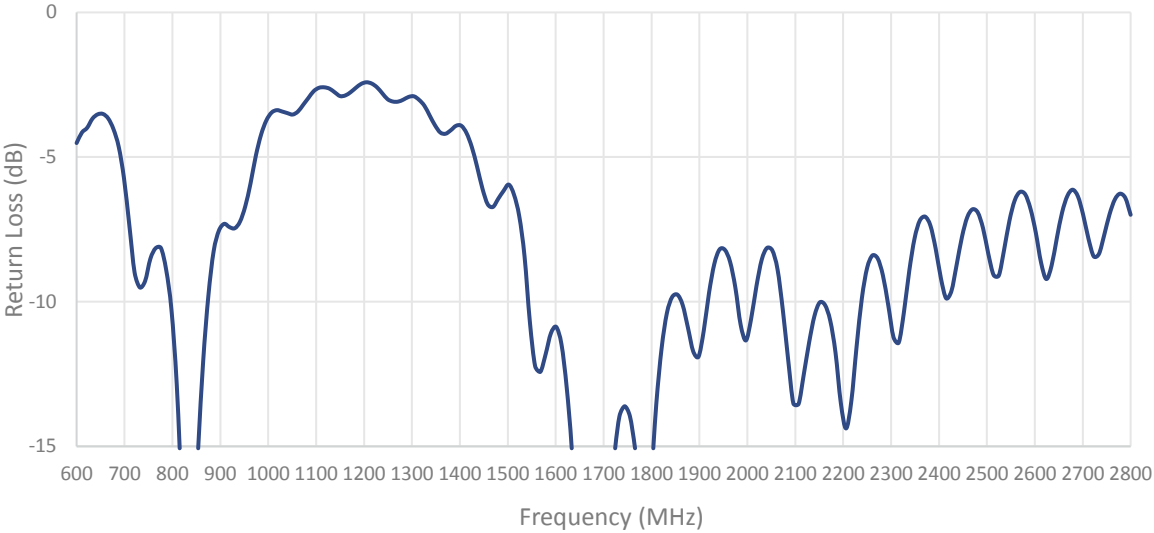

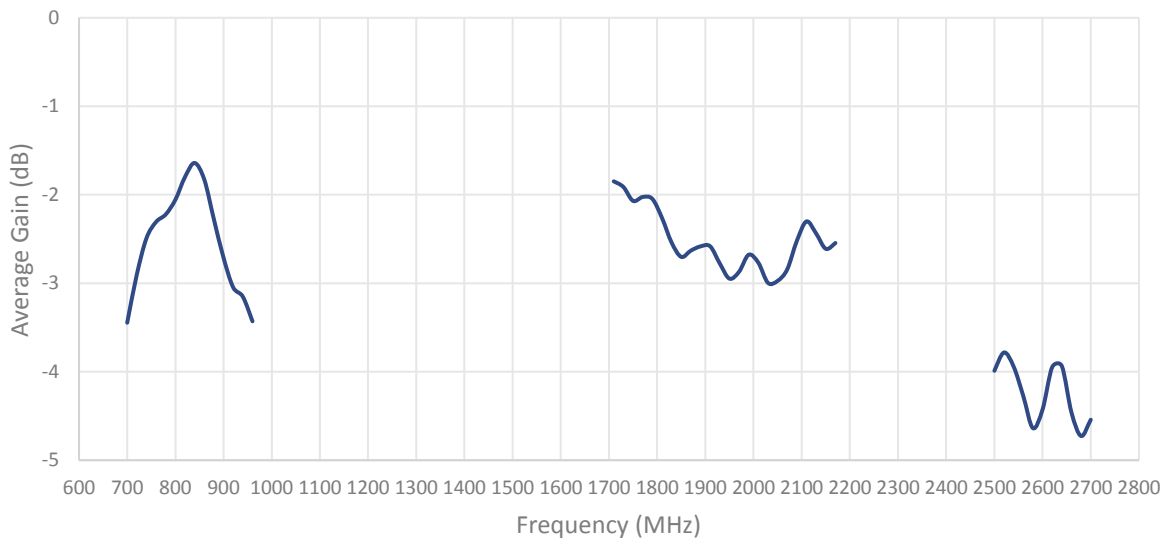
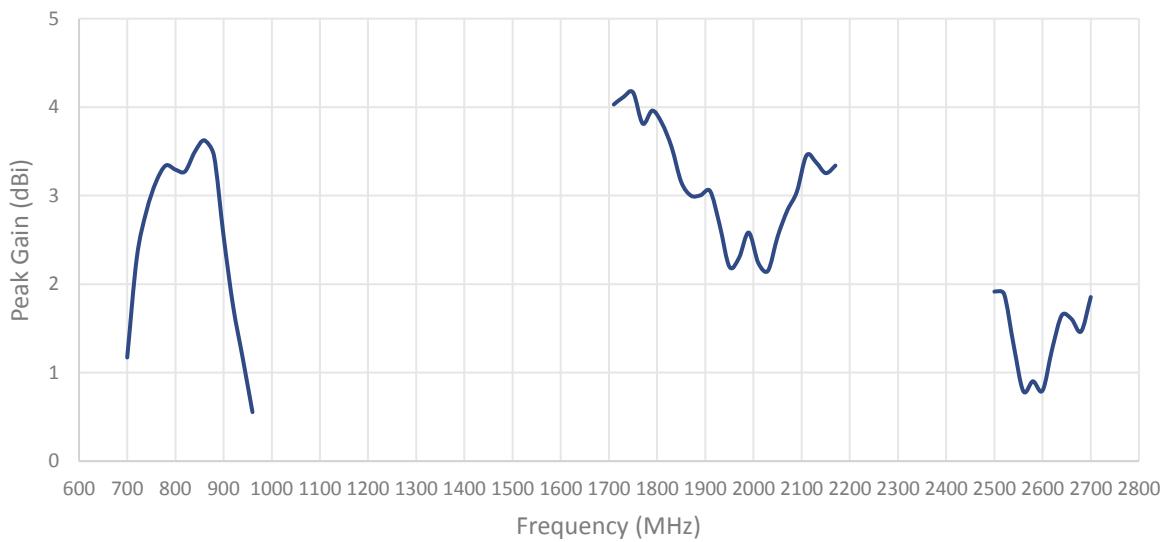
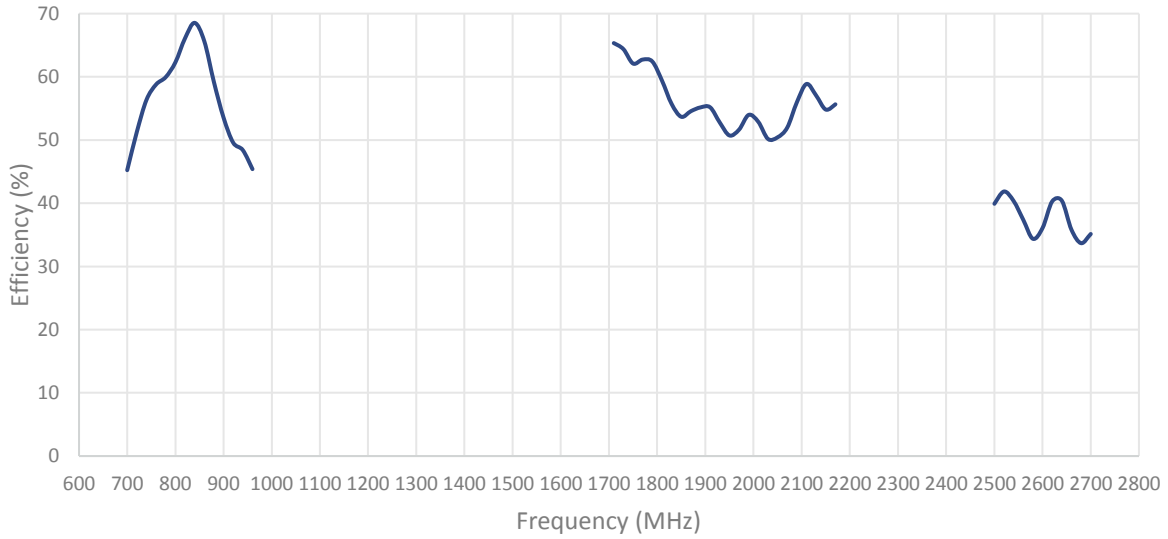

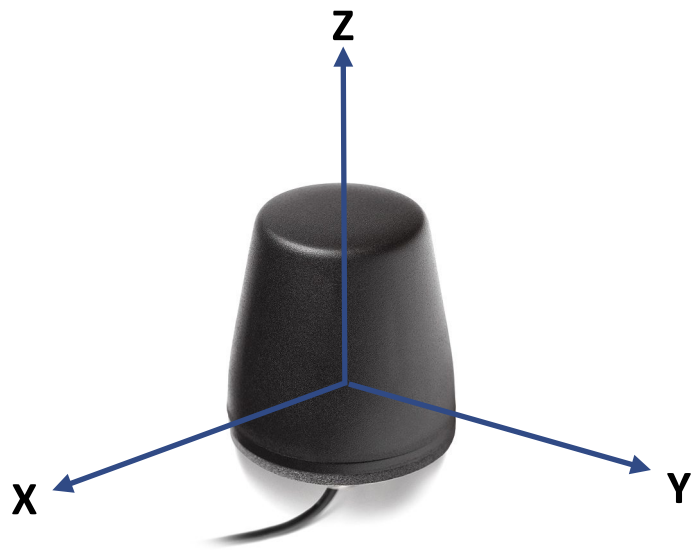

Radiation pattern reference

Table 1: CELLULAR/LTE

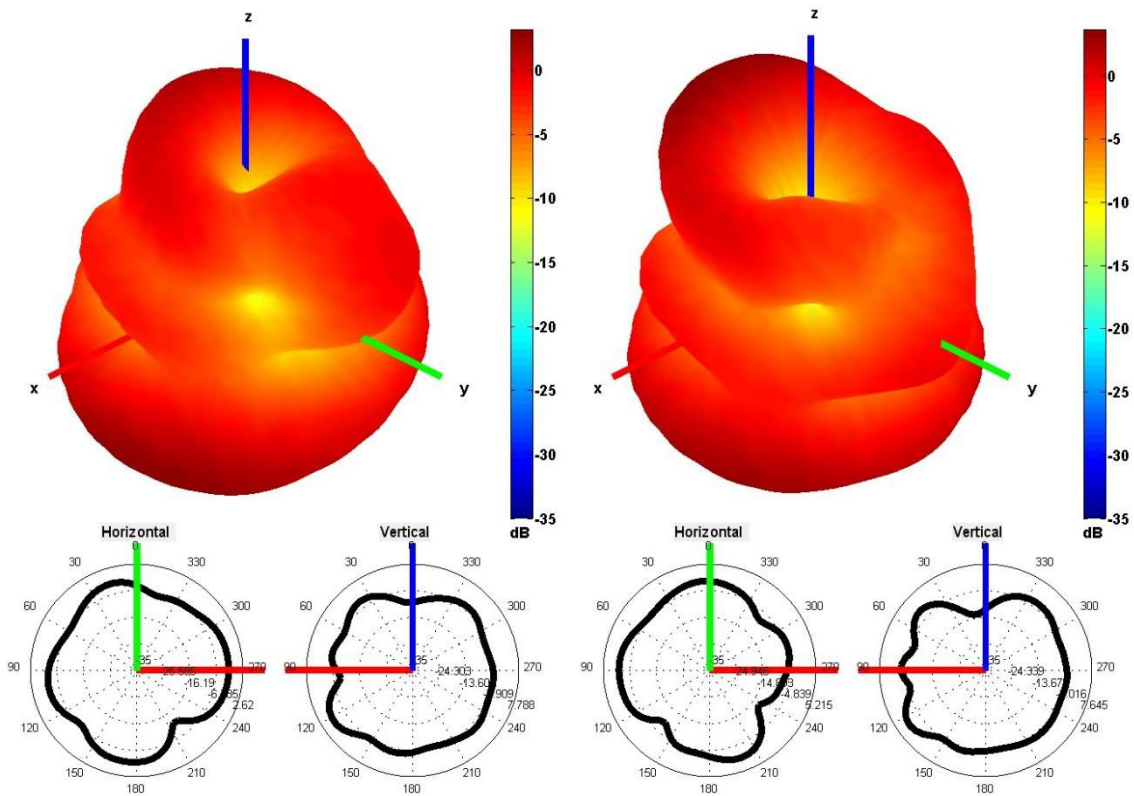

750 and 850 MHz Radiation pattern

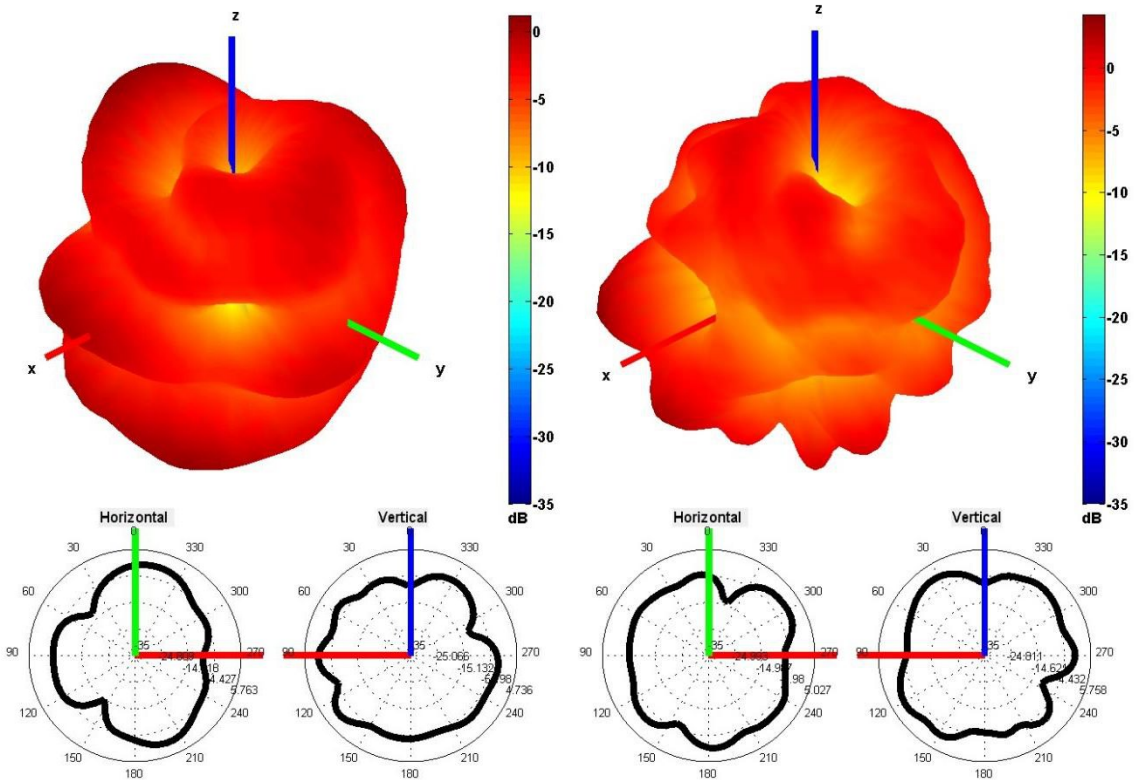

940 and 1750 MHz Radiation pattern

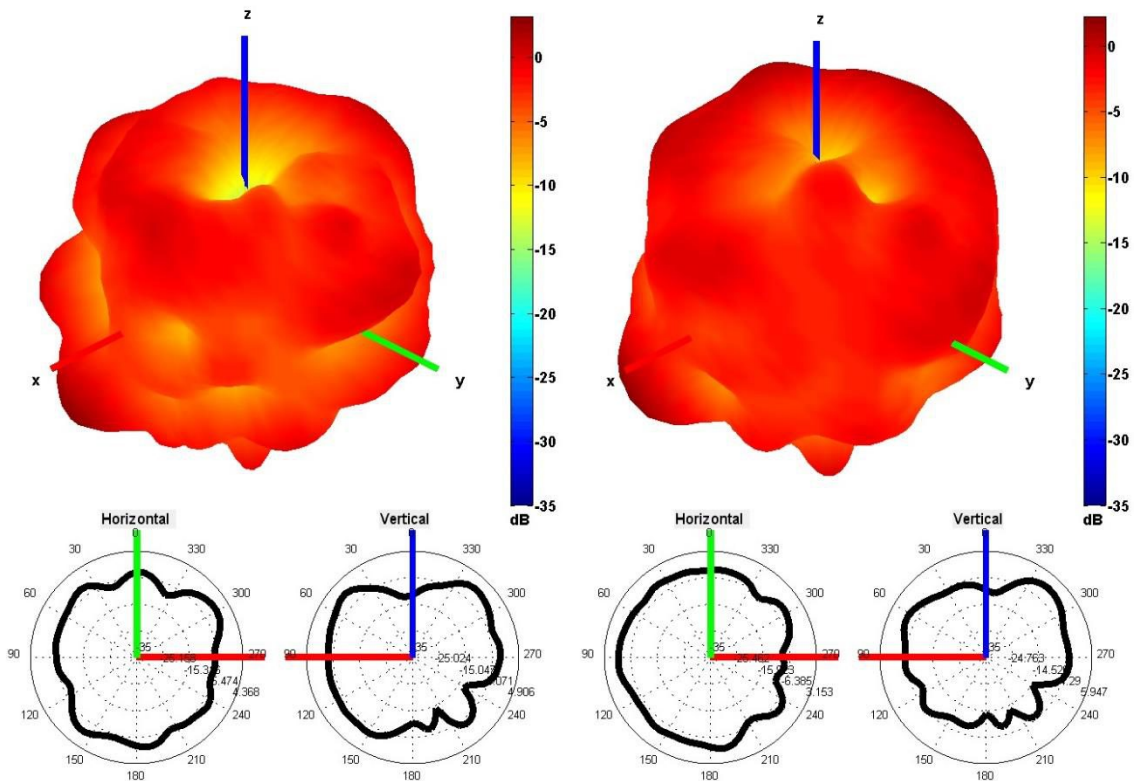

1850 and 1950 MHz Radiation pattern

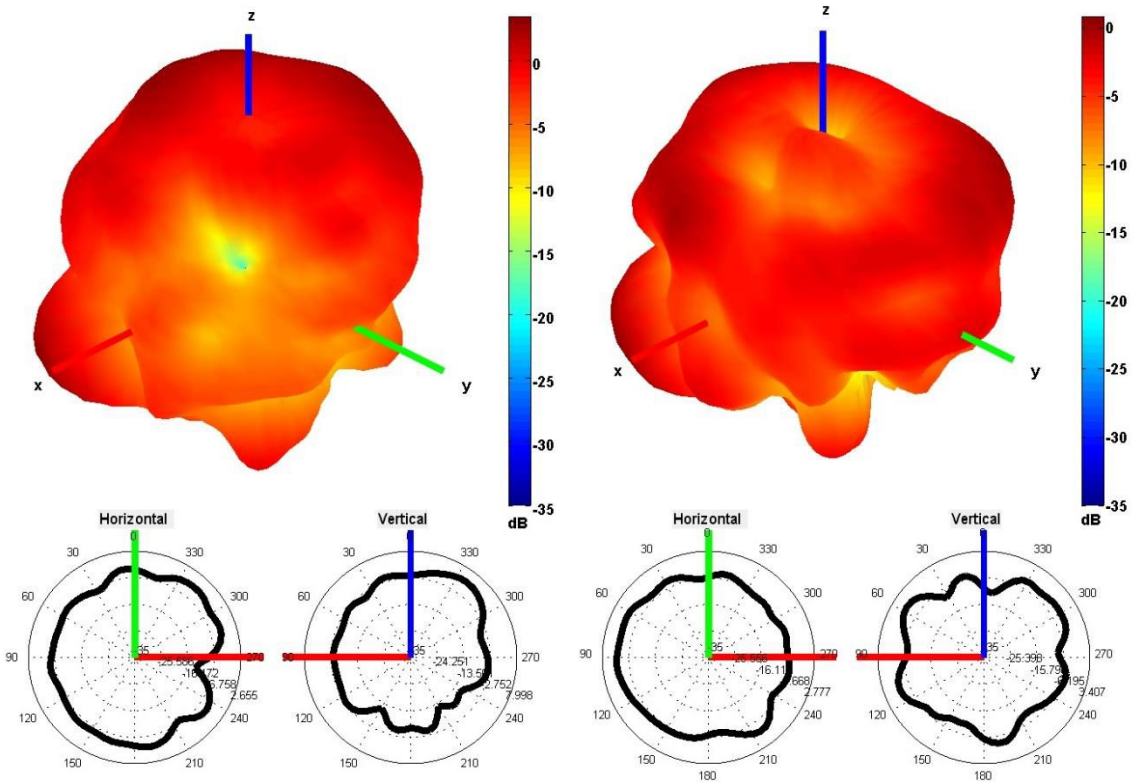

2100 and 2600 MHz Radiation pattern

4. Antenna drawings

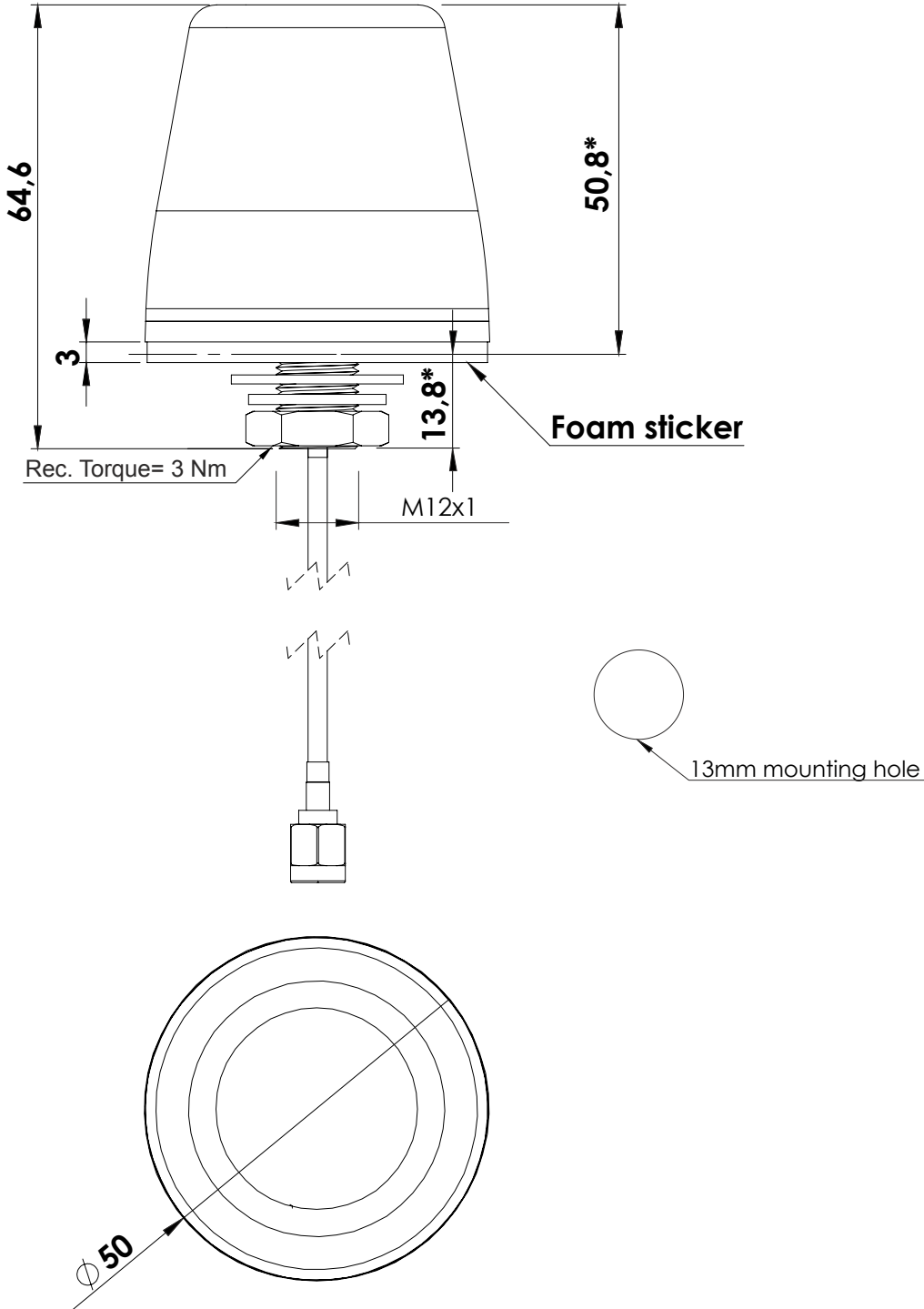

Note: Dimensions are in millimeters
*Dimensions are after mounting
**Reccomended Torque= 3 Nm

5. Antenna Images

