

Hardware Manual

LTE Industrial Connectivity Gateway **ICR-1642**



© 2026 Advantech Czech s.r.o. No part of this publication may be reproduced or transmitted in any form or by any means, electronic or mechanical, including photography, recording, or any information storage and retrieval system, without prior written consent. Information in this manual is subject to change without notice and does not represent a commitment by Advantech.

Advantech Czech s.r.o. shall not be liable for any incidental or consequential damages arising from the use, performance, or furnishing of this manual.

All brand names used in this manual are registered trademarks of their respective owners. The use of trademarks or other designations in this publication is for reference purposes only and does not imply endorsement by the trademark holder.

Used symbols

Important



Important — Indicates a risk to personal safety or potential damage to the router. Follow these instructions precisely to prevent injury or equipment damage.

Warning



Warning — Highlights conditions that may cause malfunction, loss of data, or unexpected behavior in specific situations. Read carefully before proceeding.

Info



Info — Provides helpful tips, context, or references that improve understanding but are not strictly required to complete the task.

Contents

| | |
|---|-----------|
| 1. Product Overview | 1 |
| 1.1 Document Contents | 1 |
| 1.2 Product Introduction | 2 |
| 1.3 Hardware Overview | 3 |
| 1.4 Order Codes | 5 |
| 1.5 Package Contents | 6 |
| 1.6 Product Dimensions | 7 |
| 1.7 Mounting Recommendations | 10 |
| 1.8 Wall Mounting | 11 |
| 1.9 DIN Rail Mounting | 12 |
| 1.10 Product Label | 13 |
| 1.11 First Use | 14 |
| 2. Hardware Functionality | 15 |
| 2.1 SIM Card Slots | 15 |
| 2.2 Antennas Interfaces | 16 |
| 2.3 Ethernet Interfaces | 16 |
| 2.4 Power Supply | 17 |
| 2.5 DIN & DOUT Interfaces | 18 |
| 2.6 Serial Interfaces | 19 |
| 2.7 LED Status Indication | 20 |
| 2.8 Reset Functions | 21 |
| 3. Technical Parameters | 22 |
| 3.1 Basic Technical Parameters | 22 |
| 3.2 Standards and Regulations | 23 |
| 3.3 Type Testing and Environmental Conditions | 24 |
| 3.4 Parameters of Cellular Module for ICR-16xx-EU | 25 |
| 3.5 Parameters of Cellular Module for ICR-16xx-CN | 26 |
| 3.6 Parameters of GNSS (for ICR-16xxG only) | 27 |
| 3.7 Parameters of Wi-Fi (for ICR-16xxW only) | 28 |
| 3.8 Parameters of I/O Ports | 29 |
| 3.9 Parameters of Serial Interfaces | 29 |
| 3.10 System Configuration | 29 |
| Appendix A: Troubleshooting | 30 |
| Appendix B: Customer Support | 32 |
| Appendix C: Regulatory & Safety Information | 33 |
| Appendix D: Related Documents | 35 |

List of Figures

| | | |
|----|--|----|
| 1 | Router hardware overview – front view | 3 |
| 2 | Router hardware overview – rear view | 4 |
| 3 | Router dimensions – front, top and side view for basic set | 7 |
| 4 | Router dimensions – front, top and side view with wall-mounting holder | 8 |
| 5 | Router dimensions – front, top and side view with DIN holder | 9 |
| 6 | Wall Mounting Clip | 11 |
| 7 | Default position of the DIN rail clip | 12 |
| 8 | Product label | 13 |
| 9 | SIM card insertion | 15 |
| 10 | Ethernet connector pinout (RJ45 socket) | 16 |
| 11 | Power connector pinout | 17 |
| 12 | Grounding screw position | 17 |
| 13 | I/O connector pinout | 18 |
| 14 | Functional block diagram of the digital interface | 18 |
| 15 | Serial connector pinout | 19 |
| 16 | Resetting the router | 21 |

List of Tables

| | | |
|----|---|----|
| 1 | Router hardware overview – front view | 3 |
| 2 | Router hardware overview – rear view | 4 |
| 3 | Order code overview | 5 |
| 4 | Package contents | 6 |
| 5 | Ethernet connector pinout (RJ45 socket) | 16 |
| 6 | Power connector pinout | 17 |
| 7 | I/O Ports Pinout | 18 |
| 8 | RS232 connection | 19 |
| 9 | RS485 connection | 19 |
| 10 | LED status indication | 20 |
| 11 | LED status indication | 20 |
| 12 | Basic parameters | 22 |
| 13 | Standards and regulations | 23 |
| 14 | Type testing and environmental conditions | 24 |
| 15 | Technical parameters of the cellular module | 25 |
| 16 | Technical parameters of the cellular module | 26 |
| 17 | Technical parameters of GNSS | 27 |
| 18 | Technical parameters of Wi-Fi | 28 |
| 19 | Electrical characteristics of digital input | 29 |
| 20 | Parameters of serial interfaces | 29 |
| 21 | System configuration | 29 |

1. Product Overview

1.1 Document Contents

This manual provides comprehensive hardware information for Advantech ICR-1642 routers, covering the following key areas:

- **Product Overview** – Includes essential product details such as ordering codes, product revision history, package contents, physical dimensions, and mounting instructions.
- **Hardware Functionality** – Offers a detailed description of all hardware components, including SIM card slots, antenna connectors, Ethernet ports, power supply options, LED status indicators, reset button functionalities, and other physical interfaces.
- **First Use** – Provides step-by-step instructions for the initial setup and basic operation of the router.
- **Technical Specifications** – Lists key technical parameters, applicable standards and regulatory compliance information, results of type tests, cellular module specifications, and detailed interface parameters.

1.2 Product Introduction

Industrial connectivity gateway ICR-1642 series is designed for wireless communication to enable connection of IP devices and serial buses to a cellular network.

Industrial M2M and IoT applications include kiosks, industrial PCs, HMIs, traffic controllers, meters, UPS systems, and much more.

The peak **downlink** data rate for **LTE** Cat.4 is approximately **150 Mbps**. Also in the **uplink**, **LTE** Cat.4 provides a peak data rate of **50 Mbps**.

The router is equipped with two Gigabit Ethernet ports and with digital I/O (1x DI, 1x DO) and Serial (**1xRS232** + **1xRS485**) connectivity. The gateway supports **VPN** tunnel creation using various protocols to ensure safe communications. The gateway provides diagnostic functions which include automatic monitoring of the wireless and wired connections, automatic restart in case of connection losses, and a hardware watchdog that monitors the router status.

The connectivity gateway is based on ICR-OS operation system. Open Linux platform enable wide possibilities of programming customer SW applications in **Python, C/C++**. Router supports uploading of certain Router Apps (basic features only), that would extend standard firmware functionalities. Existing app library ready for free download by customer contains already developed software apps to enhance specific router functionality.

Compatibility with Advantech's **remote device management** platform, [WebAccess/DMP](#), offers extensive device management and monitoring, ensuring that devices remain up-to-date and secure.

1.3 Hardware Overview

In this chapter, all components of the router case are described, including links to chapters that provide more details.



Figure 1: Router hardware overview – front view

| # | Item | Type | Description |
|---|--------------|----------------|--|
| 1 | RST | — | Button to reboot the router or restore default settings; see Chapter 2.8. |
| 2 | LEDs | — | Status LED indicators; see Chapter 2.7. |
| 3 | GND Screw | M3 | Ensure proper grounding; refer to Chapter 2.4. |
| 4 | PWR | 2-pin terminal | Power supply socket; see Chapter 2.4. |
| 5 | Serial & I/O | 10-p term. | 1 RS232, 1 RS485, 1 digital input, and 1 digital output interfaces. See Chapter 2.6 for serial interface details, Chapter 3.8 for I/O parameters, and Chapter 3.9 for serial interface parameters. |
| 6 | ETH0, ETH1 | RJ45 | 1 Gb Ethernet LAN interfaces; see Chapter 2.3. |
| 7 | Wall Clip | — | Wall mounting clip, included as standard accessories; see Chapter 1.8. |

Table 1: Router hardware overview – front view



Figure 2: Router hardware overview – rear view

| # | Item | Type | Description |
|----|-----------|-----------|---|
| 8 | DIN Clip | — | DIN mounting clip, not included as standard accessories, can be ordered optionally; see Chapter 1.9. |
| 9 | SIM Slots | Micro SIM | Two Micro SIM card slots; details in Chapter 2.1. |
| 10 | ANT, DIV | — | Connectors for both the main and diversity antennas of the cellular module. Refer to Chapter 2.2 for details, Chapter 3.4 & 3.5 for cellular module parameters. |

Table 2: Router hardware overview – rear view

1.4 Order Codes

The table below provides an overview of the order codes.

| Order Code | Configuration |
|-----------------------------|---|
| ICR-1642-EU-A | LTE Connectivity Gateway with 2 x Gigabit Ethernet port and 1xRS232+1xRS485+1xDI+1xDO ports for EMEA , certified with CE/UKCA. |
| ICR-1642-CN-A | LTE Connectivity Gateway with 2 x Gigabit Ethernet port and 1xRS232+1xRS485+1xDI+1xDO ports for China . |
| ICR-1642W-EU-A ¹ | LTE Connectivity Gateway with 2 x Gigabit Ethernet port and 1xRS232+1xRS485+1xDI+1xDO ports, Wi-Fi for EMEA , certified with CE/UKCA. |
| ICR-1642G-EU-A ¹ | LTE Connectivity Gateway with 2 x Gigabit Ethernet port and 1xRS232+1xRS485+1xDI+1xDO ports, GNSS for EMEA , certified with CE/UKCA. |
| ICR-1642W-CN-A ¹ | LTE Connectivity Gateway with 2 x Gigabit Ethernet port and 1xRS232+1xRS485+1xDI+1xDO ports, Wi-Fi for China . |
| ICR-1642G-CN-A ¹ | LTE Connectivity Gateway with 2 x Gigabit Ethernet port and 1xRS232+1xRS485+1xDI+1xDO ports, GNSS for China . |

Table 3: Order code overview

¹Availability may vary. Please consult your local sales representative for more information.

1.5 Package Contents

The standard set of the router includes the following items, as listed in the table below:







| Item# | Description | Figure | Q'ty |
|-------|--|---|------|
| 11 | Router |  | 1 pc |
| 12 | Wall Mount Kit (packed in accessory box, including 4 screws of type M3 x 5L) |  | 1 pc |
| 13 | 2-pin terminal block for power supply (installed on the router) |  | 1 pc |
| 14 | 10-pin terminal block for Serial and IO (installed on the router) |  | 1 pc |
| 15 | LTE Antennas (packed in accessory box) |  | 2 pc |
| 16 | WiFi Antenna (packed in accessory box, WiFi model only) |  | 1 pc |
| 17 | Printed <i>Quick Start Guide Leaflet</i> |  | 1 pc |

Table 4: Package contents

1.6 Product Dimensions

For the dimensions of the router see the figures below. Note that all sizes are measured in millimeters.

Basic Set

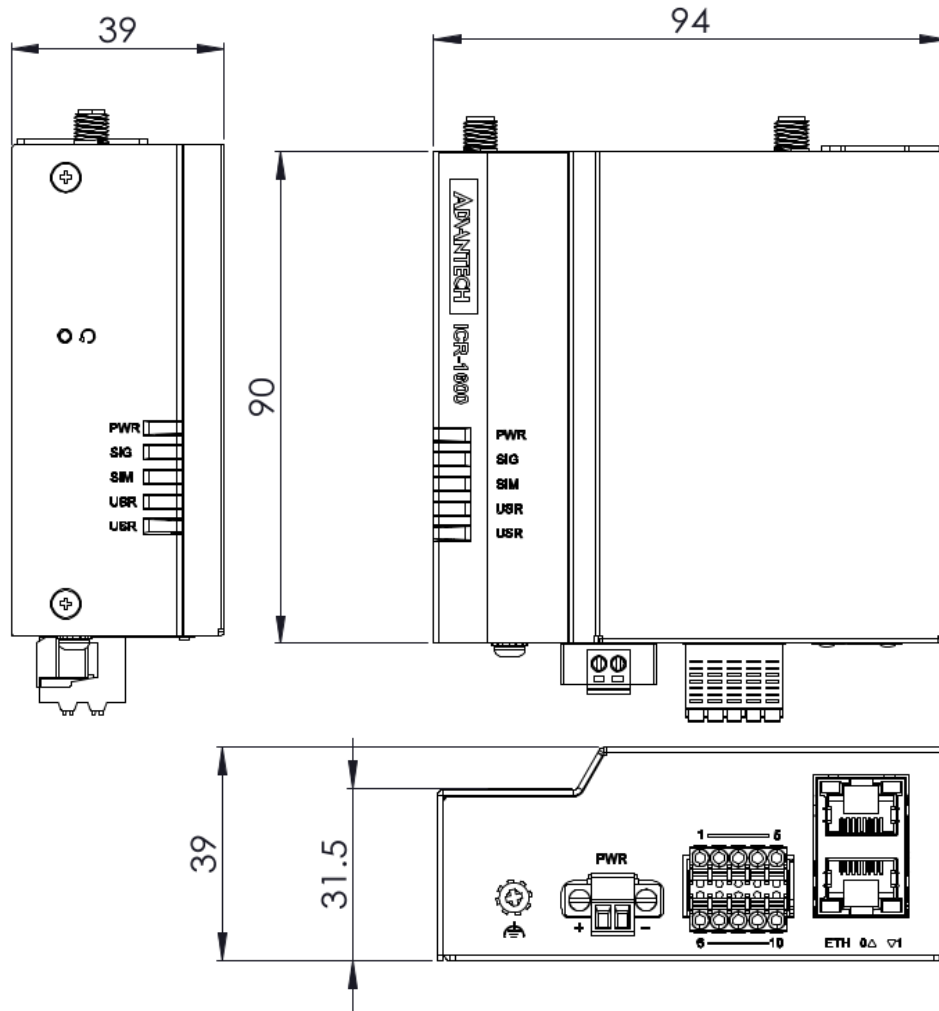

Figure 3: Router dimensions – front, top and side view for basic set

Wall Mount Clip Variant

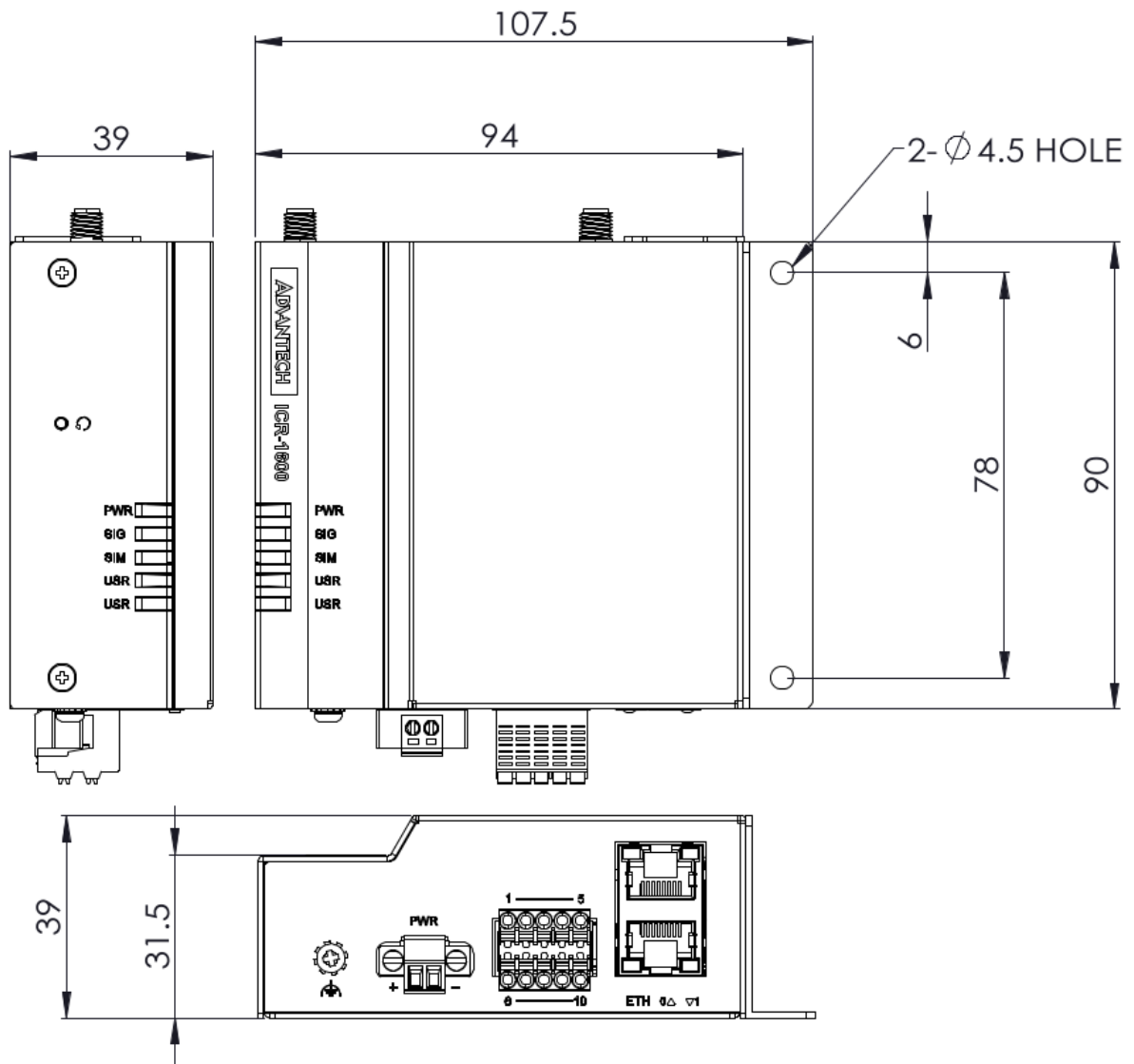

Figure 4: Router dimensions – front, top and side view with wall-mounting holder

DIN Rail Clip Variant (Optional)

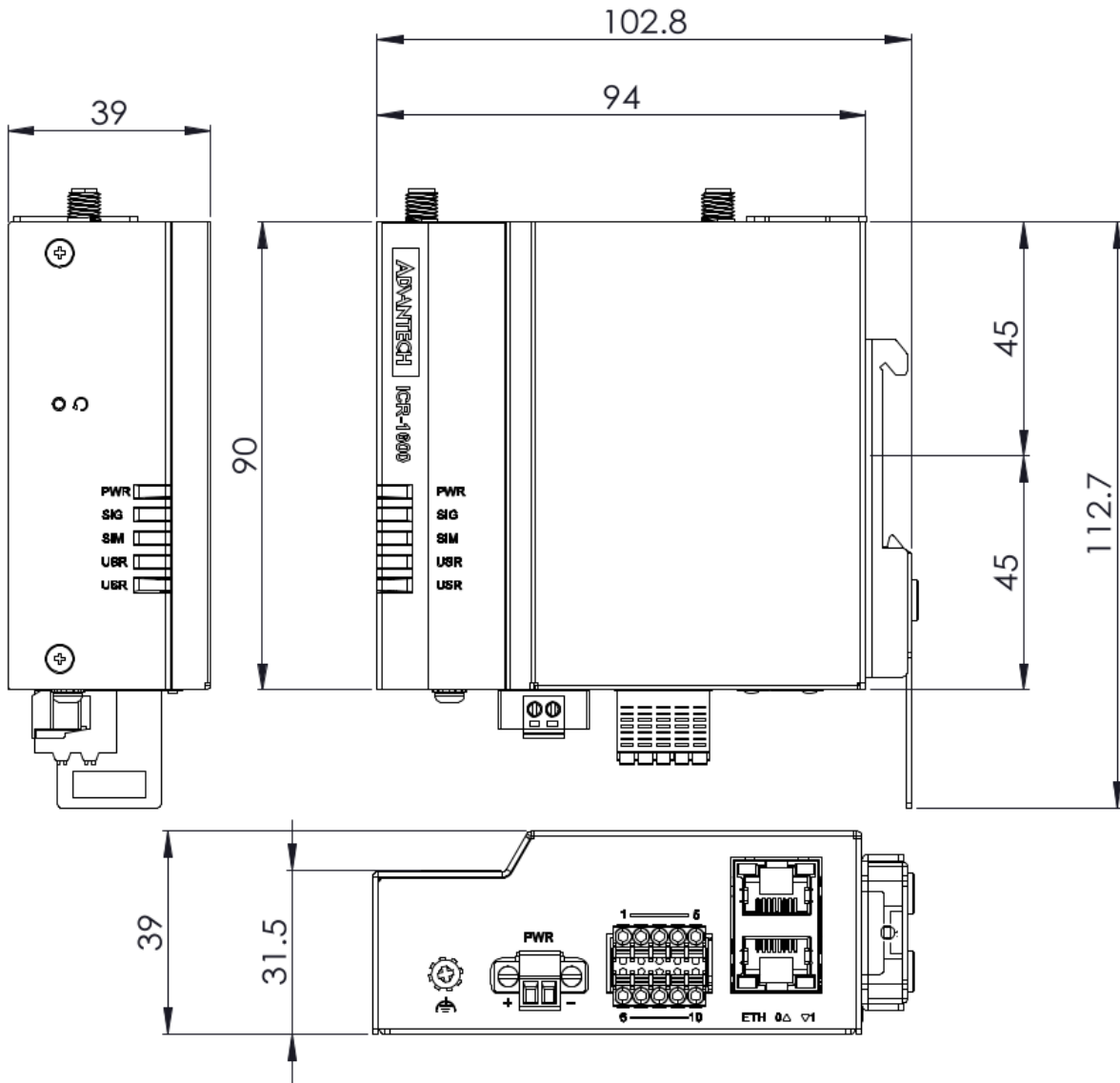

Figure 5: Router dimensions – front, top and side view with DIN holder

1.7 Mounting Recommendations

The router can be placed in the following ways:

- On a flat surface.
- On a wall using the wall-mounting clip (refer to Chapter 1.8).
- On a DIN rail EN 60715 with the metal DIN rail clip (refer to Chapter 1.9).

For most applications involving a built-in router within a switchboard, two types of environments are typically encountered:

- A non-public industrial environment with low voltage but high interference.
- A public environment with low voltage and without high interference.

For both of these environments, it's feasible to mount the router to a switchboard, eliminating the need for immunity examination or EMC-related issues as per EN 61439-1:2011 standards.

Warning

To comply with the EN 61439-1:2011 specification, follow these assembly instructions when attaching a router to a switchboard:

- When using whip antennas, maintain a minimum distance of 6 cm from cables and metal surfaces on all sides to avoid interference. If an external antenna is used apart from the switchboard, a lightning conductor is necessary.
- When mounting a router on sheet steel, consider using a cable antenna.

For all cables, it's recommended to bundle them, following these guidelines:

- The combined length of the cable bundle (power supply and data cables) should not exceed 1.5 m. If data cable length surpasses 1.5 m or if the cable runs toward the switchboard, installing surge protectors is advisable.
- Data cables must not be bundled with mains voltage cables (230 V/50 Hz or 120 V/60 Hz).
- Ensure sufficient space is left between each connector for cable handling.
- For proper router functionality, use an earth-bonding distribution frame to ground the grounding screw (refer to Chapter 2.4).

1.8 Wall Mounting

Info



The wall-mounting clip is included as a standard accessory (packed in the accessory box, including 4 screws of type M3 x 5L).

The router can be affixed to a wall or another surface using the wall-mounting clip. The delivered wall-mounting clip can be assembled to the router as shown in Figure 6.

The wall-mounting clip features two holes with a diameter of 4.5 millimeters for screw placement. For precise mounting dimensions, refer to Figure 4 in Chapter 1.6.

Warning



When attaching the wall-mounting clip, tighten the screws with a maximum torque of 0.6 Nm (6 kg.cm).



Figure 6: Wall Mounting Clip

1.9 DIN Rail Mounting

Info

The DIN rail mounting clip is not included as a standard accessory; it can be ordered separately under P/N OPT1-DIN-ICR1X-00.

You can attach the DIN rail clip to the router for mounting it onto a DIN rail that complies with the 60715 standards. The default position of the clip is depicted in Figure 7. If necessary, the clip can also be rotated into all four positions.

Warning

When attaching the clip, use 4 screws of type M3 x 5L, and tighten the screws with a maximum torque of 0.6 Nm (6 kg.cm).

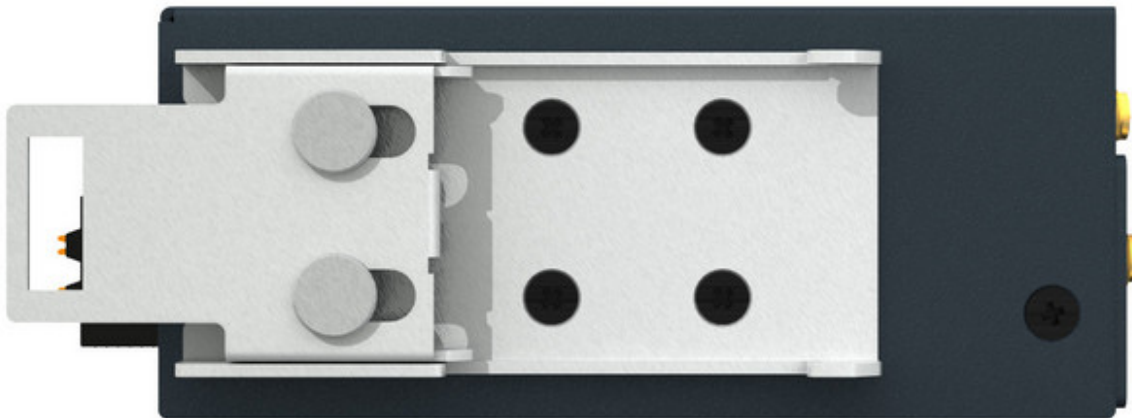

Figure 7: Default position of the DIN rail clip

1.10 Product Label

The figure below shows an example of the product labels with all the information printed on them.



Figure 8: Product label

1.11 First Use

You can perform the initial configuration of the router using a web browser on your PC. This interface enables router monitoring, configuration, and administration.

Warning

- Before putting the router into operation, ensure that all components required for running your applications are connected. Refer to Chapter [1.3 Hardware Overview](#) for an overview of the hardware.
- Do not operate the router without an antenna connected to the main antenna connector. Transmitted energy will be reflected by an open connector, which could potentially damage the equipment.
- This device utilizes radio frequency bands that may be subject to specific usage restrictions in certain European Union countries (e.g., indoor use only). Please refer to [Appendix C](#) for detailed regulatory information before operation.

The procedure for connecting to a new router is described in the *Configuration Manual [1]*, Chapter *Getting Started* → *Configuration Environments* → *Web Interface Initial Setup*. This manual also provides detailed descriptions and examples of router configuration using the web interface.

2. Hardware Functionality

See Chapter 1.3 for an overview of the product's hardware, along with links to chapters offering detailed explanations.

2.1 SIM Card Slots

Slots for two SIM cards are located on the router beneath a metal cover. If you plan to use this device for cellular network communication, insert an activated data-provisioned SIM card into the SIM card slot. You have the option to install two SIM cards simultaneously for utilizing the switching feature. The SIM cards can have different Access Point Names (APNs) configured. The procedure for changing SIM cards is outlined below. If the SIM requires a PIN, input it in the router's web interface (*Administration* → *Unlock SIM Card*).

Info

Type of SIM card: Micro SIM (3FF) 15.0 × 12.0 × 0.76 mm.

Warning

Inserting the SIM card:

- Always disconnect the router from the power supply before handling the SIM card.
- Unscrew the two screws on the SIM card cover and remove the cover.
- To remove an inserted SIM card, use the flat end of a spudger or your fingernail to press the SIM card slightly into its slot until you hear a click. Upon hearing the click, release the card, and it will pop out of its slot.
- To insert a SIM card, push the card into the slot until it clicks into place.
- Put the cover back and secure it with the two screws.



Figure 9: SIM card insertion

2.2 Antennas Interfaces

The ANT and DIV SMA female connectors are intended for connecting the main and diversity cellular antennas to the router. Additionally, SMA/RP-SMA¹ female connectors labeled *AUX* are provided for connecting GNSS/Wi-Fi antennas on models that support Wi-Fi or GNSS.

Warning

Do not run the router without connected cellular antennas as the energy from the transmission is effectively reflected by the open end and can damage the equipment.

Info

Recommended tightening moment for screwing the antenna to the SMA connector is 0.9 Nm.

2.3 Ethernet Interfaces

The RJ45 panel socket is used for one ETH0 and one ETH1 Ethernet interfaces. The pinout of the socket is shown in Figure 10 and described in Table 5.

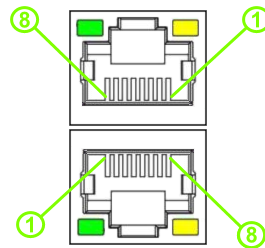

Figure 10: Ethernet connector pinout (RJ45 socket)

| Pin | 10base-T & 100base-T | 1000base-T |
|-----|----------------------|--------------------------------|
| 1 | Tx+ (Transmit Data+) | BI_DA+ (BiDirectional pair A+) |
| 2 | Tx- (Transmit Data-) | BI_DA- (BiDirectional pair A-) |
| 3 | Rx+ (Receive Data+) | BI_DB+ (BiDirectional pair B+) |
| 4 | — | BI_DC+ (BiDirectional pair C+) |
| 5 | — | BI_DC- (BiDirectional pair C-) |
| 6 | Rx- (Receive Data-) | BI_DB- (BiDirectional pair B-) |
| 7 | — | BI_DD+ (BiDirectional pair D+) |
| 8 | — | BI_DD- (BiDirectional pair D-) |

Table 5: Ethernet connector pinout (RJ45 socket)

Info

The isolation barrier of the Ethernet ports against the ground is 1500 V.

¹SMA female for GNSS, RP-SMA female for Wi-Fi

2.4 Power Supply

A two-pin terminal connector (pitch 3.5 mm) is utilized to power the router. The corresponding connector is included as a standard accessory with the router.

| Pin | Signal mark | Description |
|-----|-------------|---|
| 1 | VCC(+) | Positive pole of DC supply voltage (+9 to +48 V DC) |
| 2 | GND(-) | Negative pole of DC supply voltage |

Table 6: Power connector pinout

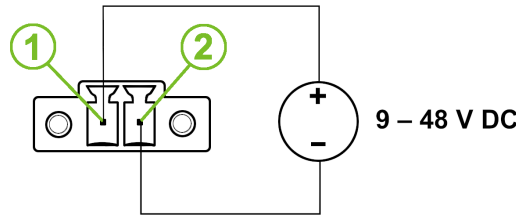

Figure 11: Power connector pinout

The required power supply voltage for the router ranges between +9 V and +48 V DC. Refer to the connection scheme in Figure 11 for proper setup. The router is equipped with built-in protection against reversed polarity, functioning without signaling. To guarantee correct operation, the power source must be capable of providing a sufficient amount of energy, as detailed in the consumption section of Chapter 3.1.

Warning



Grounding the router using the grounding screw eliminates the protection against reversed polarity. Ensure the negative pole of the DC power supply shares the same voltage reference as the grounding screw. A voltage difference between these points may damage the router, necessitating repairs exclusively by an authorized service center.

Warning



Unit has to be supplied by a power supply specified as a Limited Power Source (LPS) or CEC/NEC Class 2 source of supply.

Info



The power supply (common pole) is not connected to the metal case of the router nor to the internal ground, see Figure 14.

If recommended for the installation environment, protect the router by properly grounding it using the grounding screw, as depicted in Figure 12. The maximum tightening torque for the grounding screw is 0.6 Nm (6 kg.cm).



Figure 12: Grounding screw position

2.5 DIN & DOUT Interfaces

The pins of I/O interface are physically connected to the 10-pin terminal block panel socket. The pinout of the I/O interface is described in Figure 13 and Table 7.

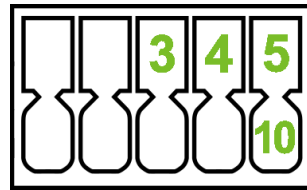

Figure 13: I/O connector pinout

| Pin | Signal mark | Description |
|------|-------------|-------------------------------|
| 3 | BIN | Digital input |
| 4 | BOUT | Digital output |
| 5,10 | GND | Ground (common negative pole) |

Table 7: I/O Ports Pinout

Info

The I/O interface is not electrically isolated from the router.

The I/O user interface is designed for digital input processing and digital output control. For detailed electrical parameters see Chapter 3.8. The functional scheme of connection for the digital input and digital output is in Figure 14.

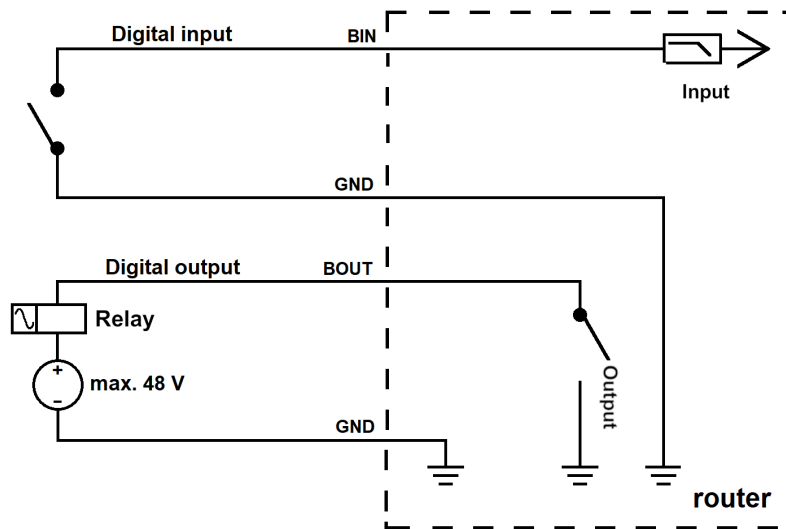

Figure 14: Functional block diagram of the digital interface

2.6 Serial Interfaces

Two independent serial interfaces are connected to the 10-pin terminal block panel socket.

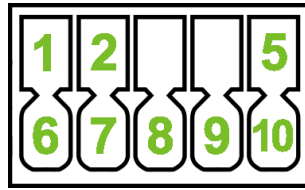

Figure 15: Serial connector pinout

The RS232 interface can be configured on the web GUI by navigating to *Configuration* → *Expansion Port 1*. For the pinout, refer to Table 8. .

| Pin | Signal mark | Description |
|-----|-------------|-------------|
| 6 | TXD | OUT |
| 7 | RXD | IN |
| 8 | RTS | OUT |
| 9 | CTS | IN |
| 10 | GND | GROUND |

Table 8: RS232 connection

The RS485 interface can be configured on the web GUI by navigating to *Configuration* → *Expansion Port 2*. For the pinout, refer to Table 9.

| Pin | Signal mark | Description |
|-----|-------------|-------------|
| 1 | D (+) | IN/OUT |
| 2 | D (-) | IN/OUT |
| 5 | GND | GROUND |

Table 9: RS485 connection

Info

The serial interfaces are not electrically isolated from the router.

2.7 LED Status Indication

There are status LEDs on the top side of the router to provide router status information. Moreover, ETH0 and ETH1 connectors, located on the front panel, have two additional LEDs providing information about the port status.







| | Caption | Color | State | Description |
|---|--------------|--|--|---|
|  | PWR | Green Green Off | On Blinking Off | Powered up, the system is booting up. System is ready and operating normally. No power. |
|  | SIG | Green Orange Red Off | On / blinking On / blinking On / blinking Off | Good cellular signal. Fair cellular signal. Poor cellular signal. No cellular link. |
|  | SIM | Green Orange Green Orange Red Off | Blinking Blinking On On Fast blinking Off | SIM 1 is selected, waits for data connection. SIM 2 is selected, waits for data connection. Connects through SIM 1. Connects through SIM 2. Missing SIM card or PIN code problem. No SIM card is selected. |
|  | USR | Green | — | The function of these LEDs are user-defined. |
|  | ETH0 ETH1 | Green Green | On Off | Selected 1 Gbps bit rate. Selected 100/10 Mbps bit rate. |
|  | ETH0 ETH1 | Yellow Yellow Yellow | On Brief blinks Off | off The network cable is connected. Data transmission. The network cable is not connected. |

Table 10: LED status indication

The following describes when *USR* is defined as Serial or Wi-Fi:



| | Caption | Color | State | Description |
|---|------------|-----------------------|-----------------------|---|
|  | Serial/USR | Green Off | Blinking Off | Serial Port 1 TX/RX transmitting data. No RS232/RS485 data. |
|  | Wi-Fi/USR | Green Green Off | On Blinking Off | AP or STA mode is selected. Transmitting data. No AP or STA mode is selected. |

Table 11: LED status indication

2.8 Reset Functions

The *RST* button has multiple functions. For more details, refer to the configuration manual [1], Chapter *Introduction* → *Device* → *Reset*.

Info

Use a narrow screwdriver or a small tool to press the *RST* button.



Figure 16: Resetting the router

3. Technical Parameters

3.1 Basic Technical Parameters

| Parameter | Description |
|---|--|
| Temperature range | Operating: -40 °C to +75 °C (-40 °F to +167 °F) Storage: -40 °C to +85 °C (-40 °F to +185 °F) |
| Humidity | Operating: 5 to 95 % relative humidity non condensing Storage: 5 to 95 % relative humidity non condensing |
| Altitude | Operating: 2000 m / 70 kPa |
| Degree of protection | IP30 |
| Supply voltage | 9 – 48 V DC |
| Consumption for non-Wi-Fi / Wi-Fi version | Idle: 2.8 W / 3.8 W Average: 3.5 W / 4.5 W Maximum: 3.8 W / 5.5 W |
| Dimensions of device (w/o clips) | 94 × 39 × 90 mm (3.7" × 1.53" × 3.54") |
| DIN rail clip specification | DIN 30 mm (DIN clip is an optional) |
| Weight | ICR-16XX: 331 g (0.73 lbs) (excluding below accessories) LTE Antenna: 25.2 g (0.06 lbs) Wall-mount bracket: 45 g (0.1 lbs) |

Table 12: Basic parameters

3.2 Standards and Regulations

| Parameter | Description |
|---------------|---|
| Radio | EN 301 908-1, EN 301 908-2, EN 301 908-13, EN 301 908-25, EN 303 413, EN 300 328, EN 301 893 |
| EMC | EN 301 491-1, EN 301 489-17, EN 301 489-19, EN 301 489-52, EN 61000-6-2, EN 61000-6-3, EN 55032, EN 61000-4-2, EN 61000-4-3, EN 61000-4-4, EN 61000-4-5, EN 61000-4-6 |
| Safety | EN 62368-1 |
| Mechanical | EN 60529, EN 60068-2-27, EN 60068-2-64 |
| Climatic | EN 60068-2-1, EN 60068-2-2, EN 60068-2-14, EN 60068-2-78 |
| National | ICR-16xx-EU: CE, UKCA |
| Environmental | REACH, RoHS3 and WEEE compliant |

Table 13: Standards and regulations

3.3 Type Testing and Environmental Conditions

| Phenomena | Test | Description | Test levels |
|--|---------------|---|--|
| ESD | EN 61000-4-2 | Enclosure contact | ± 8 kV (crit. B) |
| RF field AM modulated | EN 61000-4-3 | Enclosure | 3 V/m (crit. A) (80 – 1000 MHz) |
| Fast transient | EN 61000-4-4 | Signal ports Power ports Ethernet ports | ± 0.5 kV (crit. A) |
| Surge | EN 61000-4-5 | Ethernet ports Power ports | ± 0.5 kV (crit. B), ± 1 kV (crit. B) open circuit |
| RF conducted | EN 61000-4-6 | All ports | 3 V/m (crit. A) (0.15 – 80 MHz) |
| Radiated emission | EN 55032 | Enclosure | Class B |
| Conducted emission | EN 55032 | Signal ports Power ports Ethernet ports | Class B Class B Class B |
| Dry heat | EN 60068-2-2 | Test Bb, storage +85 °C, operation +75 °C | |
| Cold | EN 60068-2-1 | Test Ab, storage -40 °C, operation -40 °C | |
| Damp heat | EN 60068-2-78 | 95 % rel. humidity (+40 °C) | |
| Dry heat, cyclic | EN 60068-2-30 | +55 °C / +25 °C, rel. humidity 95 %, 12 h - 12 h | |
| Dry heat | EN 60068-2-2 | Test Bb, storage +85 °C, operation +75 °C | |
| Thermal shock/ temp. variation | EN 60068-2-14 | Test Nb, -40 °C/+75 °C, 3h/3h, 2 cycles, 3 K/min | |
| Degrees of protection provided by enclosures | EN 60529 | IP30 | |
| Vibration, broadband random | EN 60068-2-64 | Spectrum A.3 cat 1, breakpoints A.6 cat 1 | |
| Shock | EN 60068-2-27 | 50 m/s ² , 11 ms, half sine, 10 in each dir. | |

Table 14: Type testing and environmental conditions

3.4 Parameters of Cellular Module for ICR-16xx-EU

| Parameter | Description |
|-----------------------|---|
| Antenna | <ul style="list-style-type: none"> • Connector type: SMA • Impedance: 50 Ω |
| LTE parameters | <ul style="list-style-type: none"> • LTE Cat.4, 3GPP Rel.11 • FDD bands: B1 (2100 MHz), B3 (1800 MHz), B7 (2600 MHz), B8 (900 MHz), B20 (800 MHz), B28A (700MHz) • TDD bands: B38 (2600 MHz), B40 (2300 MHz), B41 (2500 MHz) • Bit rates: up to 150 Mbps (DL), 50 Mbps (UL) |
| HSPA+/UMTS parameters | <ul style="list-style-type: none"> • Supported frequencies: B8 (900 MHz), B1 (2100 MHz) • Bit rates: up to 42 Mbps (DL) / 5.76 Mbps (UL) |
| EDGE/GPRS parameters | <ul style="list-style-type: none"> • Supported frequencies: B8 (900 MHz), B3 (1800 MHz) • Bit rates: up to 296 kbps (DL) / 236.8 kbps (UL) |

Table 15: Technical parameters of the cellular module

3.5 Parameters of Cellular Module for ICR-16xx-CN

| Parameter | Description |
|-----------------------|---|
| Antenna | <ul style="list-style-type: none"> • Connector type: SMA • Impedance: 50 Ω |
| LTE parameters | <ul style="list-style-type: none"> • LTE Cat.4, 3GPP Rel.11 • FDD bands: B1 (2100 MHz), B3 (1800 MHz), B5 (850 MHz), B8 (900 MHz) • TDD bands: LTE-TDD Bands: B34 (2000MHz), B38 (2600 MHz), B39 (1900MHz), B40 (2300 MHz), B41 (2500 MHz) • LTE-FDD transfer rate: 150 Mbps (DL), 50 Mbps (UL) • LTE-TDD transfer rate: 130 Mbps (DL), 30 Mbps (UL) |
| HSPA+/UMTS parameters | <ul style="list-style-type: none"> • WCDMA Bands: B1/B8 • WCDMA transfer rate: 384 kbps (DL/UL) • TD-SCDMA Bands: B34/B39 • TD-SCDMA transfer rate: 2.4 Mbps (DL), 2.2 Mbps (UL) |
| EVDO/CDMA Parameters | <ul style="list-style-type: none"> • CDMA800 • Transfer rate EVDO: 3.1 Mbps (DL), 1.8 Mbps (UL) |
| EDGE/GPRS parameters | <ul style="list-style-type: none"> • Supported frequencies: EGSM900/ DCS1800 • GPRS transfer rate: 107 kbps (DL), 85.6 kbps (UL) • EDGE transfer rate: 296 kbps (DL), 236.8 kbps (UL) |

Table 16: Technical parameters of the cellular module

3.6 Parameters of GNSS (for ICR-16xxG only)

| Parameter | Description |
|----------------------------------|--|
| GNSS Systems | GPS, Galileo, QZSS, GLONASS, and BDS |
| Antenna | Connector type: SMA Input impedance: 50 Ω Supports active or passive antenna |
| Features | Protocol: NEMA 0183 |
| Frequency | GPS: 1575.42 \pm 1.023 MHz Galileo: 1575.42 \pm 2.046 MHz QZSS: 1575.42 MHz GLONASS: 1597.5–1605.8 MHz BDS: 1561.098 \pm 2.046 MHz |
| Sensitivity (autonomous) | Acquisition: -146 dBm Reacquisition: -157 dBm Tracking: -157 dBm |
| Acquisition time (autonomous) | Cold start: 35.0 s Warm start: 26.0 s Hot start: 2.5 s |
| Accuracy | 2.5 m |

Table 17: Technical parameters of GNSS

3.7 Parameters of Wi-Fi (for ICR-16xxW only)

| Parameter | Description |
|----------------------------|--|
| Antenna Connectors | R-SMA - 50 Ω |
| Supports Wi-Fi bands | 2.400 – 2.4835 GHz 5.150 – 5.850 GHz |
| Standards | IEEE: 802.11b, 802.11b/g, 802.11b/g/n, 802.11a, 802.11an, 802.11ac |
| 2.4 GHz supported channels | 1, 2, 3, 4, 5, 6, 7, 8, 9, 10, 11, 12, 13 |
| 5 GHz supported channels | 36, 40, 44, 48, 149, 153, 157, 161, 165 |
| Type of Device | Access point (AP) Station (STA) |
| Security – Standards | WPA, WPA2, WPA3, 802.1X |
| Security – Encryption | WEP, TKIP, AES |
| AP maximum users | Access Point mode: up to 16 clients max |

Table 18: Technical parameters of Wi-Fi

3.8 Parameters of I/O Ports

Electrical characteristics of the digital input are in Table 19. Status of the digital input can be retrieved in the router's web interface (on the *General Status* page) or by the `status ports` and `io get` commands, see *Command Line Interface* application note.

| Logical ¹ | Status ² |
|----------------------|---------------------|
| 1 | Open |
| 0 | Short to ISO_GND |

Table 19: Electrical characteristics of digital input

The maximum digital output load is **500 mA** at **48 V**.

3.9 Parameters of Serial Interfaces

Supported parameters of the RS232 and RS485 interfaces, which can be configured on Web GUI in *Configuration* → *Expansion Port 1* resp. *Configuration* → *Expansion Port 2* menu items, are in Table 20.

| Parameter | Description |
|--------------|--|
| Baudrate | 300, 600, 1200, 2400, 4800, 9600, 19200, 38400, 57600, 115200. |
| Data Bits | 5, 6, 7, 8. |
| Parity | none, even, odd. |
| Stop Bits | 1, 2. |
| Flow Control | none, CTS/RTS |

Table 20: Parameters of serial interfaces

3.10 System Configuration

The main parameters of the system are listed in Table 21.

| Parameter | Description |
|------------------|---|
| CPU architecture | ARM Cortex-A7 |
| CPU frequency | 1.2 GHz |
| CPU power | 1.9 DMIPS/MHz |
| Flash memory | 512 MB of NAND <ul style="list-style-type: none"> • ≈ 65 MB for Router Apps • ≈ 26 MB for customer data |
| RAM size | total: 256 MB; available: ≈ 160 MB |
| Watchdog | Yes |

Table 21: System configuration

¹The digital status returned by the `io get` shell command.

²The digital status returned by the `status ports` shell command and displayed on the *General Status* page.

Appendix A: Troubleshooting

Warning

If you cannot connect to the router from your PC, your network card may be configured in a way that prevents a connection. Try one or more of the following steps to resolve the issue:

- Ensure your PC's network card is configured to obtain an IP address automatically from a DHCP server (the router's DHCP server is enabled by default).
- Connect the router to the PC via a network switch.
- Connect the PC directly to the router, but start the router first and wait for it to initialize completely before starting the PC.

Ethernet Connection Fails or Is Unstable

- On the router's *Configuration* → *LAN* page, you can disable auto-negotiation and manually set a specific link speed and duplex mode. This can resolve compatibility issues with some network devices.

Mobile WAN Connection Fails or Is Intermittent

- Check the signal strength on the *Status* → *Mobile WAN* page. If the signal is weak, a more powerful antenna is required. If neighboring cells have similar signal strength, a directional antenna may be necessary to lock onto the optimal cell tower.
- Enable the connection check feature on the *Configuration* → *Mobile WAN* page in the *Check connection* section. Select the *Enable + bind* option. This will send periodic pings to check connectivity and restart the connection if it fails. The "bind" option ensures the ping is always sent through the Mobile WAN interface.

Cannot Establish Mobile WAN Connection

- Verify all settings on the *Configuration* → *Mobile WAN* page, including the *APN*, *username*, *password*, and *IP address*. For many public networks, these fields can be left blank.
- Check if the SIM card requires a PIN. If so, enter it on the *Administration* → *Unlock SIM Card* page.
- For private APN networks, it is often not recommended to obtain DNS server addresses from the operator. Disable this option on the *Configuration* → *Mobile WAN* page.
- Check the *Status* → *System Log* for error messages that can help diagnose the issue.

Cannot Connect to a Device Behind the Router from the Internet (NAT)

- The device behind the router must be configured to use the router's IP address as its default gateway.

Cannot Access a Web Server Behind the Router via NAT

- Remote HTTP access to the router itself must be disabled. This can be done on the *Configuration* → *NAT* page.
- On the same page, enable the *Send all remaining incoming packets to default server* feature and enter the IP address of your web server.
- Ensure the web server's default gateway is set to the router's IP address.

DynDNS Does Not Work

- DynDNS will not work with a private APN if the router's IP address is not publicly accessible.
- If your DynDNS hostname resolves to the same private IP address that is assigned to the router, it means your mobile operator is using NAT or a firewall, preventing direct connections.

- You can verify operator NAT by pinging a server with a static public IP and comparing the source IP (seen by the server) with the IP address shown on the router's status page.
- You can test for a firewall by trying to access the router's web interface remotely.
- The operator may not be providing DNS server addresses. Without DNS, the router cannot resolve the DynDNS service hostname. The System Log would show errors like:
 - Error resolving hostname: no such file or directory
 - Connect to DynDNS server failed

L2TP or IPsec Tunnel Fails to Establish

- Check the *Status* → *System Log* for specific error messages related to the VPN tunnel negotiation.

IPsec Tunnel Establishes, but No Data Is Transferred

- This is typically caused by incorrect routing rules or a misconfigured default gateway on either the client device or the remote network.

Router Reverts to Online Mode After a Reboot, Despite Being Set to Offline via SMS

- State changes made via SMS commands are temporary and do not alter the saved configuration. They remain in effect only until the router is rebooted.

Serial Communication Is Not Working

- Verify that your router model is equipped with a serial port. Check the serial communication settings on the *Configuration* → *Expansion Port* page.

Is the Router Cisco Compatible?

- No. The router's operating system (ICR-OS) is based on Linux, not Cisco IOS. Therefore, Cisco configuration commands cannot be used.
- However, since all network connections are based on open standards, the router is fully compatible and can be connected to Cisco devices or any other standard networking equipment.

FTP or SFTP Does Not Work

- **FTP** is available on v2 platform routers only. Ensure it is enabled in *Configuration* → *Services* → *FTP*. Connect using any FTP client to port **21** with the same username and password as the web interface.
- **SFTP** (SSH File Transfer Protocol) is available on all routers. Ensure SSH is enabled in *Configuration* → *Services* → *SSH*. Connect using any SFTP-capable client (like FileZilla or WinSCP) to port **22** with the same credentials as the web interface.

How to Access the Router's Command Line

- You can connect to the router's command line using SSH (all routers) or Telnet (v2 routers only).
- **SSH** is enabled by default. You can verify this in *Configuration* → *Services* → *SSH*. Use any SSH client to connect to the router's IP address on port **22**.
- **Telnet** can be enabled on v2 routers in *Configuration* → *Services* → *Telnet*.
- For both methods, use the same username and password as for the web interface.

Appendix B: Customer Support

Customer Support for Europe

Advantech Czech s.r.o.

Sokolska 71
562 04, Usti nad Orlici
Czech Republic

Phone: +353 91 792444
Fax: +353 91 792445
E-mail: iiotcustomerservice@advantech.eu
Web: www.advantech.com

Customer Support for NAM

Advantech North America

707 Dayton Road
Ottawa, IL 61350 USA

Phone: +1-800-346-3119 (Monday – Friday, 7 a.m. to 5:30 p.m. CST)
Fax: +1-815-433-5109
E-mail: support.iiot.ana@advantech.com
Web: www.advantech.com

Customer Support for Asia

Phone: +886-2-2792-7818 #1299 (Monday – Friday, 9 a.m. to 5:30 p.m. UTC+8)
Fax: +886-2-2794-7327
E-mail: icg.support@advantech.com.tw
Web: www.advantech.com

Appendix C: Regulatory & Safety Information

Safety Notices

For your safety and proper operation of the device, please observe the following instructions:

- The router must comply with all applicable international, national, and local regulations, including any specific restrictions concerning its use in designated applications and environments.
- To avoid personal injury or damage to the device, use only accessories that are approved or supplied by the manufacturer. Unauthorized modifications or the use of non-approved accessories may damage the router, violate regulations, and void the warranty.
- Do not attempt to open the router enclosure under any circumstances.
- Before handling the SIM card, always switch off the router and disconnect it from the power supply. Handle the SIM card with care to avoid damage or electrostatic discharge.

Important



This equipment is not suitable for use by or near young children. Small children could accidentally swallow the SIM card.

- Always ensure that the power supply voltage does not exceed 48 V DC.
- Do not expose the router to harsh environmental conditions. Protect it from dust, moisture, and excessive temperatures.
- Use only routers with proper certifications and markings in areas containing flammable or explosive materials (such as gas stations, chemical plants, or locations with explosives). In these environments, always follow the applicable restrictions regarding the use of radio devices.
- When traveling by airplane, always switch off the router. Using the router on board may endanger flight safety, interfere with mobile networks, and violate local regulations. Non-compliance can result in suspension or cancellation of telecommunications services or legal penalties.
- Take special care when operating the router in close proximity to personal medical devices such as cardiac pacemakers or hearing aids. If in doubt, consult the manufacturer of the medical device or your physician.
- This device may cause interference if used near television sets, radio receivers, or personal computers.
- Maintain a minimum separation distance of at least 20 cm between the router and the human body during operation.
- It is strongly recommended to regularly back up all critical configuration data stored in the router's memory.
- **Specific Usage Restrictions for 5 GHz Wi-Fi:** This device operates in the 5150–5350 MHz frequency band, which is restricted to **indoor use only** within the European Union, EFTA countries, and Northern Ireland. Outdoor use in this frequency band is prohibited to prevent harmful interference with other radio services.

| | | | | | | | | | | | |
|--|----|----|----|----|----|----|----|----|----|----|----|
| | AT | BE | BG | CY | CZ | DE | DK | EE | EL | ES | FI |
| | FR | HR | HU | IE | IT | LT | LU | LV | MT | NL | PL |
| | PT | RO | SE | SI | SK | IS | LI | NO | CH | TR | UK |

Product Disposal Instructions

The WEEE directive (Waste Electrical and Electronic Equipment: 2012/19/EU) ensures the environmentally responsible recycling and recovery of electronic products. This device contains high-quality materials and components suitable for recycling. At the end of its life, **do not dispose of this product with ordinary commercial waste**. The router also contains a battery. Remove the battery before disposing of the device, and ensure the battery is disposed of separately and in accordance with local regulations. For detailed information on product and battery disposal, consult your supplier's terms and conditions.

Appendix D: Related Documents

[1] [ICR-1600 Configuration Manual](#)

[EP] Product-related documents and applications can be obtained on **Engineering Portal** at <https://icr.advantech.com/support/router-models> address.



We, Advantech Czech s.r.o., declare that the radio equipment narrated in this user's manual complies with Directive **2014/53/EU**.



We, Advantech Czech s.r.o., declare that the radio equipment narrated in this user's manual complies with Radio Equipment Regulations 2017 (**S.I. 2017 No. 1206**).

The full text of the EU Declaration of Conformity is available at the following internet address:
icr.advantech.com/doc