

## Hardware Manual

### LTE Industrial Connectivity Gateway ICR-1602



© 2024 Advantech Czech s.r.o. No part of this publication may be reproduced or transmitted in any form or by any means, electronic or mechanical, including photography, recording, or any information storage and retrieval system without written consent. Information in this manual is subject to change without notice, and it does not represent a commitment on the part of Advantech.

Advantech Czech s.r.o. shall not be liable for incidental or consequential damages resulting from the furnishing, performance, or use of this manual.

All brand names used in this manual are the registered trademarks of their respective owners. The use of trademarks or other designations in this publication is for reference purposes only and does not constitute an endorsement by the trademark holder.

# Used symbols



Danger – Information regarding user safety or potential damage to the router.



Attention – Problems that can arise in specific situations.



Information – Useful tips or information of special interest.



# Contents

<b>1. Product Overview</b>	<b>1</b>
1.1 Product Introduction	1
1.2 Usage Examples	2
1.3 Hardware Overview	6
1.4 Order Codes	7
1.5 Package Contents	8
1.6 Product Dimensions	9
1.7 Mounting Recommendations	12
1.8 Wall Mounting	13
1.9 DIN Rail Mounting	14
1.10 Product Label	15
<b>2. Hardware Functionality</b>	<b>16</b>
2.1 SIM Card Slots	16
2.2 Antennas Interfaces	17
2.3 Ethernet Interfaces	17
2.4 Power Supply	18
2.5 LED Status Indication	19
2.6 Reset Functions	20
<b>3. First Use</b>	<b>21</b>
3.1 Accessories Connection	21
3.2 Router Configuration	21
<b>4. Technical Parameters</b>	<b>22</b>
4.1 Basic Parameters	22
4.2 Standards and Regulations	23
4.3 Type Tests and Environmental Conditions	24
4.4 Parameters of Cellular Module for ICR-16xx-EU	25
4.5 Parameters of Cellular Module for ICR-16xx-CN	26
4.6 Parameters of GNSS (for ICR-16xxG only)	27
4.7 Parameters of WiFi (for ICR-16xxW only)	28
4.8 System Configuration	29
<b>Appendix A: Troubleshooting</b>	<b>30</b>
<b>Appendix B: Customer Support</b>	<b>33</b>
<b>Appendix C: Regulatory &amp; Safety Information</b>	<b>34</b>
<b>Appendix D: Related Documents</b>	<b>35</b>

# List of Figures

1	Cellular Internet Access . . . . .	2
2	Backup for Internet Access . . . . .	3
3	VPN Networks Interconnection . . . . .	4
4	Serial Gateway . . . . .	5
5	Router Hardware Overview: Front View . . . . .	6
6	Router Hardware Overview: Rear View . . . . .	7
7	Router Dimensions – Front, Top and Right view for basic set . . . . .	9
8	Router Dimensions – Front, Top and Right view with Wall Mounting holder . . . . .	10
9	Router Dimensions – Front, Top and Right view with DIN holder . . . . .	11
10	Wall Mounting Clip . . . . .	13
11	Default Position of the DIN Rail Clip . . . . .	14
12	Product Label . . . . .	15
13	SIM Cards Insertion . . . . .	16
14	Ethernet Connector Pinout of RJ45 Socket . . . . .	17
15	Power Connector Pinout . . . . .	18
16	Position of the Grounding Screw . . . . .	18
17	Resetting the Router . . . . .	20

# List of Tables

1	Router Hardware Overview: Front View . . . . .	6
2	Router Hardware Overview: Rear View . . . . .	7
3	Order Codes Overview . . . . .	7
4	Contents of Package . . . . .	8
5	Ethernet Connector Pinout Description of RJ45 Socket . . . . .	17
6	Power connector pinout . . . . .	18
7	LED Status Indication . . . . .	19
8	LED Status Indication . . . . .	19
9	Basic Parameters . . . . .	22
10	Standards and Regulations . . . . .	23
11	Type Tests and Environmental Conditions . . . . .	24
12	Technical Parameters of Cellular Module . . . . .	25
13	Technical Parameters of Cellular Module . . . . .	26
14	Technical Parameters of GNSS . . . . .	27
15	Technical Parameters of WiFi . . . . .	28
16	System Configuration . . . . .	29

# 1. Product Overview

## 1.1 Product Introduction

Industrial connectivity gateway ICR-1602 series is designed for wireless communication to enable connection of IP devices and serial buses to a cellular network.

Industrial M2M and IoT applications include kiosks, industrial PCs, HMIs, traffic controllers, meters, UPS systems, and much more.

The peak **downlink** data rate for **LTE** Cat.4 is approximately **150 Mbps**. Also in the **uplink**, **LTE** Cat.4 provides a peak data rate of **50 Mbps**.

The router is equipped with two Gigabit Ethernet ports. The gateway supports **VPN** tunnel creation using various protocols to ensure safe communications. The gateway provides diagnostic functions which include automatic monitoring of the wireless and wired connections, automatic restart in case of connection losses, and a hardware watchdog that monitors the router status.

The connectivity gateway is based on ICR-OS operation system. Open Linux platform enable wide possibilities of programming customer SW applications in **Python**, **C/C++**. Router supports uploading of certain **Router Apps** (basic features only), that would extend standard firmware functionalities. Existing app library ready for free download by customer contains already developed software apps to enhance specific router functionality.

Compatibility with Advantech's **remote device management** platforms, [WebAccess/DMP](#) and [WebAccess/VPN](#), offers extensive device management and monitoring, ensuring that devices remain up-to-date and secure.

## 1.2 Usage Examples

### Cellular Internet Access

- This example demonstrates a common scenario where the cellular router facilitates access from a local LAN to the Internet via the cellular network.
- This functionality is not available on LAN routers lacking a cellular interface.

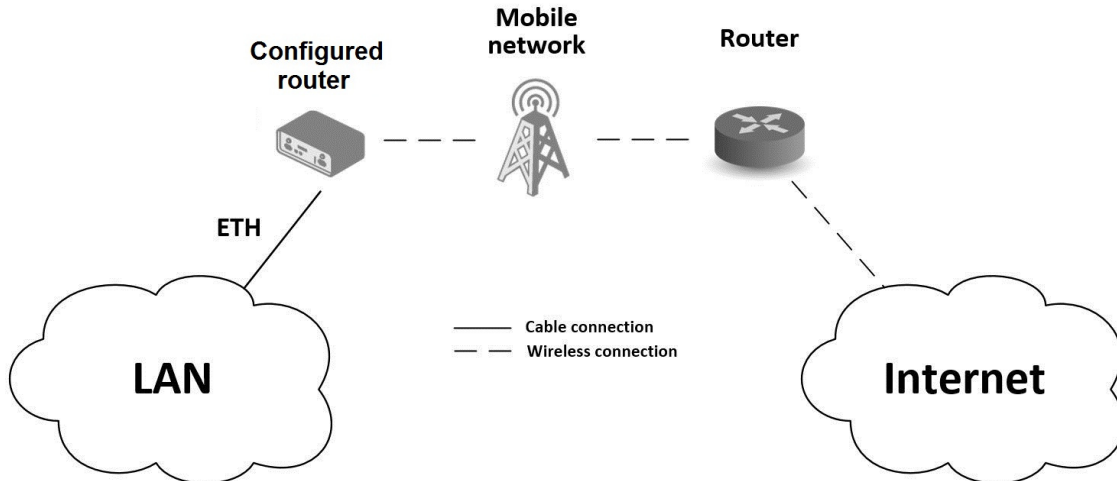

Figure 1: Cellular Internet Access



### Backup for Internet Access

- This example showcases how a cellular router's Internet access can be backed up.
- Backup options include PPPoE connections, Ethernet wired connections or WiFi.

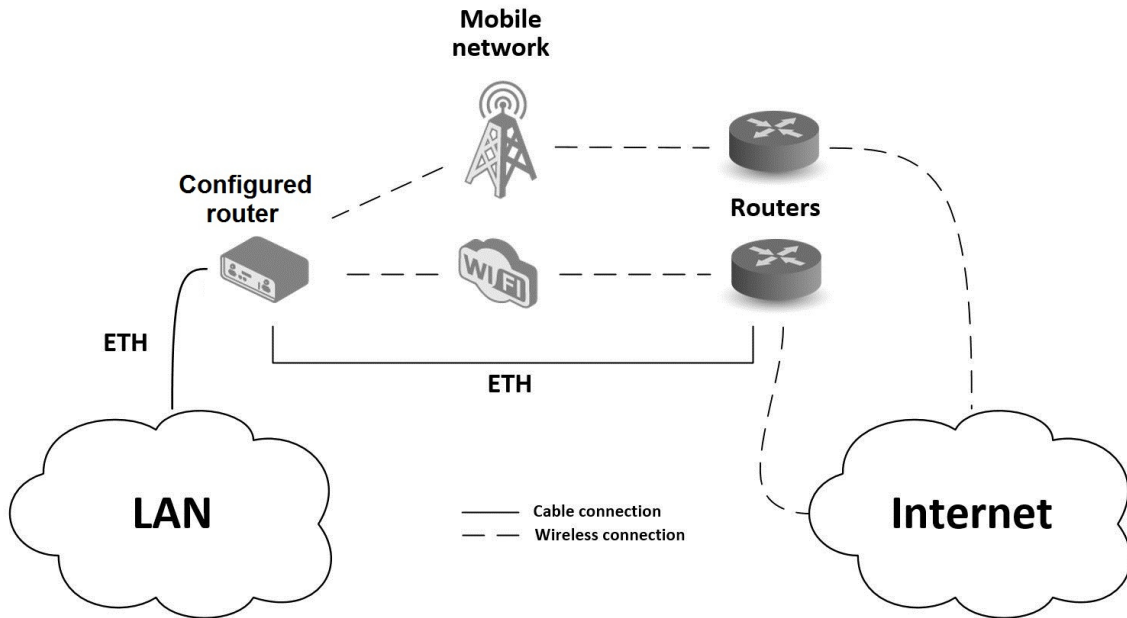

Figure 2: Backup for Internet Access

### VPN Networks Interconnection

- This example highlights the establishment of a secure VPN tunnel for interconnecting the configured Advantech router with a router in a remote network, facilitated via the Internet.
- The configured router connects to the Internet using the cellular network.

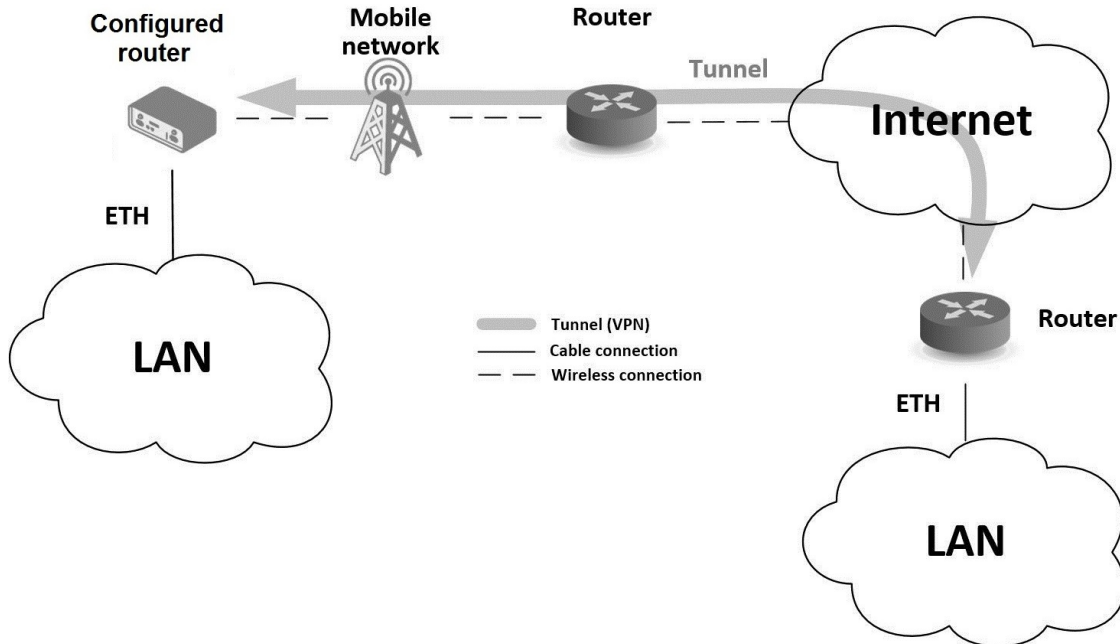

Figure 3: VPN Networks Interconnection

### Serial Gateway

- This example depicts a scenario where the configured Advantech router grants access to a PLC device interfaced serially with the router.
- The PLC device, accessible over the entire Internet network, can be controlled from a remote local network, such as one running a SCADA system.
- This functionality is exclusive to routers equipped with a serial interface.

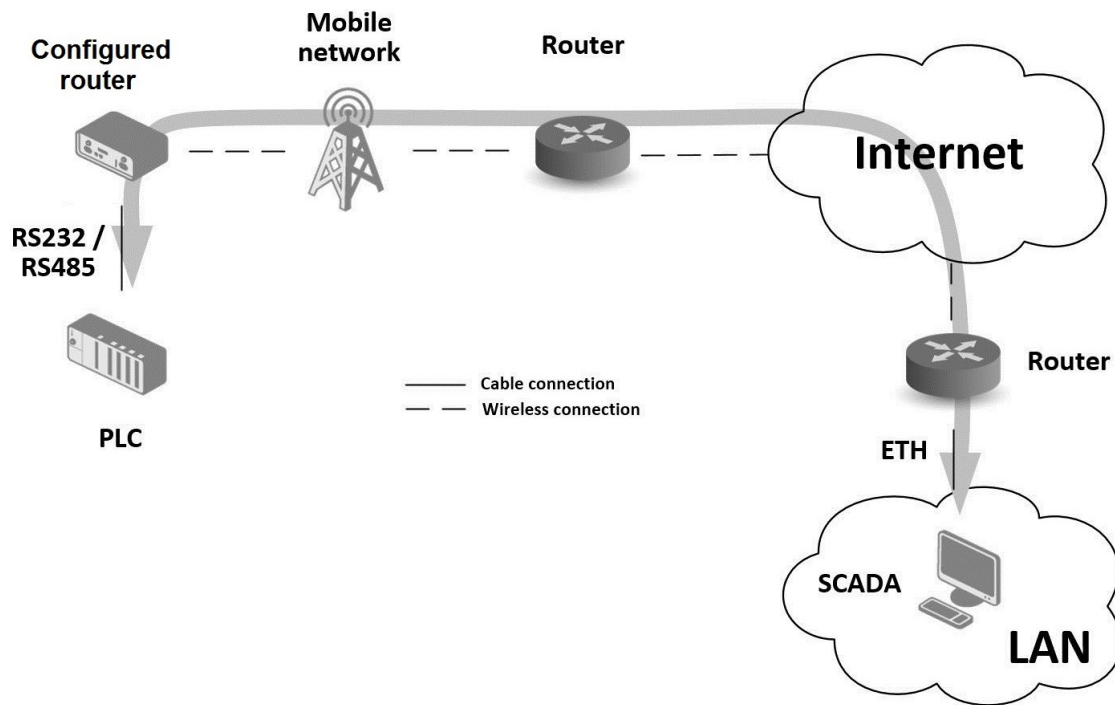

Figure 4: Serial Gateway

### 1.3 Hardware Overview

In this chapter, all components of the router case are described, including links to chapters that provide more details.



Figure 5: Router Hardware Overview: Front View

#	Item/Caption	Type	Description
1	RST	—	Button to reboot the router or restore default settings; see Chapter 2.6.
2	LEDs	—	Status LED indicators; see Chapter 2.5.
3	GND Screw	M3	Ensure proper grounding; refer to Chapter 2.4.
4	PWR	2-pin terminal	Power supply socket; see Chapter 2.4.
5	ETH0, ETH1	RJ45	1 Gb Ethernet LAN interfaces; see Chapter 2.3.
6	Wall Clip	—	Wall mounting clip, included as standard accessories; see Chapter 1.8.

Table 1: Router Hardware Overview: Front View



Figure 6: Router Hardware Overview: Rear View

#	Item/Caption	Type	Description
7	DIN Clip	—	DIN mounting clip, not included as standard accessories, can be ordered optionally; see Chapter 1.9.
8	SIM Slots	Micro SIM	Two Micro SIM card slots; details in Chapter 2.1.
9	ANT, DIV	—	Connectors for both the main and diversity antennas of the cellular module. Refer to Chapter 2.2 for details, Chapter 4.4 & 4.5 for cellular module parameters.

Table 2: Router Hardware Overview: Rear View

## 1.4 Order Codes

Order codes overview is shown in the table below.

Order code	Configuration
ICR-1602-EU-A	LTE Connectivity Gateway with 2 x Gigabit Ethernet port for <b>EMEA</b> , certified with CE/UKCA.
ICR-1602-CN-A	LTE Connectivity Gateway with 2 x Gigabit Ethernet port for <b>China</b> .

Table 3: Order Codes Overview

## 1.5 Package Contents

The standard set of the router includes the following items, as listed in the table below:





Item#	Description	Figure	Q'ty
1	Router		1 pc
2	Wall Mount Kit (packed in accessory box, including 4 screws of type M3 x 5L)		1 pc
3	2-pin terminal block for power supply (installed on the router)		1 pc
4	LTE Antennas (packed in accessory box)		2 pc
5	WiFi Antenna (packed in accessory box, WiFi model only)		1 pc
6	Printed <i>Quick Start Guide Leaflet</i>		1 pc

Table 4: Contents of Package

## 1.6 Product Dimensions

For the dimensions of the router see the figures below. Note that all sizes are measured in millimeters.

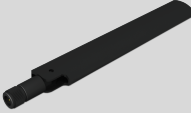
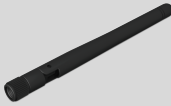
### Basic Set

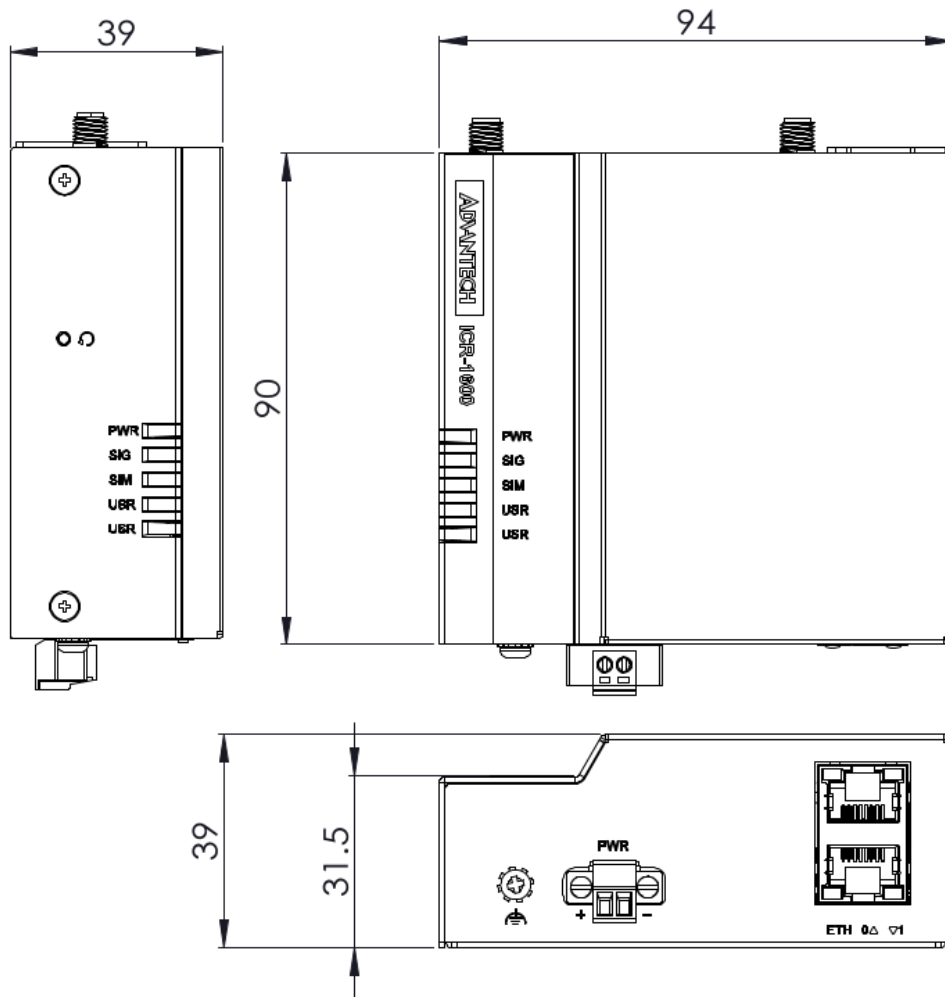

Figure 7: Router Dimensions – Front, Top and Right view for basic set

**Variant with Wall Mounting Clip**

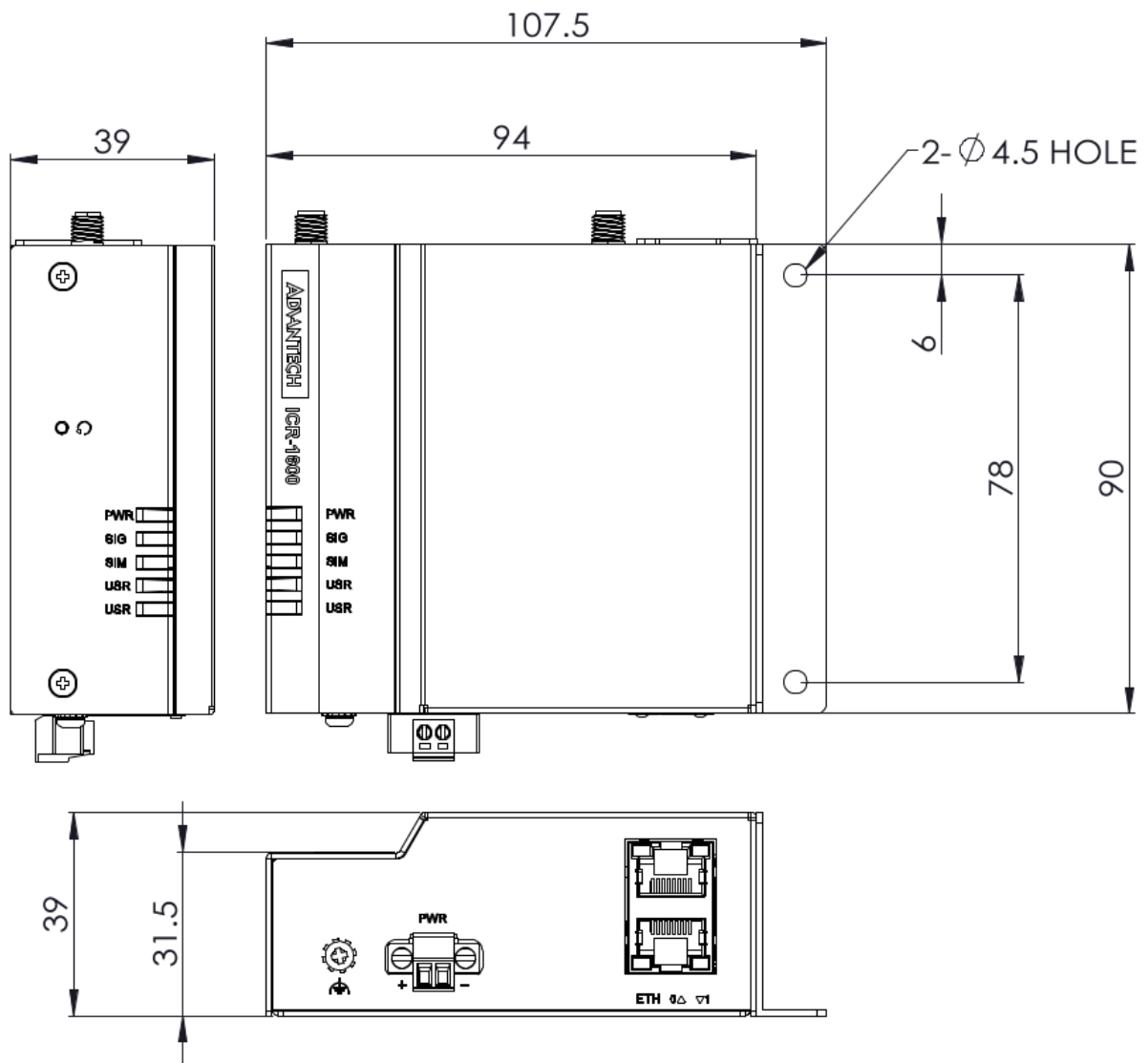

Figure 8: Router Dimensions – Front, Top and Right view with Wall Mounting holder



Variant with DIN Rail Clip

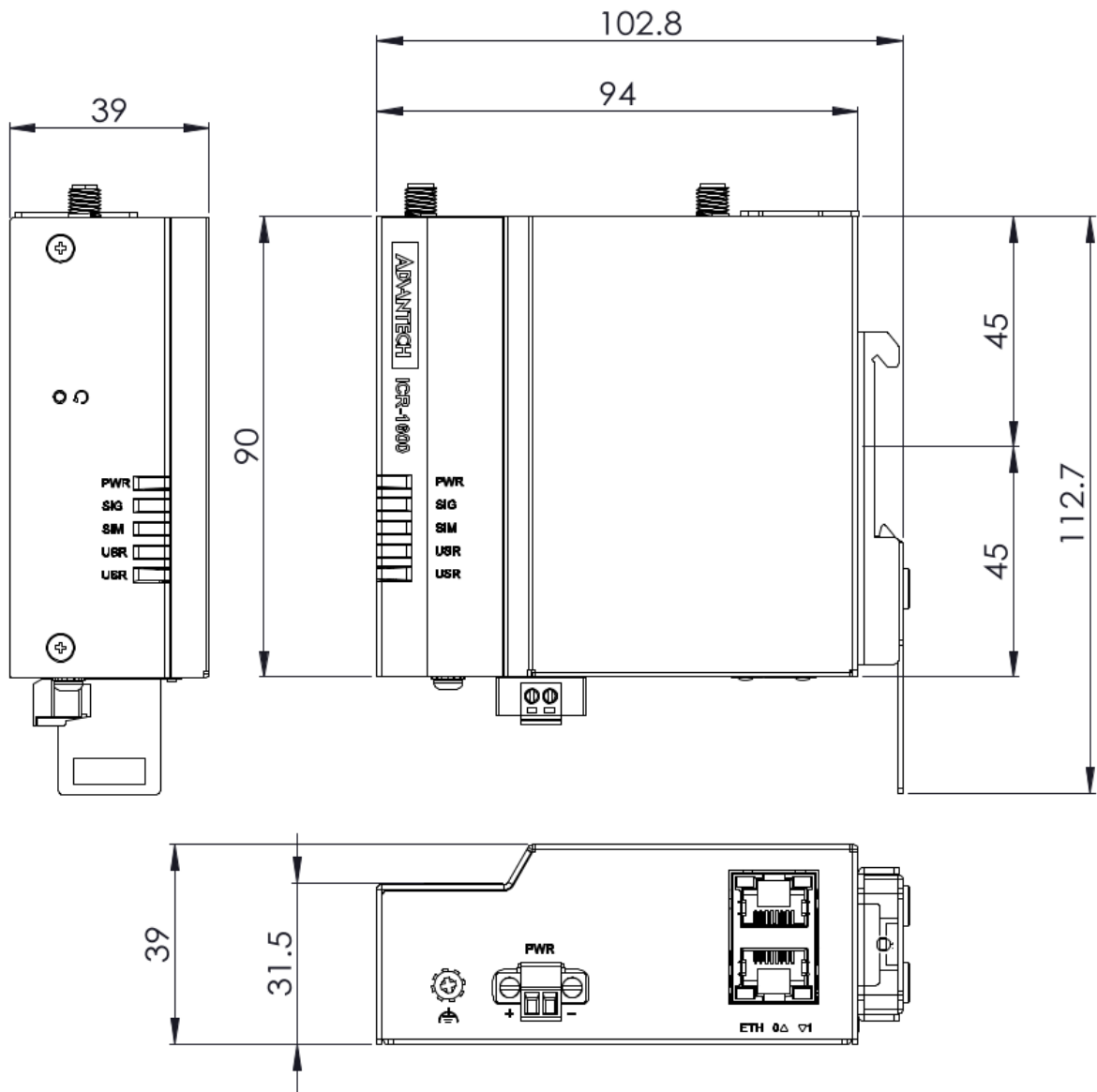

Figure 9: Router Dimensions – Front, Top and Right view with DIN holder

## 1.7 Mounting Recommendations

The router can be placed in the following ways:

- On a flat surface.
- On a wall using the wall mounting clip (refer to Chapter 1.8).
- On a DIN rail EN 60715 with the metal DIN rail clip (refer to Chapter 1.9).

For most applications involving a built-in router within a switchboard, two types of environments are typically encountered:

- A non-public industrial environment with low voltage but high interference.
- A public environment with low voltage and without high interference.

For both of these environments, it's feasible to mount the router to a switchboard, eliminating the need for immunity examination or EMC-related issues as per EN 61439-1:2011 standards.



To comply with the EN 61439-1:2011 specification, follow these assembly instructions when attaching a router to a switchboard:

- When using whip antennas, maintain a minimum distance of 6 cm from cables and metal surfaces on all sides to avoid interference. If an external antenna is used apart from the switchboard, a lightning conductor is necessary.
- When mounting a router on sheet steel, consider using a cable antenna.

For all cables, it's recommended to bundle them, following these guidelines:

- The combined length of the cable bundle (power supply and data cables) should not exceed 1.5 m. If data cable length surpasses 1.5 m or if the cable runs toward the switchboard, installing surge protectors is advisable.
- Data cables must not be bundled with mains voltage cables (230 V/50 Hz or 120 V/60 Hz).
- Ensure sufficient space is left between each connector for cable handling.
- For proper router functionality, use an earth-bonding distribution frame to ground the grounding screw (refer to Chapter 2.4).

## 1.8 Wall Mounting



The wall mounting clip is included as a standard accessory (packed in the accessory box, including 4 screws of type M3 x 5L).

The router can be affixed to a wall or another surface using the wall mounting clip. The delivered wall mounting clip can be assembled to the router as shown in Figure 10.

The wall mounting clip features two holes with a diameter of 4.5 millimeters for screw placement. For precise mounting dimensions, refer to Figure 8 in Chapter 1.6.



When attaching the wall mounting clip, tighten the screws with a maximum torque of 0.6 Nm (6 kg.cm).



Figure 10: Wall Mounting Clip

## 1.9 DIN Rail Mounting



The DIN rail mounting clip is not included as a standard accessory; it can be ordered separately under P/N OPT1-DIN-ICR1X-00.

You can attach the DIN rail clip to the router for mounting it onto a DIN rail that complies with the 60715 standards. The default position of the clip is depicted in Figure 11. If necessary, the clip can also be rotated into all four positions.



When attaching the clip, use 4 screws of type M3 x 5L, and tighten the screws with a maximum torque of 0.6 Nm (6 kg.cm).

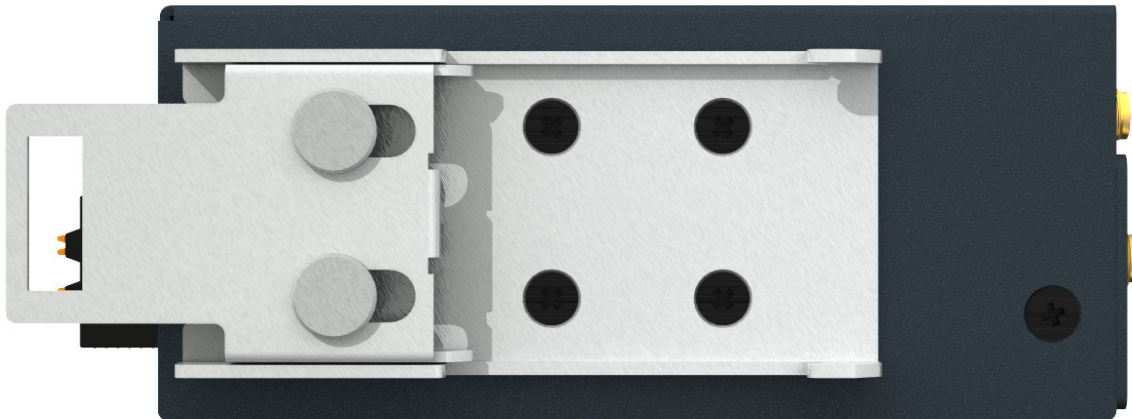

Figure 11: Default Position of the DIN Rail Clip

### 1.10 Product Label

The figure below shows an example of the product labels with all the information printed on them.



Figure 12: Product Label

## 2. Hardware Functionality

See Chapter 1.3 for an overview of the product's hardware, along with links to chapters offering detailed explanations.

### 2.1 SIM Card Slots

Slots for two SIM cards are located on the router beneath a metal cover. If you plan to use this device for cellular network communication, insert an activated data-provisioned SIM card into the SIM card slot.

You have the option to install two SIM cards simultaneously for utilizing the switching feature. The SIM cards can have different Access Point Names (APNs) configured. The procedure for changing SIM cards is outlined below. If the SIM requires a PIN, input it in the router's web interface (*Administration* → *Unlock SIM Card*).

 Type of SIM card: Micro SIM (3FF) 15.0 × 12.0 × 0.76 mm.

#### Inserting the SIM card:

- Always disconnect the router from the power supply before handling the SIM card.
- Unscrew the two screws on the SIM card cover and remove the cover.
- To remove an inserted SIM card, use the flat end of a spudger or your fingernail to press the SIM card slightly into its slot until you hear a click. Upon hearing the click, release the card, and it will pop out of its slot.
- To insert a SIM card, push the card into the slot until it clicks into place.
- Put the cover back and secure it with the two screws.

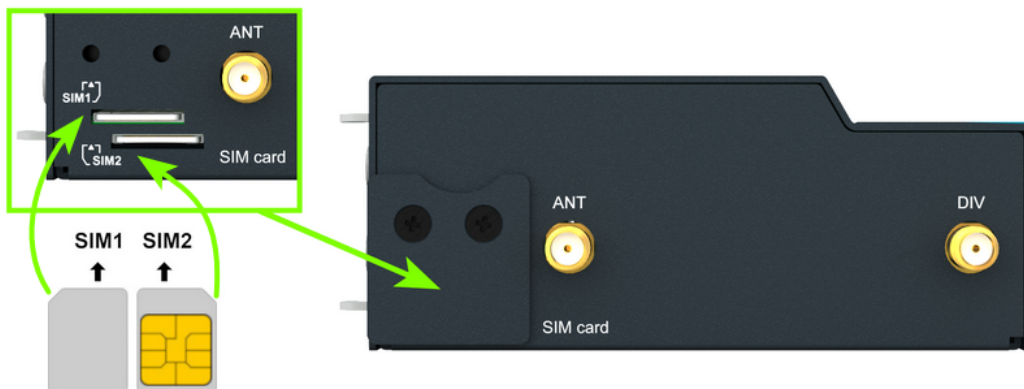

Figure 13: SIM Cards Insertion

## 2.2 Antennas Interfaces

The ANT and DIV SMA female connectors are designed for connecting the main and diversity cellular antennas to the router. Additionally, RP-SMA female connectors labeled AUX are provided for connecting WiFi or GNSS antennas on models that support WiFi or GNSS.



Do not run the router without connected cellular antennas as the energy from the transmission is effectively reflected by the open end and can damage the equipment.



Recommended tightening moment for screwing the antenna to the SMA connector is 0.9 Nm.

## 2.3 Ethernet Interfaces

The RJ45 panel socket is used for one ETH0 and one ETH1 Ethernet interfaces. The pinout of the socket is shown in Figure 14 and described in Table 5.

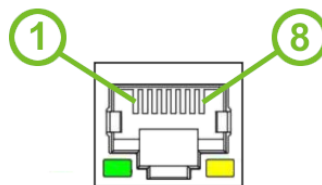

Figure 14: Ethernet Connector Pinout of RJ45 Socket

Pin	10base-T & 100base-T	1000base-T
1	Tx+ (Transmit Data+)	BI_DA+ (BiDirectional pair A+)
2	Tx- (Transmit Data-)	BI_DA- (BiDirectional pair A-)
3	Rx+ (Receive Data+)	BI_DB+ (BiDirectional pair B+)
4	—	BI_DC+ (BiDirectional pair C+)
5	—	BI_DC- (BiDirectional pair C-)
6	Rx- (Receive Data-)	BI_DB- (BiDirectional pair B-)
7	—	BI_DD+ (BiDirectional pair D+)
8	—	BI_DD- (BiDirectional pair D-)

Table 5: Ethernet Connector Pinout Description of RJ45 Socket



The isolation barrier of the Ethernet ports against the ground is 1500 V.

## 2.4 Power Supply

A two-pin terminal connector (pitch 3.5 mm) is utilized to power the router. The corresponding connector is included as a standard accessory with the router.

Pin	Signal mark	Description
1	VCC(+)	Positive pole of DC supply voltage (+9 to +48 V DC)
2	GND(-)	Negative pole of DC supply voltage

Table 6: Power connector pinout

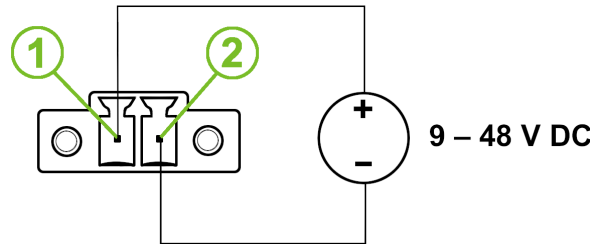

Figure 15: Power Connector Pinout

The required power supply voltage for the router ranges between +9 V and +48 V DC. Refer to the connection scheme in Figure 15 for proper setup. The router is equipped with built-in protection against reversed polarity, functioning without signaling. To guarantee correct operation, the power source must be capable of providing a sufficient amount of energy, as detailed in the consumption section of Chapter 4.1.



Grounding the router using the grounding screw eliminates the protection against reversed polarity. Ensure the negative pole of the DC power supply shares the same voltage reference as the grounding screw. A voltage difference between these points may damage the router, necessitating repairs exclusively by an authorized service center.



Unit has to be supplied by a power supply specified as a Limited Power Source (LPS) or CEC/NEC Class 2 source of supply.

All metal parts, including the box, are interconnected with the negative pole of the power supply (common pole). If recommended for the installation environment, protect the router by properly grounding it using the grounding screw, as depicted in Figure 16. The maximum tightening torque for the grounding screw is 0.6 Nm (6 kg.cm).

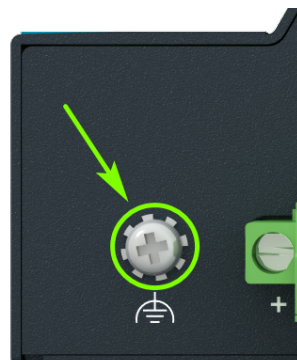

Figure 16: Position of the Grounding Screw



## 2.5 LED Status Indication

There are status LEDs on the top side of the router to provide router status information. Moreover, ETH0 and ETH1 connectors, located on the front panel, have two additional LEDs providing information about the port status.







	Caption	Color	State	Description
	PWR	Green Green Off	On Blinking Off	Powered up, the system is booting up. System is ready and operating normally. No power.
	SIG	Green Orange Red Off	On / blinking On / blinking On / blinking Off	Good cellular signal. Fair cellular signal. Poor cellular signal. No cellular link.
	SIM	Green Orange Green Orange Red Off	Blinking Blinking On On Fast blinking Off	SIM 1 is selected, waits for data connection. SIM 2 is selected, waits for data connection. Connects through SIM 1. Connects through SIM 2. Missing SIM card or PIN code problem. No SIM card is selected.
	USR	Green	—	The function of this LED is user-defined.
	ETH0 ETH1	Green Green	On Off	Selected 1 Gbps bit rate. Selected 100/10 Mbps bit rate.
	ETH0 ETH1	Yellow Yellow Yellow	On Brief off blinks Off	The network cable is connected. Data transmission. The network cable is not connected.

Table 7: LED Status Indication

The following describes when *USR* is defined as Serial or WiFi:



	Caption	Color	State	Description
	Serial/USR	Green Off	Blinking Off	Serial Port 1 TX/RX transmitting data. No RS232/RS485 data.
	WiFi/USR	Green Green Off	On Blinking Off	AP or STA mode is selected. Transmitting data. No AP or STA mode is selected.

Table 8: LED Status Indication

## 2.6 Reset Functions

The RST button has multiple functions depending on the firmware platform. For more information, see the configuration manual [1], chapter *Manual Introduction* → *Device* → *Reset*.

-  Use a narrow screwdriver or any small tool to press the *RST* button.



Figure 17: Resetting the Router

# 3. First Use

## 3.1 Accessories Connection

Before putting the router into operation, make sure to connect all the components required for running your applications. Refer to Chapter 1.3 for an overview of the hardware. Also, remember to insert a SIM card for the cellular connection as explained in Chapter 2.1.



Ensure you do not operate the router without an antenna connected to the main antenna connector. Transmitting energy is effectively reflected by the open end, which could potentially damage the equipment.

## 3.2 Router Configuration

You can perform the initial configuration of the router using a web browser on your PC. This interface allows for router monitoring, configuration, and administration.

Begin by connecting the power supply to the router (refer to Chapter 2.4). The router will initiate its boot process. By default, the router will automatically establish a connection to the default Access Point Name (APN) of the inserted SIM card. Ensure your PC is configured to obtain IP settings automatically from the network. Connect your PC's network card to the default LAN interface of the router, Ethernet port ETH0. The DHCP server will assign an IP address to your PC.

To access the router's web interface, enter the following address in your web browser: <https://192.168.1.1>. Please note that using the HTTPS protocol for secure communication over the network is mandatory. The default user is `root`. Check the **product label** on the router for the **default password**. The user will be prompted to **change their password** when logging into the new router for the **first time**.



Consult the router **Configuration Manual** [1] for detailed descriptions and examples of router configuration.



For security reasons, we recommend regularly updating the router's firmware to the latest version. Downgrading the firmware to an older version than the production version or uploading firmware intended for a different device may cause the device to malfunction.

# 4. Technical Parameters

## 4.1 Basic Parameters

Parameter		Description
Temperature range	Operating	-40 °C to +75 °C (-40 °F to +167 °F)
	Storage	-40 °C to +85 °C (-40 °F to +185 °F)
Humidity	Operating	5 to 95 % relative humidity non condensing
	Storage	5 to 95 % relative humidity non condensing
Altitude	Operating	2000 m / 70 kPa
Degree of protection		IP30
Supply voltage		9 – 48 V DC
Consumption for non-WiFi / WiFi version	Idle	2.8 W / 3.8 W
	Average	3.5 W / 4.5 W
	Maximum	3.8 W / 5.5 W
Dimensions of device (w/o clips)		94 × 39 × 90 mm (3.7" × 1.53" × 3.54")
DIN rail clip specification		DIN 30 mm (DIN clip is an optional)
Weight		ICR-16XX: 331 g (0.73 lbs) (excluding below accessories) LTE Antenna: 25.2 g (0.06 lbs) Wall-mount bracket: 45 g (0.1 lbs)

Table 9: Basic Parameters

## 4.2 Standards and Regulations

Parameter	Description
Radio	EN 301 908-1, EN 301 908-2, EN 301 908-13, EN 301 908-25, EN 303 413, EN 300 328, EN 301 893
EMC	EN 301 491-1, EN 301 489-17, EN 301 489-19, EN 301 489-52, EN 61000-6-2, EN 61000-6-3, EN 55032, EN 61000-4-2, EN 61000-4-3, EN 61000-4-4, EN 61000-4-5, EN 61000-4-6
Safety	EN 62368-1
Mechanical	EN 60529, EN 60068-2-27, EN 60068-2-64
Climatic	EN 60068-2-1, EN 60068-2-2, EN 60068-2-14, EN 60068-2-78
National	CE, UKCA for ICR-16xx-EU SRRC, NAL for ICR-16xx-CN
Environmental	REACH, RoHS3 and WEEE compliant

Table 10: Standards and Regulations

### 4.3 Type Tests and Environmental Conditions

Phenomena	Test	Description	Test levels
ESD	EN 61000-4-2	Enclosure contact	± 6 kV (crit. A)
RF field AM modulated	EN 61000-4-3	Enclosure	20 V/m (crit. A) (80 – 1000 MHz) 10 V/m (crit. A) (1 – 6 GHz)
Fast transient	EN 61000-4-4	Signal ports Power ports Ethernet ports	± 1 kV (crit. A) ± 2 kV (crit. A) ± 1 kV (crit. A)
Surge	EN 61000-4-5	Ethernet ports Power ports	± 1 kV (crit. A), shielded cab. ± 1 kV (crit. A)
RF conducted	EN 61000-4-6	All ports	10 V/m (crit. A) (0.15 – 80 MHz)
Radiated emission	EN 55032	Enclosure	Class B
Conducted emission	EN 55032	Signal ports Power ports Ethernet ports	Class B Class B Class B
Dry heat	EN 60068-2-2	Test Bb, storage +85 °C, operation +75 °C	
Cold	EN 60068-2-1	Test Ab, storage -40 °C, operation -40 °C	
Damp heat	EN 60068-2-78	95 % rel. humidity (+40 °C)	
Dry heat, cyclic	EN 60068-2-30	+55 °C / +25 °C, rel. humidity 95 %, 12 h - 12 h	
Dry heat	EN 60068-2-2	Test Bb, storage +85 °C, operation +75 °C	
Thermal shock/ temp. variation	EN 60068-2-14	Test Nb, -40 °C/+75 °C, 3h/3h, 2 cycles, 3 K/min	
Degrees of protection provided by enclosures	EN 60529	IP30	
Vibration, broadband random	EN 60068-2-64	Spectrum A.3 cat 1, breakpoints A.6 cat 1	
Shock	EN 60068-2-27	50 m/s <sup>2</sup> , 11 ms, half sine, 10 in each dir.	

Table 11: Type Tests and Environmental Conditions

## 4.4 Parameters of Cellular Module for ICR-16xx-EU

Parameter	Description
Antenna	<ul style="list-style-type: none"> <li>• Connector type: SMA (ANT + DIV)</li> <li>• VSWR: <math>\leq 3</math></li> <li>• Efficiency: <math>&gt; 30\%</math></li> </ul>
LTE parameters	<ul style="list-style-type: none"> <li>• Support up to non-CA Cat.4 FDD and TDD</li> <li>• Supported modulations: QPSK (DL/UL), 16QAM and 64QAM</li> <li>• Supported FDD bands: B1 (2100), B3 (1800+), B5 (850), B7 (2600), B8 (900 GSM), B20 (800 DD)</li> <li>• Supported TDD bands: B38 (TD 2600), B40 (TD 2300), B41 (120M) (TD 2500+)</li> <li>• Bandwidth: 1.4 MHz to 20 MHz</li> <li>• Peak bit rates: 300 Mbps (DL), 50 Mbps (UL) @ <math>2 \times 2</math> MIMO</li> <li>• Power class: Class 3 (23 dBm <math>\pm</math> 2 dBm)</li> </ul>
WCDMA parameters	<ul style="list-style-type: none"> <li>• Support 3GPP R8/DC-HSDPA/HSPA+/HSDPA/HSUPA/WCDMA</li> <li>• Supported modulations: QPSK, 16QAM and 64QAM</li> <li>• Supported bands: B1 (2100 MHz), B5 (850 MHz), B8 (900 MHz)</li> <li>• Peak bit rates: 42 Mbps (DL), 5.76 Mbps (UL)</li> <li>• Power class: Class 3 (23.5 dBm <math>\pm</math> 2 dBm)</li> </ul>

Table 12: Technical Parameters of Cellular Module

## 4.5 Parameters of Cellular Module for ICR-16xx-CN

Parameter	Description
Antenna	<ul style="list-style-type: none"> <li>• Connector type: SMA (ANT + DIV)</li> <li>• VSWR: <math>\leq 3</math></li> <li>• Efficiency: <math>&gt; 30\%</math></li> </ul>
LTE parameters	<ul style="list-style-type: none"> <li>• Support up to non-CA Cat.4 FDD and TDD</li> <li>• Supported modulations: QPSK (DL/UL), 16QAM and 64QAM</li> <li>• Supported FDD bands: B1 (2100), B3 (1800+), B5 (850), B8 (900 GSM)</li> <li>• Supported TDD bands: B34 (TD 2100), B38 (TD 2600), B39 (TD 1900), B40 (TD 2300), B41 (120M) (TD 2500+)</li> <li>• Bandwidth: 1.4 MHz to 20 MHz</li> <li>• Peak bit rates: 300 Mbps (DL), 50 Mbps (UL) @ <math>2 \times 2</math> MIMO</li> <li>• Power class: Class 3 (23 dBm <math>\pm</math> 2 dBm)</li> </ul>
WCDMA parameters	<ul style="list-style-type: none"> <li>• Support 3GPP R8/DC-HSDPA/HSPA+/HSDPA/HSUPA/WCDMA</li> <li>• Supported modulations: QPSK, 16QAM and 64QAM</li> <li>• Supported bands: B1 (2100 MHz), B8 (900 MHz)</li> <li>• Peak bit rates: 42 Mbps (DL), 5.76 Mbps (UL)</li> <li>• Power class: Class 3 (23.5 dBm <math>\pm</math> 2 dBm)</li> </ul>

Table 13: Technical Parameters of Cellular Module



## 4.6 Parameters of GNSS (for ICR-16xxG only)

Parameter	Description
GNSS Systems	GPS, Galileo, QZSS, GLONASS, and BDS
Antenna	Connector type: SMA Input impedance: 50 $\Omega$ Supports active or passive antenna
Features	Protocol: NEMA 0183
Frequency	GPS: 1575.42 $\pm$ 1.023 MHz Galileo: 1575.42 $\pm$ 2.046 MHz QZSS: 1575.42 MHz GLONASS: 1597.5–1605.8 MHz BDS: 1561.098 $\pm$ 2.046 MHz
Sensitivity (autonomous)	Acquisition: -146 dBm Reacquisition: -157 dBm Tracking: -157 dBm
Acquisition time (autonomous)	Cold start: 35.0 s Warm start: 26.0 s Hot start: 2.5 s
Accuracy	2.5 m

Table 14: Technical Parameters of GNSS

## 4.7 Parameters of WiFi (for ICR-16xxW only)

Parameter	Description
Antenna Connectors	R-SMA - 50 $\Omega$
Supports WiFi bands	2.400 – 2.4835 GHz 5.150 – 5.850 GHz
Standards	IEEE: 802.11b, 802.11b/g, 802.11b/g/n, 802.11a, 802.11an, 802.11ac
2.4 GHz supported channels	1, 2, 3, 4, 5, 6, 7, 8, 9, 10, 11, 12, 13
5 GHz supported channels	36, 40, 44, 48, 149, 153, 157, 161, 165
Type of Device	Access point (AP) Station (STA)
Security – Standards	WPA, WPA2, WPA3, 802.1X
Security – Encryption	WEP, TKIP, AES
AP maximum users	Access Point mode: up to 16 clients max

Table 15: Technical Parameters of WiFi

## 4.8 System Configuration

The main parameters of the system are listed in Table 16.

Parameter	Description
CPU architecture	ARM Cortex-A7
CPU frequency	1.2 GHz
CPU power	1.9 DMIPS/MHz
Flash memory	512 MB of eMMC <ul style="list-style-type: none"><li>• <math>\approx</math> 60.5 MB for Router Apps</li><li>• <math>\approx</math> 26.7 MB for customer data</li></ul>
RAM size	256 MB
Watchdog	Yes

Table 16: System Configuration

# Appendix A: Troubleshooting

If you cannot connect to the router from your PC, your network card may be configured in such a way that it is not possible to connect to the router. Take one or more of the following steps in order to solve the problem:

- Make sure your PC's network card is configured to obtain the IP address from the DHCP server (by default the DHCP server is running in the router).
- Connect the router to the PC via Switch.
- Connect the router to the PC, start the router first and then start the PC after the router's initialization.

## Ethernet connection fails or is not establishing.

- It is possible to turn auto negotiation off and set a rate and duplex manually on the Ethernet interface of the router. Available on "LAN Configuration" page in the router.

## Mobile WAN connection fails.

- Check the signal power ("Mobile WAN status" page). If the signal power is weak, you will have to use a better antenna. If the neighbouring cells have a similar signal strength, you will need to use a directional antenna. For proper operation, the signal levels have to be good.
- Try to enable automatic ping from the router, which will check the connection when there are no data running and in the case of a failed ping, restart the connection. This can be done on the "Mobile WAN Configuration" page in the router in the "Check connection" section. "Enable + bind" option is to ensure the ping goes always through Mobile WAN network interface.

## Mobile WAN connection cannot be established.

- Check the "Mobile WAN Configuration" – APN, name, password and IP address (all can be blank).
- Try to enter the SIM card PIN – verify that the SIM card has the PIN code entered. Available on "Unlock SIM Card" page in the "Administration" section.
- In a private APN it is not recommended to get the DNS settings from operator (on "Mobile WAN" page)
- Go to "System Log" page in "Status" section and observe where the error occurs.

## I cannot connect from the Internet to the device behind the router. I have NAT enabled.

- The device's gateway has to be configured so it points to the router.

## I can't access my Web server placed behind the router over NAT.

- The remote HTTP access to the router has to be disabled on "NAT Configuration" page in the router. Also enable "Send all remaining incoming packets to default server" feature and fill in the IP address of your Web server. On the Web server, the default gateway has to be the IP address of the router.

## DynDNS doesn't work.

- With private APN this will not work.

- If the same IP address is recorded in your canonic name as a dynamically assigned address, it means that the operator is using NAT or a firewall.
- You can verify NAT using ping to your server with static address and then compare with router's IP address.
- You can verify a Firewall by accessing remotely to the router's Web interface.
- The operator may not provide the address of DNS server and without DNS server's address it is impossible to connect to the dyndns.org server. The following messages will be shown in the System Log:
  - DynDNS daemon started
  - Error resolving hostname: no such file or directory
  - Connect to DynDNS server failed

 **L2TP or IPSec isn't establishing.**

- Check the "System Log" page for error messages.

 **IPSec tunnel establishes but the communication does not run.**

- Probably there are bad routing rules defined in the connected devices, or the default gateway.

 **I switched the router to offline mode by SMS message, but the router is in online mode after reboot.**

- SMS messages do not change the router configuration. They remain in effect only until the router is rebooted.

### **Serial communication is not working.**

- Verify that the router model supports serial communications. Also verify the serial communication settings. To do so, open the router's configuration menu via the web browser, select the appropriate "Expansion Port" from "Configuration" part of the menu and verify the settings.

### **Is the router Cisco compatible? Can I use the Cisco configuration?**

- No, the Firmware in the router (ICR-OS) is based on Linux with BusyBox. Thus the Cisco configuration cannot be used. But network connections are defined by standards so connecting the router to the Cisco or other networking devices is possible and will be compatible.

### **FTP or SFTP does not work**

- FTP will work on v2 routers only. You can use SFTP on all routers to transfer files to/from the router. If having troubles with FTP on v2 routers, make sure you have FTP enabled: "Configuration" section, "Services", "FTP". Then you can connect with any client on port 21 with name and password same as for the Web interface. If having troubles with SFTP, make sure you have SSH enabled: "Configuration" section, "Services", "SSH". Then you can connect with any client on port 22 with name and password same as for the Web interface.

### **How can I connect to the router's command line? (SSH, Telnet)**

- You can use SSH on all routers or Telnet on v2 routers only. SSH is enabled by default, but you can verify in Web interface in "Configuration" section, "Services", "SSH". Then connect with any SSH client on port 22 of the router. User and password is the same as for the Web interface. Telnet on v2 routers can be enabled here: "Configuration" section, "Services", "Telnet".

# Appendix B: Customer Support

## Customer Support for Europe

### Advantech Czech s.r.o.

Sokolska 71  
562 04, Usti nad Orlici  
Czech Republic

Phone: +353 91 792444  
Fax: +353 91 792445  
E-mail: [iiotcustomerservice@advantech.eu](mailto:iiotcustomerservice@advantech.eu)  
Web: [www.advantech.com](http://www.advantech.com)

## Customer Support for NAM

### Advantech B+B SmartWorx

707 Dayton Road  
Ottawa, IL 61350 USA

Phone: +1-800-346-3119 (Monday – Friday, 7 a.m. to 5:30 p.m. CST)  
Fax: +1-815-433-5109  
E-mail: [support.iiot.ana@advantech.com](mailto:support.iiot.ana@advantech.com)  
Web: [www.advantech.com](http://www.advantech.com)

## Customer Support for Asia

Phone: +886-2-2792-7818 #1299 (Monday – Friday, 9 a.m. to 5:30 p.m. UTC+8)  
Fax: +886-2-2794-7327  
E-mail: [icg.support@advantech.com.tw](mailto:icg.support@advantech.com.tw)  
Web: [www.advantech.com](http://www.advantech.com)

# Appendix C: Regulatory & Safety Information

## Safety Notices



Please, observe the following instructions:

- The router must adhere to all relevant international and national laws, including any specific restrictions governing its use in designated applications and environments.
- To prevent potential injury and appliance damage, ensure compliance with regulations by using only authorized accessories. Unauthorized modifications or use of unapproved accessories could damage the router, violate regulations, and void the warranty.
- Do not attempt to open the router.
- Before handling the SIM card, turn off the router and disconnect it from the power supply.
- **Caution!** This equipment is not suitable for use in areas with children. Small children could swallow the SIM card.
- Ensure the power supply does not exceed 48 V DC maximum.
- Avoid exposing the router to extreme ambient conditions. Safeguard it against dust, moisture, and high temperatures.
- Only deploy routers with appropriate certification and labeling in environments containing flammable or explosive materials, such as gas stations, chemical plants, or areas involving explosives. Users must observe restrictions pertaining to radio device usage in such settings.
- When traveling by plane, switch off the router. Using it onboard could jeopardize flight operations, disrupt mobile networks, and potentially violate regulations. Non-compliance may result in telephone service suspension, cancellation, or legal repercussions.
- Exercise heightened caution when operating the router near personal medical devices like cardiac pacemakers or hearing aids.
- The router may cause interference when operated in close proximity to TV sets, radio receivers, or personal computers.
- It's advisable to create a suitable backup of all critical settings stored in the device's memory.



## Product Disposal Instructions

The WEEE (Waste Electrical and Electronic Equipment: 2012/19/EU) directive was introduced to ensure that electrical/electronic products are recycled using the best available recovery techniques to minimize the environmental impact. This product contains high quality materials and components which can be recycled. At the end of its life this product **MUST NOT** be mixed with other commercial waste for disposal. The device contains a battery. Remove the battery from the device before disposal. The battery in the device needs to be disposed of apart accordingly. Check the terms and conditions of your supplier for disposal information.



# Appendix D: Related Documents

[1] ICR-1600 Configuration Manual



[EP] Product-related documents and applications can be obtained on **Engineering Portal** at <https://icr.advantech.com/download> address.



We, Advantech Czech s.r.o., declare that the radio equipment narrated in this user's manual complies with Directive **2014/53/EU**.



We, Advantech Czech s.r.o., declare that the radio equipment narrated in this user's manual complies with Radio Equipment Regulations 2017 (**S.I. 2017 No. 1206**).

The full text of the EU Declaration of Conformity is available at the following internet address:  
[icr.advantech.com/eudoc](http://icr.advantech.com/eudoc)