

Hardware Manual

5G Industrial Router

ICR-4161



© 2025 Advantech Czech s.r.o. No part of this publication may be reproduced or transmitted in any form or by any means, electronic or mechanical, including photography, recording, or any information storage and retrieval system without written consent. Information in this manual is subject to change without notice, and it does not represent a commitment on the part of Advantech.

Advantech Czech s.r.o. shall not be liable for incidental or consequential damages resulting from the furnishing, performance, or use of this manual.

All brand names used in this manual are the registered trademarks of their respective owners. The use of trademarks or other designations in this publication is for reference purposes only and does not constitute an endorsement by the trademark holder.

Used symbols



Danger – Information regarding user safety or potential damage to the router.



Attention – Problems that can arise in specific situations.



Information – Useful tips or information of special interest.



Contents

1. Product Overview	1
1.1 Product Introduction	1
1.2 Hardware Overview	2
1.3 Order Codes	4
1.4 Product Revisions	4
1.5 Package Contents	5
1.6 Product Dimensions	6
1.7 Mounting Recommendations	8
1.8 Wall Mounting	9
1.9 DIN Rail Mounting	10
1.10 Product Label	11
1.11 First Use	12
2. Hardware Functionality	13
2.1 SIM Card Slots	13
2.2 Antennas Interfaces	14
2.3 Bluetooth	14
2.4 Ethernet Interfaces	15
2.5 Power Supply	16
2.6 Low Power Mode	17
2.7 USB 3.0 Port	18
2.8 MicroSD Card Reader	19
2.9 LED Status Indication	20
2.10 Reset Functions	21
3. Technical Parameters	22
3.1 Basic Parameters	22
3.2 Standards and Regulations	23
3.3 Type Tests and Environmental Conditions	24
3.4 Parameters of Cellular Module	25
3.4.1 Antenna Mapping	27
3.5 Parameters of GNSS	28
3.6 Parameters of WiFi	29
3.7 Parameters of Bluetooth	30
3.8 System Configuration	30
Appendix A: Troubleshooting	31
Appendix B: Customer Support	34
Appendix C: Regulatory & Safety Information	35
Appendix D: Related Documents	36

List of Figures

1	Router Hardware Overview – Front View	2
2	Router Hardware Overview – Rear View	3
3	Router Dimensions – Front, Top and Right view with Wall Mounting holder	6
4	Router Dimensions – Front, Top and Right view with DIN holder	7
5	Rotated Wall Mounting Clips	9
6	Default Position of the DIN Rail Clip	10
7	Removing Router from the DIN Rail	10
8	Product Label	11
9	SIM Cards Insertion	13
10	Ethernet Connector Pinout of RJ45 Socket	15
11	Power Connector Pinout	16
12	Position of the Grounding Screw	16
13	USB 3.0 Connector Pinout	18
14	MicroSD Card Insertion	19
15	Resetting the Router	21

List of Tables

1	Router Hardware Overview – Front View	2
2	Router Hardware Overview – Rear View	3
3	Order Codes Overview	4
4	HW Revisions History	4
5	Contents of Package	5
6	Ethernet Connector Pinout Description of RJ45 Socket	15
7	Power connector pinout	16
8	USB 3.0 Connector Pinout Description	18
9	Technical Specifications of MicroSD Card	19
10	LED Status Indication	20
11	Basic Parameters	22
12	Standards and Regulations	23
13	Type Tests and Environmental Conditions	24
14	Technical Parameters of Cellular Module	26
15	Cellular Module Antenna Mapping	27
16	Technical Parameters of GNSS	28
17	Technical Parameters of WiFi	29
18	Technical parameters of Bluetooth	30
19	System Configuration	30

1. Product Overview

1.1 Product Introduction

The ICR-4161 router series represents the pinnacle of industrial routers, leveraging the full capabilities of **5G technology**. Specifically designed for the EMEA market, these routers offer unparalleled data transfer speeds, minimal latency, and exceptional network reliability. The superior performance of these 5G routers provides significant advantages over their 4G/3G/2G predecessors, establishing them as the preferred solution for a broad spectrum of industrial applications.

Perhaps the most notable benefit of the 5G and the ICR-4161 router series is the dramatically reduced latency. This decrease in data transmission delay ensures real-time responsiveness, making these routers particularly suitable for applications necessitating immediate feedback or interaction. Industries benefit from smooth and instant communication, irrespective of geographic location, enabling precise and accurate monitoring and control of critical processes.

Featuring ultra-high-speed data transfer rates of up to **3.4 Gbps for downloads** and **900 Mbps for uploads**, this router is perfectly suited for demanding IoT applications in various industries, including industrial routers and gateways, digital signage, and industrial PCs and tablets.

Enhanced cellular network performance is achieved with **4x4 MIMO** technology, supplemented by support for dual **GNSS** antennas through shared SMA connectors with cellular antennas. WiFi-equipped models offer **dual-band WiFi 6/6E** capability, featuring **2x2 MU-MIMO** antennas, along with **Bluetooth V5.2** support.

Housed within a robust metal enclosure, the router is equipped with two **SIM card slots** to ensure cellular connection redundancy. It also boasts two **1Gb Ethernet ports**, a **USB 3.0** socket. Additionally, a **microSD card** slot is available to expand storage capabilities.

The router features a **Low Power Mode** and a **hardware watchdog** for automated status monitoring and system restarts, supplemented by additional diagnostic functionalities to bolster overall reliability.

Router configuration is accessible through a **secure web interface**, offering detailed insights into the entire configuration, statuses, signal strength, and logs.

Basic features include **two-factor authentication**, **IPv6 Dual Stack**, **DHCP**, **NAT**, **NAT-T**, **DynDNS**, **DNS proxy**, **VLAN**, **QoS**, **NTP**, **VRRP**, **SMS control**, **port forwarding**, and **connection backup**, among others. The router supports various VPN protocols, including **IPSec**, **OpenVPN**, **GRE**, **L2TP**, and **PPTP**, ensuring secure communication.

The router allows for the insertion of **Linux scripts** for automated tasks. It supports the definition of up to **four distinct profiles**, switchable via the web interface or SMS.

Router Apps enhance router functionality through custom software programs. For Advantech routers, a diverse array of Router Apps is offered, encompassing categories such as connectivity, routing, services, among others, freely accessible on the Advantech [Router Apps](#) webpage. Additionally, directly from the router web interface, you can use an **Advantech public server** for the Router App or router firmware installation/update.

Compatibility with Advantech's **remote device management** platform, [WebAccess/DMP](#), offers extensive device management and monitoring, ensuring that devices remain up-to-date and secure.

1.2 Hardware Overview

In this chapter, all components of the router case are described, including links to chapters that provide more details.



Figure 1: Router Hardware Overview – Front View

#	Item/Caption	Type	Description
1	GND Screw	M3	Ensure proper grounding; refer to Chapter 2.5.
2	LEDs	—	Status LED indicators; see Chapter 2.9.
3	RST	—	Button to reboot the router or restore default settings; see Chapter 2.10.
4	PWR	2-pin terminal	Power supply socket; see Chapter 2.5.
5	ETH0, ETH1	RJ45	1 Gb Ethernet LAN interfaces; see Chapter 2.4.
6	USB	USB-A	USB 3.0 host port; see Chapter 2.7.
7	ANT0, ANT1, ANT2, ANT3	SMA female	Cellular module antenna connectors. ANT1 and ANT3 are shared with GNSS. Refer to Chapter 2.2 for details, Chapter 3.4 for cellular module parameters, and Chapter 3.5 for GNSS parameters.
8	WIFI	RP-SMA female	Connectors for the WiFi antennas. See Chapter 2.2 for more information and Chapter 3.6 for WiFi parameters. The WiFi connector located on the right-hand side can be used for a Bluetooth antenna; see Chapter 2.3 for more information and Chapter 3.7 for Bluetooth parameters.

Table 1: Router Hardware Overview – Front View



Figure 2: Router Hardware Overview – Rear View

#	Item/Caption	Type	Description
9	Wall Clips	—	Wall mounting clips, included as standard accessories; see Chapter 1.8.
10	SIM Slots microSD Slot	Mini SIM microSD	Two Mini SIM card slots; details in Chapter 2.1. MicroSD card slot; see Chapter 2.8.
11	DIN Clip	—	DIN mounting clips, included as standard accessories; see Chapter 1.9.

Table 2: Router Hardware Overview – Rear View

1.3 Order Codes

Order codes overview is shown in the table below.

Order code	Configuration
ICR-4161	5G NR / LTE (DL Cat 19 / UL Cat 18) cellular module, two Gb ETH, GNSS, USB 3.0, microSD card slot, two SIM readers
ICR-4161W	5G NR / LTE (DL Cat 19 / UL Cat 18) cellular module, two Gb ETH, GNSS, dual-band WiFi 6/6E , USB 3.0, microSD card slot, two SIM readers

Table 3: Order Codes Overview

1.4 Product Revisions

For the product revision history of the entire product platform, refer to the table below. Please note that some revisions may not be available for certain order codes. The revision number is printed on both the packaging and product labels.

The router GUI can also display the product revision under *Status* → *General* → *System Information* → *Product Revision*. Please note that the default revision (Rev. 1.0) may not be available here.

Rev.#	Description
1.0	Initial version (revision number not printed on the labels).
1.1	On the chassis: 7 SMA holes instead of 6; refer to PCN-2024-05 for details.

Table 4: HW Revisions History

1.5 Package Contents

The standard set of the router includes the following items, as listed in the table below:



Item#	Description	Figure	Q'ty
1	Router (includes wall clips and a DIN rail clip mounted on the router)		1 pc
2	2-pin terminal block for power supply (installed on the router)		1 pc
3	Printed <i>Quick Start Guide Leaflet</i>		1 pc

Table 5: Contents of Package

1.6 Product Dimensions

For the dimensions of the router see the figures below. Note that all sizes are measured in millimeters.

Variant with Wall Mounting Clip

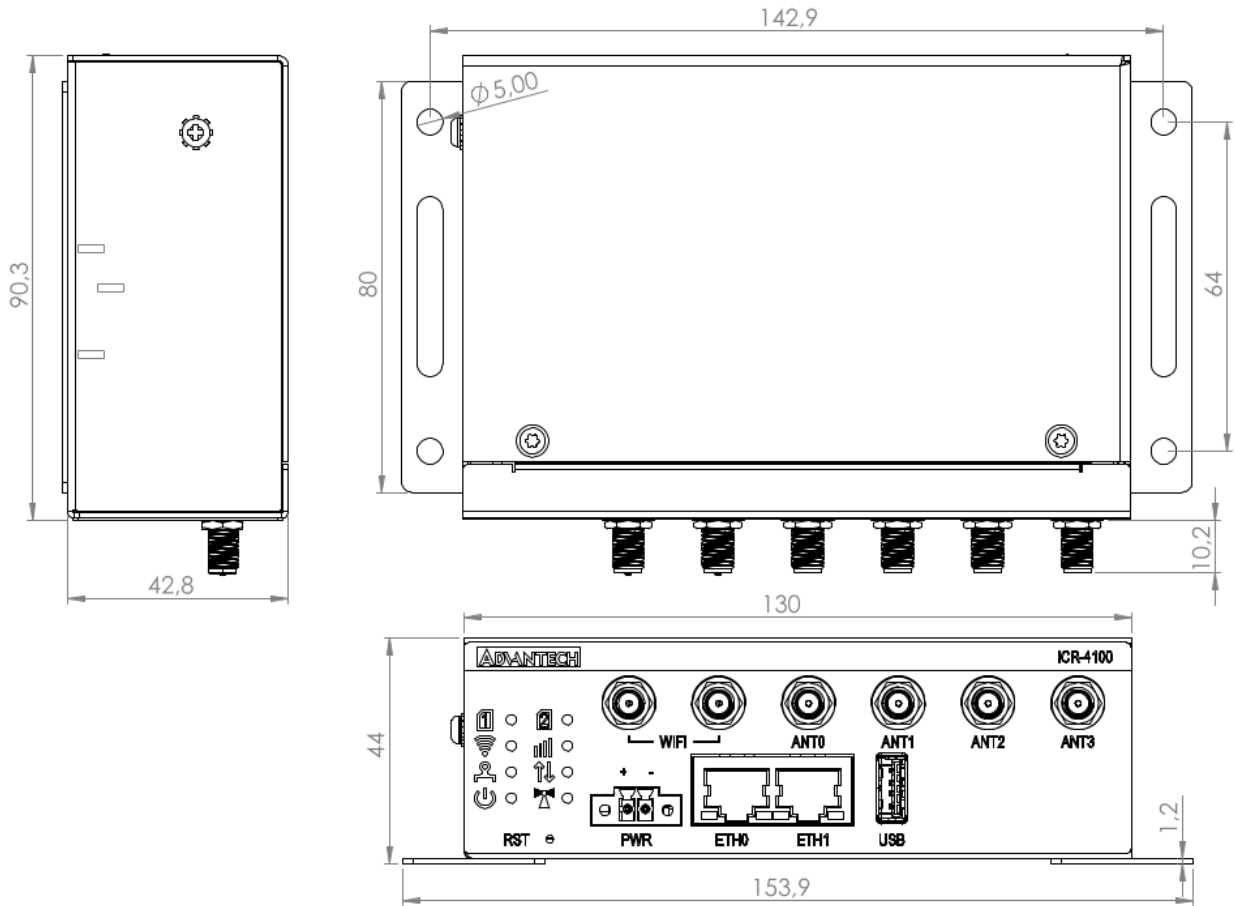

Figure 3: Router Dimensions – Front, Top and Right view with Wall Mounting holder

Variant with DIN Rail Clip

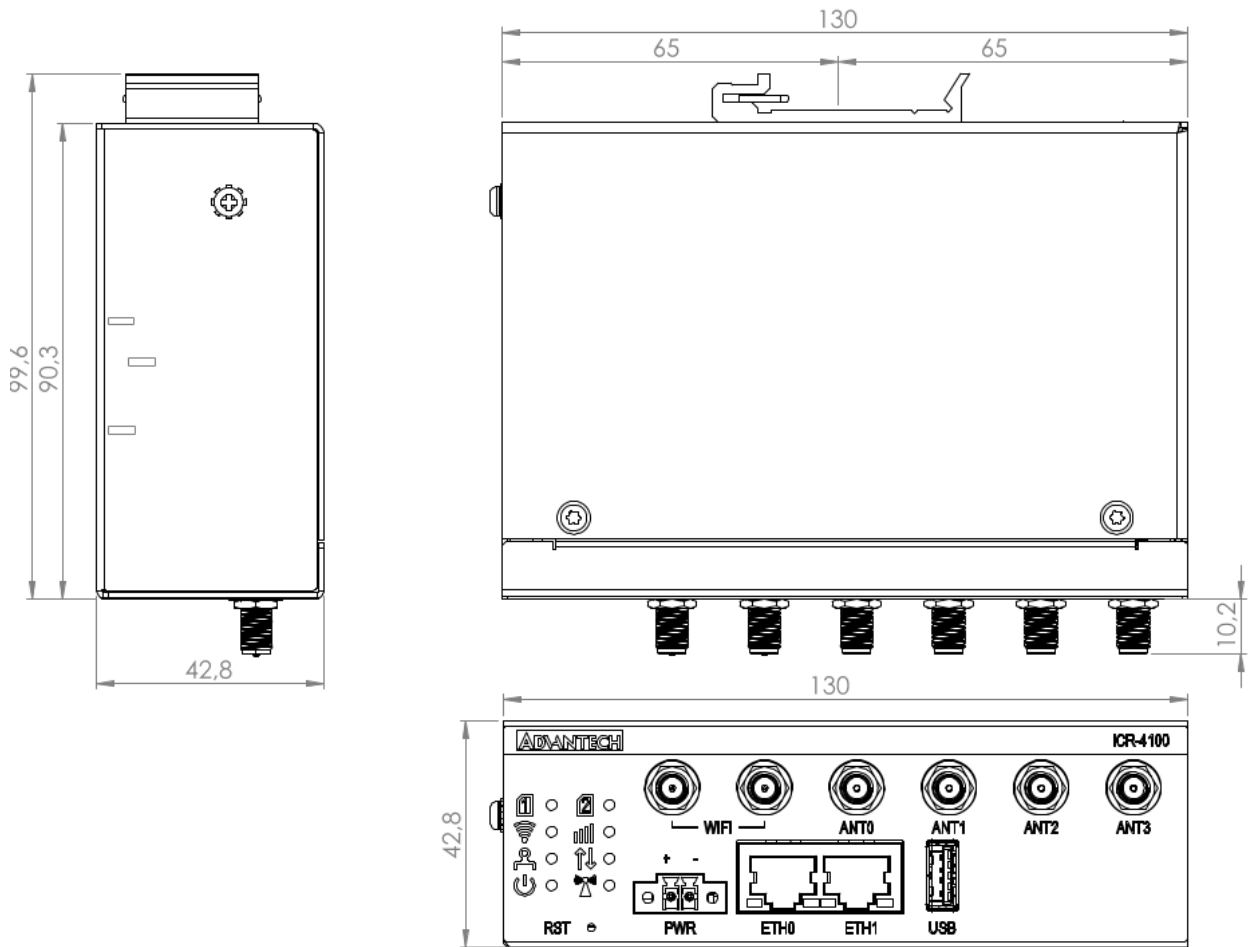

Figure 4: Router Dimensions – Front, Top and Right view with DIN holder

1.7 Mounting Recommendations

The router can be placed in the following ways:

- On a flat surface.
- On a wall using the wall mounting clips (refer to Chapter 1.8).
- On a DIN rail EN 60715 with the metal DIN rail clip (refer to Chapter 1.9).

For most applications involving a built-in router within a switchboard, two types of environments are typically encountered:

- A non-public industrial environment with low voltage but high interference.
- A public environment with low voltage and without high interference.

For both of these environments, it's feasible to mount the router to a switchboard, eliminating the need for immunity examination or EMC-related issues as per EN 61439-1:2011 standards.



To comply with the EN 61439-1:2011 specification, follow these assembly instructions when attaching a router to a switchboard:

- When using whip antennas, maintain a minimum distance of 6 cm from cables and metal surfaces on all sides to avoid interference. If an external antenna is used apart from the switchboard, a lightning conductor is necessary.
- When mounting a router on sheet steel, consider using a cable antenna.

For all cables, it's recommended to bundle them, following these guidelines:

- The combined length of the cable bundle (power supply and data cables) should not exceed 1.5 m. If data cable length surpasses 1.5 m or if the cable runs toward the switchboard, installing surge protectors is advisable.
- Data cables must not be bundled with mains voltage cables (230 V/50 Hz or 120 V/60 Hz).
- Ensure sufficient space is left between each connector for cable handling.
- For proper router functionality, use an earth-bonding distribution frame to ground the grounding screw (refer to Chapter 2.5).

1.8 Wall Mounting

i The wall mounting clips are included as a standard accessory with the router.

The router can be affixed to a wall or another surface using the wall mounting clips. Two wall mounting clips are pre-assembled to the router during production and need to be rotated as shown in Figure 5.

Each clip features two holes with a diameter of 5 millimeters for screw placement. For precise mounting dimensions, refer to Figure 3 in Chapter 1.6.

! When attaching the wall mounting clips, tighten the screws with a maximum torque of 0.4 Nm.

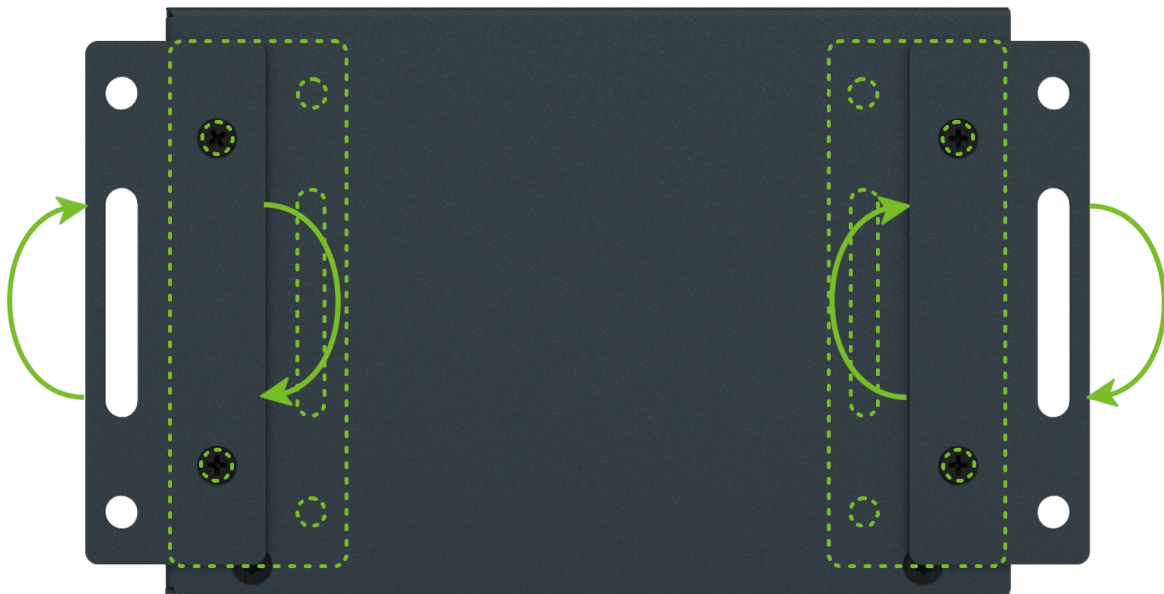

Figure 5: Rotated Wall Mounting Clips

1.9 DIN Rail Mounting

You can attach the DIN rail clip to the router for mounting it onto a DIN rail that complies with the 60715 standards. The default position of the clip is depicted in Figure 6. If necessary, the clip can also be rotated vertically.

! When attaching the clip, tighten the screws with a maximum torque of 0.4 Nm.

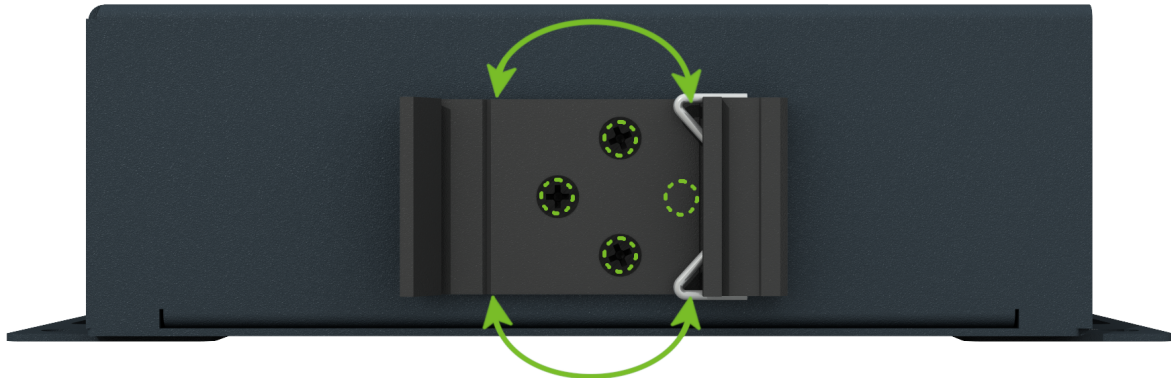

Figure 6: Default Position of the DIN Rail Clip

To remove the router from the DIN rail, lightly push down on the router to disengage the bottom part of the DIN rail clip from the rail. Then, pivot the bottom part of the router away from the DIN rail, as demonstrated in Figure 7.

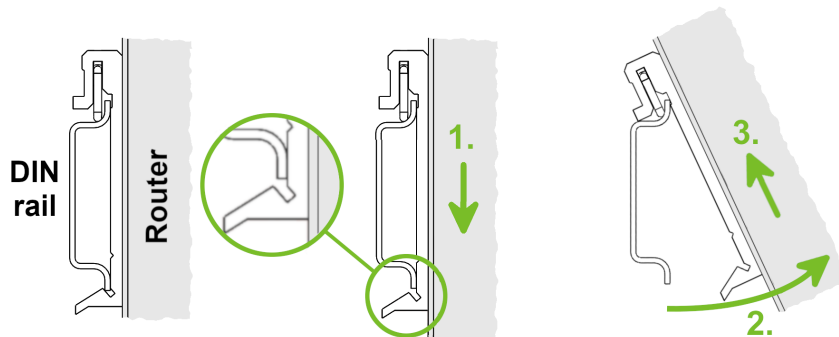

Figure 7: Removing Router from the DIN Rail

1.10 Product Label

The figure below shows an example of the product labels with all the information printed on them.

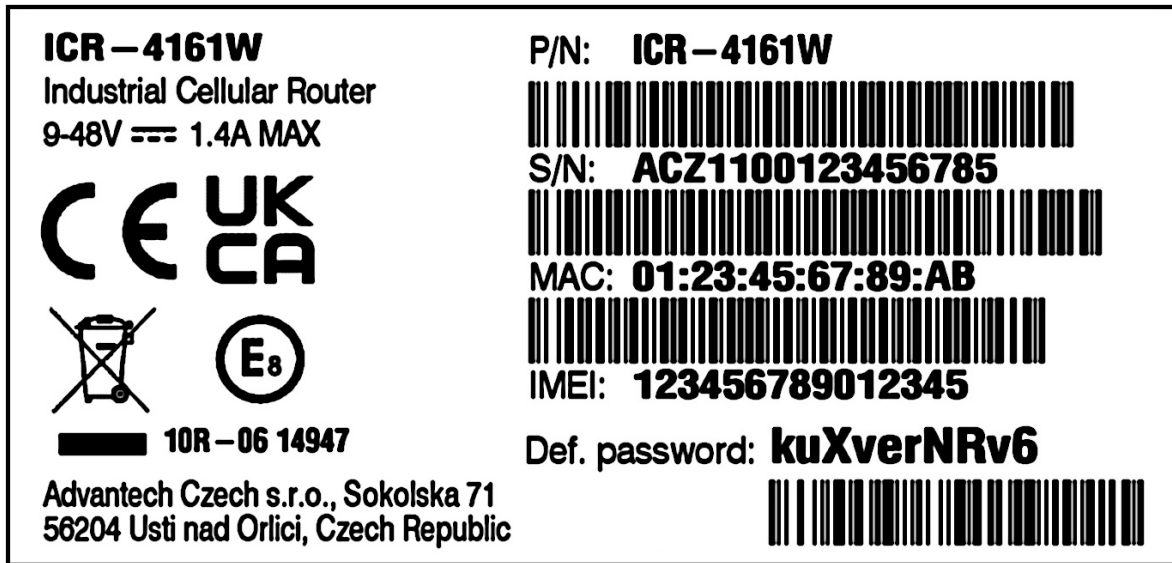



Figure 8: Product Label

1.11 First Use

You can perform the initial configuration of the router using a web browser on your PC. This interface enables router monitoring, configuration, and administration.

- 
- Before putting the router into operation, ensure that all components required for running your applications are connected. Refer to Chapter [1.2 Hardware Overview](#) for an overview of the hardware.
 - Do not operate the router without an antenna connected to the main antenna connector. Transmitted energy will be reflected by an open connector, which could potentially damage the equipment.

The procedure for connecting to a new router is described in the *Configuration Manual* [1], Chapter *Introduction* → *Configuration Environments* → *Initial Web Configuration GUI Access*. This manual also provides detailed descriptions and examples of router configuration using the web interface.

2. Hardware Functionality

See Chapter 1.2 for an overview of the product's hardware, along with links to chapters offering detailed explanations.

2.1 SIM Card Slots

Slots for two SIM cards are located on the router beneath a metal cover. If you plan to use this device for cellular network communication, insert an activated data-provisioned SIM card into the SIM card slot.

You have the option to install two SIM cards simultaneously for utilizing the switching feature. The SIM cards can have different Access Point Names (APNs) configured. The procedure for changing SIM cards is outlined below. If the SIM requires a PIN, input it in the router's web interface (*Administration* → *Unlock SIM Card*).

 Type of SIM card: Mini SIM (2FF) 25.0 × 15.0 × 0.76 mm.

Inserting the SIM card:

- Always disconnect the router from the power supply before handling the SIM card.
- Unscrew the two screws on the SIM card cover and remove the cover.
- To remove an inserted SIM card, use the protrusion on the SIM card cover, as indicated in the figure below, to gently press the SIM card into its slot until you hear a click. Upon hearing the click, release the pressure on the card, and it will automatically pop out of its slot.
- To properly insert a SIM card, gently push the card into the designated slot until you hear a confirming click. For this task, you may utilize the protrusion on the SIM card cover, which is indicated in the figure below.
- Put the cover back and secure it with the two screws.



Figure 9: SIM Cards Insertion

2.2 Antennas Interfaces

SMA female connectors (*ANT0*, *ANT1*, *ANT2*, and *ANT3*) are designated for connecting cellular antennas to the router. Refer to Table 15 for detailed module antenna mapping. The GNSS antenna's SMA female connectors are shared with the cellular connectors, allowing connection to *ANT3* for the L1 band and to *ANT1* for the L5 band. Additionally, RP-SMA female connectors labeled *WiFi* are provided for connecting WiFi antennas on models that support WiFi.



Do not run the router without connected cellular antennas as the energy from the transmission is effectively reflected by the open end and can damage the equipment.



Recommended tightening moment for screwing the antenna to the SMA connector is 0.9 Nm.

2.3 Bluetooth

The WiFi connector, situated on the right-hand side of the device, is engineered for compatibility with Bluetooth antennas. For detailed information on the Bluetooth specifications supported by our router, please refer to Chapter 3.7. The integration of Bluetooth functionality within our router encompasses three principal components:

1. **Kernel Support and Drivers:** Integrated into the router's firmware, this includes kernel-level Bluetooth support and the necessary drivers to facilitate Bluetooth connectivity.
2. **Bluetooth Router App:** This application leverages the *BlueZ* Linux Bluetooth stack to extend the router's Bluetooth functionalities. It is not pre-installed on the router. For activation, the *Bluetooth Router App* must be downloaded and installed.
3. **Node-RED Applications:** To achieve advanced Bluetooth functionalities, Node-RED and its Bluetooth node can be employed. Similar to the Bluetooth Router App, *Node-RED* and the *Node-RED Bluetooth* node are available for installation.

2.4 Ethernet Interfaces

The RJ45 panel socket is used for one ETH0 and one ETH1 Ethernet interfaces. The pinout of the socket is shown in Figure 10 and described in Table 6.

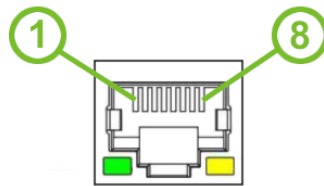

Figure 10: Ethernet Connector Pinout of RJ45 Socket

Pin	10base-T & 100base-T	1000base-T
1	Tx+ (Transmit Data+)	BI_DA+ (BiDirectional pair A+)
2	Tx- (Transmit Data-)	BI_DA- (BiDirectional pair A-)
3	Rx+ (Receive Data+)	BI_DB+ (BiDirectional pair B+)
4	—	BI_DC+ (BiDirectional pair C+)
5	—	BI_DC- (BiDirectional pair C-)
6	Rx- (Receive Data-)	BI_DB- (BiDirectional pair B-)
7	—	BI_DD+ (BiDirectional pair D+)
8	—	BI_DD- (BiDirectional pair D-)

Table 6: Ethernet Connector Pinout Description of RJ45 Socket



The isolation barrier of the Ethernet ports against the ground is 1500 V.

2.5 Power Supply

A two-pin terminal connector (pitch 3.5 mm) is utilized to power the router. The corresponding connector is included as a standard accessory with the router.

Pin	Signal mark	Description
1	VCC(+)	Positive pole of DC supply voltage (+9 to +48 V DC)
2	GND(-)	Negative pole of DC supply voltage

Table 7: Power connector pinout

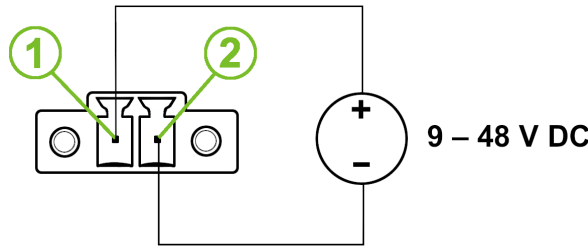

Figure 11: Power Connector Pinout

The required power supply voltage for the router ranges between +9 V and +48 V DC. Refer to the connection scheme in Figure 11 for proper setup. The router is equipped with built-in protection against reversed polarity, functioning without signaling. To guarantee correct operation, the power source must be capable of providing a sufficient amount of energy, as detailed in the consumption section of Chapter 3.1.



Grounding the router using the grounding screw eliminates the protection against reversed polarity. Ensure the negative pole of the DC power supply shares the same voltage reference as the grounding screw. A voltage difference between these points may damage the router, necessitating repairs exclusively by an authorized service center.



Unit has to be supplied by a power supply specified as a Limited Power Source (LPS) or CEC/NEC Class 2 source of supply.

All metal parts, including the box, are interconnected with the negative pole of the power supply (common pole). If recommended for the installation environment, protect the router by properly grounding it using the grounding screw, as depicted in Figure 12. The maximum tightening torque for the grounding screw is 1 Nm.

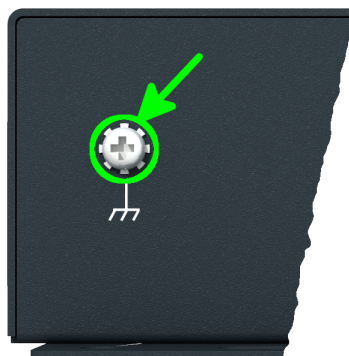

Figure 12: Position of the Grounding Screw

2.6 Low Power Mode



In applications requiring low power consumption, such as solar power (not 24/7 mode), it is strongly recommended to use the Low Power Mode (LPM) before shutting down the entire router.

LPM (Low Power Mode) is a router mode in which the router enters a sleep state with minimal power consumption; you can find details about LPM power consumption in Chapter 3.1. The router can be awakened from this mode after a predefined period of time. To put the router into LPM mode, you can use the `lpm` command; for more information, refer to the [Command Line Interface](#) application note.

2.7 USB 3.0 Port

The router is equipped with a single USB 3.0 host port featuring a USB-A type socket. The pinout details of the USB socket are illustrated in Figure 13 and further described in Table 8.

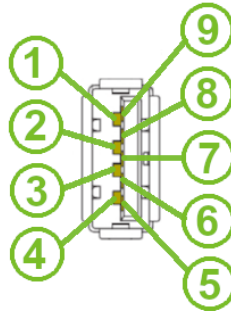

Figure 13: USB 3.0 Connector Pinout

Pin	Signal mark	Description
1	VBUS	5 V DC Power, 0.5 A
2	D-	USB 2.0 differential pair -
3	D+	USB 2.0 differential pair +
4	GND	Ground for power return
5	StdA_SSRX-	SuperSpeed receiver differential pair -
6	StdA_SSRX+	SuperSpeed receiver differential pair +
7	GND_DRAIN	Ground for signal return
8	StdA_SSTX-	SuperSpeed transmitter differential pair -
9	StdA_SSTX+	SuperSpeed transmitter differential pair +

Table 8: USB 3.0 Connector Pinout Description

For detailed USB port configuration options, refer to the configuration manual [1], Chapter *Configuration* → *USB Port*.

2.8 MicroSD Card Reader

The microSD card reader is located under the SIM cover on the router. This card reader enables the router to utilize microSD memory cards. The technical specifications are presented in Table 9.

Technical specifications of microSD card		
Supported technologies		SD, SDHC, SDXC
Supported capacity	SDHC	up to 32 GB
	SDXC	from 32 GB to 512 GB
Supported microSD card filesystems		vfat, ext2, ext3, ext4

Table 9: Technical Specifications of MicroSD Card

Inserting the microSD card:

- To remove an inserted microSD card, use the protrusion on the SIM card cover, as indicated in the figure below. Press the card slightly into its slot until you hear a click. Release the card, and it will pop out of its slot.
- To insert a microSD card, push the card into the slot with the correct orientation as shown in the picture until it clicks into place. For this task, you may utilize the protrusion on the SIM card cover again.



Figure 14: MicroSD Card Insertion

Mounting microSD Card to the System

To access the microSD card within the router's system, it must be mounted. Follow these steps to mount the card:

- Use the `dmesg` command to view the list of recently connected devices.
- Identify the entry for the microSD card in the command's output, for example:
`mmcblk0: p1`
- To mount the card to the `mnt` directory, use the `mount` command:
`mount /dev/mmcblk0p1 /mnt`

For more information about the commands for creating, mounting, checking, and unmounting a file system on a microSD card, refer to the application note for the [Ext4 Filesystem Utilities](#) router app.

2.9 LED Status Indication

There are status LEDs on the top side of the router to provide router status information. Moreover, ETH0 and ETH1 connectors, located on the front panel, have two additional LEDs providing information about the port status.











	Caption	Color	State	Description
	SIM1	Green Red	On Fast blinking	SIM1 is active for the cellular connection. A SIM1 issue (missing card or PIN not entered).
	SIM2	Green Red	On Fast blinking	SIM2 is active for the cellular connection. A SIM2 issue (missing card or PIN not entered).
	WiFi	Green Green Green Green	On Brief off blinks Fast blinking Off	AP or STA started successfully. Data transmission. AP or STA error (configuration, HW or connection). AP and STA disabled.
	SIG	Green Orange Red	On On On	Good cellular signal. Fair cellular signal. Poor cellular signal.
	USR	Green	—	The function of this LED is user-defined.
	DAT	Green	Blinking	Cellular communication is in progress.
	PWR	Green Green Green	On Blinking Fast blinking	The router is booting up. The router booted up and is ready. The router firmware is being updated.
	TECH	Green Orange Red	On On On	The active SIM uses 5G technology. The active SIM uses 4G technology. The active SIM uses 3G technology.
	ETH0 ETH1	Green Green	On Off	Selected 1 Gbps bit rate. Selected 100/10 Mbps bit rate.
	ETH0 ETH1	Yellow Yellow Yellow	On Brief off blinks Off	The network cable is connected. Data transmission. The network cable is not connected.

Table 10: LED Status Indication

2.10 Reset Functions

The *RST* button has multiple functions. For more details, refer to the configuration manual [1], Chapter *Introduction* → *Device* → *Reset*.

-  Use a narrow screwdriver or a small tool to press the *RST* button.

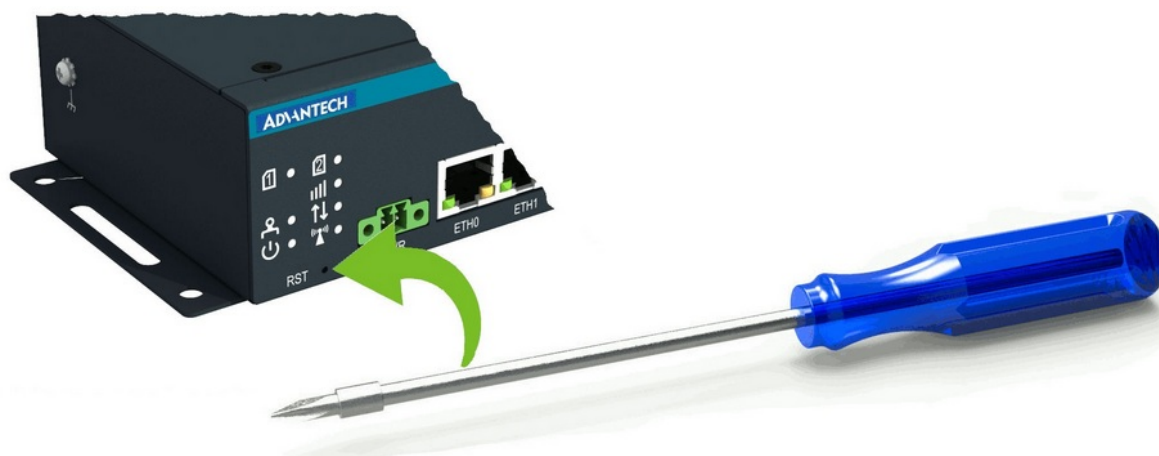

Figure 15: Resetting the Router

3. Technical Parameters

3.1 Basic Parameters

Parameter		Description
Temperature range	Operating Storage	-40 °C to +75 °C (-40 °F to +167 °F) -40 °C to +85 °C (-40 °F to +185 °F)
Humidity	Operating Storage	5 to 95 % relative humidity non condensing 5 to 95 % relative humidity non condensing
Altitude	Operating	2000 m / 70 kPa
Degree of protection		IP30
Supply voltage		9 – 48 V DC
Battery for RTC		CR1225
Consumption for non-WiFi / WiFi version	Idle Average Maximum LPM mode	4.6 W / 5.5 W 4.9 W / 6.8 W 10.5 W / 13.3 W 10 mW
Dimensions of device (w/o clips)		130 × 90 × 43 mm (5.12" × 3.54" × 1.39")
DIN rail clip specification		DIN 35 mm, EN 60715
Total weight for non-WiFi / WiFi		470 g (1.04 lbs) / 480 g (1.06 lbs)

Table 11: Basic Parameters

3.2 Standards and Regulations

Parameter	Description
Radio	EN 301 908-1, EN 301 908-2, EN 301 908-13, EN 301 908-25, EN 303 413, EN 300 328, EN 301 893
EMC	EN 301 491-1, EN 301 489-17, EN 301 489-19, EN 301 489-52, EN 61000-6-2, EN 61000-6-3, EN 55032, EN 61000-4-2, EN 61000-4-3, EN 61000-4-4, EN 61000-4-5, EN 61000-4-6
Safety	IEC 62368-1
Mechanical	EN 60529, EN 60068-2-27, EN 60068-2-64
Climatic	EN 60068-2-2, EN 60068-2-1, EN 60068-2-14, EN 60068-2-78
Transportation	E-Mark (E8), homologation number: 10R - 06 14947
National	CE, UKCA compliant
Environmental	REACH, RoHS3 and WEEE compliant

Table 12: Standards and Regulations

3.3 Type Tests and Environmental Conditions

Phenomena	Test	Description	Test levels
ESD	EN 61000-4-2	Enclosure contact	± 6 kV (crit. A)
RF field AM modulated	EN 61000-4-3	Enclosure	20 V/m (crit. A) (80 – 1000 MHz) 10 V/m (crit. A) (1 – 6 GHz)
Fast transient	EN 61000-4-4	Signal ports Power ports Ethernet ports	± 1 kV (crit. A) ± 2 kV (crit. A) ± 1 kV (crit. A)
Surge	EN 61000-4-5	Ethernet ports Power ports	± 1 kV (crit. A), shielded cab. ± 1 kV (crit. A)
RF conducted	EN 61000-4-6	All ports	10 V/m (crit. A) (0.15 – 80 MHz)
Radiated emission	EN 55032	Enclosure	Class B
Conducted emission	EN 55032	Signal ports Power ports Ethernet ports	Class B Class B Class B
Dry heat	EN 60068-2-2	Test Bb, storage +85 °C, operation +75 °C	
Cold	EN 60068-2-1	Test Ab, storage -40 °C, operation -40 °C	
Damp heat	EN 60068-2-78	95 % rel. humidity (+40 °C)	
Dry heat, cyclic	EN 60068-2-30	+55 °C / +25 °C, rel. humidity 95 %, 12 h - 12 h	
Dry heat	EN 60068-2-2	Test Bb, storage +85 °C, operation +75 °C	
Thermal shock/ temp. variation	EN 60068-2-14	Test Nb, -40 °C/+75 °C, 3h/3h, 2 cycles, 3 K/min	
Degrees of protection provided by enclosures	EN 60529	IP30	
Vibration, broadband random	EN 60068-2-64	Spectrum A.3 cat 1, breakpoints A.6 cat 1	
Shock	EN 60068-2-27	50 m/s ² , 11 ms, half sine, 10 in each dir.	

Table 13: Type Tests and Environmental Conditions

3.4 Parameters of Cellular Module

Parameter	Description
Antenna	<ul style="list-style-type: none"> • Connector type: SMA (4 pcs) • Input impedance: 50 Ω • VSWR: ≤ 3 • Efficiency: $> 30\%$
5G NR parameters	<ul style="list-style-type: none"> • 3GPP Release 16 • Supported modulations: $\pi/2$-BPSK, QPSK, 16QAM, 64QAM and 256QAM for uplink; QPSK, 16QAM, 64QAM and 256QAM for downlink • UL 2 x 2 MIMO: n38, n41, n48, n77, n78, n79 • DL 4 x 4 MIMO 5G NR SA: n1, n2, n3, n7, n25, n30, n38, n40, n41, n48, n66, n70, n77, n78, n79 • DL 4 x 4 MIMO 5G NR NSA: n1, n2, n3, n7, n25, n30, n66, n38, n40, n41, n48, n70, n77, n78, n79 • Supporting SCS 15 kHz¹ and 30 kHz¹ • SA² and NSA² operation modes on all the 5G bands • Option 3x, 3a, and Option 2 • Supported 5G NR SA & NSA bands: n1 (2100), n2 (1900 PCS), n3 (1800), n5 (850), n7 (2600), n8 (900), n12 (700 a), n13 (700 c), n14 (700 PS), n18 (800 Lower), n20 (800), n25 (1900+), n26 (850+), n28 (700 APT), n29 (700 d), n30 (2300 WCS), n38 (TD 2600), n40 (TD 2300), n41 (TD 2600+), n48 (TD 3600), n66 (AWS), n70 (AWS-4), n71 (600), n75 (DL 1500+), n76 (DL 1500-), n77 (TD 3700), n78 (TD 3500), n79 (TD 4700) • NSA TDD: max. 3.4 Gbps(DL), max. 550 Mbps (UL) • SA TDD: max. 2.4 Gbps(DL), max. 900 Mbps (UL) • Max. output power: 5G NR bands: 23 dBm ± 2 dB (Class 3) 5G NR HPUE bands (n38/n40/n41/n77/n78/n79): 26 dBm $\pm 2/-3$ dB (Class 2)

Continued on next page

¹5G NR FDD bands only support 15 kHz SCS, and NR TDD bands only support 30 kHz SCS.

²Supported bandwidth in the NSA and SA modes may differ for each frequency band.

Continued from previous page

Parameter	Description
LTE parameters	<ul style="list-style-type: none"> • 3GPP Release 16 (DL Cat 19 / UL Cat 18) • Supported modulations: QPSK, 16QAM, 64QAM and 256QAM (uplink/downlink) • 4 x 4 MIMO downlink for B1, B2, B3, B4, B7, B25, B30, B38, B40, B41, B42, B43, B48, B66 • Supported FDD bands: B1 (2100), B2 (1900 PCS), B3 (1800+), B4 (AWS-1), B5 (850), B7 (2600), B8 (900 GSM), B12 (700 a), B13 (700 c), B14 (700 PS), B17 (700 b), B18 (800 Lower), B19 (800 Upper), B20 (800 DD), B25 (1900+), B26 (850+), B28 (700 APT), B29 (700 d), B30 (2300 WCS), B32 (1500 L-band), B66 (AWS), B71 (600) • Supported TDD bands: B34 (TD 2000), B38 (TD 2600), B39 (TD 1900+), B40 (TD 2300), B41 (TD 2500+), B42 (TD 3500), B43 (TD 3700), B46 (TD Unlicensed), B48 (TD 3600) • Bandwidth: 1.4, 3, 5, 10, 15 and 20 MHz RF bandwidth • Bit rates: max. 1.6 Gbps (DL), max. 200 Mbps (UL) • Max. output power: LTE bands: 23 dBm \pm2 dB (Class 3) LTE HPUE (for single carrier) bands (B38/B41/B42/B43): 26 dBm \pm2 dB (Class 2)
UMTS parameters	<ul style="list-style-type: none"> • 3GPP Release 9, DC-HSDPA, HSPA+, HSDPA, HSUPA and WCDMA • Supported modulations: QPSK, 16QAM and 64QAM • Supported bands: B19 (800 MHz), B5 (850 MHz), B8 (900 MHz), B4 (AWS A-F 1700 MHz), B2 (PCS A-F 1900 MHz), B1 (2100 MHz) • DC-HSDPA: max. 42 Mbps (DL) • HSUPA: max. 5.76 Mbps (DL) • WCDMA: 384 kbps (DL) / 384 kbps (UL) • Max. output power: 24 dBm \pm1/-3 dB (Class 3)

Table 14: Technical Parameters of Cellular Module

3.4.1 Antenna Mapping

SMA	Description
ANT0	Antenna 0 interface: 5G NR: <ul style="list-style-type: none"> • Refarmed: LB_TX0/PRX & MHB_TX0/PRX & UHB_TX1/DRX • n41_TX0/PRX • n77/n78/n79_TX1/DRX LTE: LB_TX0/PRX & MHB_TX0/PRX & UHB_TX1/DRX WCDMA: LMB_TRX
ANT1	Antenna 1 interface: 5G NR: <ul style="list-style-type: none"> • Refarmed: MHB_PRX MIMO & UHB_PRX MIMO • n41_PRX MIMO • n77/n78/n79_PRX MIMO LTE: MHB_PRX MIMO & UHB_PRX MIMO & LAA_PRX GNSS: L5
ANT2	Antenna 2 interface: 5G NR: <ul style="list-style-type: none"> • Refarmed: MHB_TX1¹/DRX MIMO & UHB_TX0/PRX • n41_TX1/DRX MIMO • n77/n78/n79_TX0/PRX LTE: MHB_TX1 ¹ /DRX MIMO & UHB_TX0/PRX
ANT3	Antenna 3 interface: 5G NR: <ul style="list-style-type: none"> • Refarmed: LB_TX1/DRX & MHB_DRX & UHB_DRX MIMO • n41_DRX • n77/n78/n79_DRX MIMO LTE: LB_TX1/DRX & MHB_DRX & UHB_DRX MIMO & LAA_DRX WCDMA: LMB_DRX GNSS: L1

Table 15: Cellular Module Antenna Mapping

¹MHB TX1 will be active when supporting Sub 2.6 GHz EN-DC.

3.5 Parameters of GNSS

Parameter	Description
GNSS Systems	GPS, GLONASS, BDS, Galileo, QZSS
Antenna	Connector type: SMA Input impedance: 50 Ω Antenna connection: <ul style="list-style-type: none"> • shared with cellular SMA connectors • ANT3 for L1 band • ANT1 for L5 band Frequency range: <ul style="list-style-type: none"> • L1: 1559–1609 MHz • L5: 1166–1187 MHz Polarization: RHCP or linear VSWR: < 2 (Typ.) Power mode: pasive antenna only Passive antenna gain: > 0 dBi
Features	Protocol: NMEA 0183 Data update rate: 1 Hz
Frequency	GPS/Galileo/QZSS (L1): 1575.42 \pm 1.023 MHz GPS/Galileo/QZSS (L5): 1176.45 \pm 10.23 MHz Galileo (E1): 1575.42 \pm 2.046 MHz QZSS (L1): 1575.42 MHz GLONASS: 1597.5–1605.8 MHz BDS 1561.098 \pm 2.046 MHz
Sensitivity (autonomous)	Acquisition: -147 dBm Reacquisition: -160 dBm Tracking: -160 dBm
TTF (autonomous)	Cold start: 27.93 s Warm start: 11.55 s Hot start: 1.09 s
Accuracy (CEP-50) (autonomous)	1.35 m (at open sky)

Table 16: Technical Parameters of GNSS

3.6 Parameters of WiFi

Parameter	Description
Short Description	WiFi 6/6E 2x2 MU-MIMO
Supported Standards	IEEE 802.11ax/ac/a/b/g/n (2T2R) DBDC (Dual-band, Dual-concurrent)
Antenna Connectors	2x2 MU-MIMO
Access Point	up to 15 clients
Data Rate	up to 450 Mbps @ 2.4 GHz up to 950 Mbps @ 5 GHz up to 950 Mbps @ 6 GHz 802.11b: up to 11 Mbps 802.11a/g: up to 54 Mbps 802.11n: MCS0 15 802.11ac: MCS0 9 802.11ax: MCS0 13
Frequency Ranges	2.412 – 2.484 GHz 5.150 – 5.850 GHz 5.925 – 7.125 GHz
Spectrum Widths	20/40 MHz @ 2.4 GHz 20/40/80/160 MHz @ 5/6 GHz
Modulation	802.11b: DSSS (DBPSK, DQPSK, CCK) 802.11g: OFDM (BPSK, QPSK, 16-QAM, 64-QAM) 802.11n: OFDM (BPSK, QPSK, 16-QAM, 64-QAM) 802.11a: OFDM (BPSK, QPSK, 16-QAM, 64-QAM) 802.11ac: OFDM (BPSK, QPSK, 16-QAM, 64-QAM, 256-QAM) 802.11ax: OFDMA (BPSK, QPSK, 16-QAM, 64-QAM, 256-QAM, 1024-QAM)
Type of Device	Access point (AP) Station (STA) Multi-role (AP & STA)
Security – Standards	WPA, WPA2, WPA3, 802.1X
Security – Encryption	WEP, TKIP, AES
TX Power	max. 19 dBm @ 2.4 GHz max. 19 dBm @ 5 GHz max. 13.5 dBm @ 6 GHz

Table 17: Technical Parameters of WiFi

3.7 Parameters of Bluetooth

Parameter	Description
Bluetooth Standards	V5.2, V5.1, V5.0, V4.2, V4.1, V4.0LE, V3.0, V2.1+EDR
Antenna	Shared with right RP-SMA connector
Frequency Range	2.412GHz 2.484GHz
Data Rate	1 Mbps, 2 Mbps and Up to 3 Mbps
Modulation	Header: GFSK Payload 2M: $\pi/4$ -DQPSK Payload 3M: 8-DPSK
Receive Sensitivity	<0.1 % BR, BER at -70 dBm
Output Power	$\leq +14$ dBm

Table 18: Technical parameters of Bluetooth

3.8 System Configuration

The main parameters of the system are listed in Table 19.

Parameter	Description
CPU architecture	Quad-Core ARM Cortex-A53
CPU frequency	1.6 GHz
CPU power	2.3 DMIPS/MHz
Flash memory	8 GB of eMMC <ul style="list-style-type: none"> • 2.18 GB for Router Apps (/opt) • 474 MB for customer data (/var/data) • 231 MB for system extensions (/) • The remaining space is reserved for the system.
RAM size	1 GB
Watchdog	HW watchdog
RTC	Battery backup RTC
TPM	Trusted Platform Module (TPM) 2.0
SIM Slots	2× SIM (Mini SIM – 2FF) 1× Chip SIM (MFF2) ¹

Table 19: System Configuration

¹Not assembled by default, for dedicated customer orders only.

Appendix A: Troubleshooting

If you cannot connect to the router from your PC, your network card may be configured in such a way that it is not possible to connect to the router. Take one or more of the following steps in order to solve the problem:

- Make sure your PC's network card is configured to obtain the IP address from the DHCP server (by default the DHCP server is running in the router).
- Connect the router to the PC via Switch.
- Connect the router to the PC, start the router first and then start the PC after the router's initialization.

Ethernet connection fails or is not establishing.

- It is possible to turn auto negotiation off and set a rate and duplex manually on the Ethernet interface of the router. Available on "LAN Configuration" page in the router.

Mobile WAN connection fails.

- Check the signal power ("Mobile WAN status" page). If the signal power is weak, you will have to use a better antenna. If the neighbouring cells have a similar signal strength, you will need to use a directional antenna. For proper operation, the signal levels have to be good.
- Try to enable automatic ping from the router, which will check the connection when there are no data running and in the case of a failed ping, restart the connection. This can be done on the "Mobile WAN Configuration" page in the router in the "Check connection" section. "Enable + bind" option is to ensure the ping goes always through Mobile WAN network interface.

Mobile WAN connection cannot be established.

- Check the "Mobile WAN Configuration" – APN, name, password and IP address (all can be blank).
- Try to enter the SIM card PIN – verify that the SIM card has the PIN code entered. Available on "Unlock SIM Card" page in the "Administration" section.
- In a private APN it is not recommended to get the DNS settings from operator (on "Mobile WAN" page)
- Go to "System Log" page in "Status" section and observe where the error occurs.

I cannot connect from the Internet to the device behind the router. I have NAT enabled.

- The device's gateway has to be configured so it points to the router.

I can't access my Web server placed behind the router over NAT.

- The remote HTTP access to the router has to be disabled on "NAT Configuration" page in the router. Also enable "Send all remaining incoming packets to default server" feature and fill in the IP address of your Web server. On the Web server, the default gateway has to be the IP address of the router.

DynDNS doesn't work.

- With private APN this will not work.

- If the same IP address is recorded in your canonic name as a dynamically assigned address, it means that the operator is using NAT or a firewall.
- You can verify NAT using ping to your server with static address and then compare with router's IP address.
- You can verify a Firewall by accessing remotely to the router's Web interface.
- The operator may not provide the address of DNS server and without DNS server's address it is impossible to connect to the dyndns.org server. The following messages will be shown in the System Log:
 - DynDNS daemon started
 - Error resolving hostname: no such file or directory
 - Connect to DynDNS server failed

 **L2TP or IPSec isn't establishing.**

- Check the "System Log" page for error messages.

 **IPSec tunnel establishes but the communication does not run.**

- Probably there are bad routing rules defined in the connected devices, or the default gateway.

 **I switched the router to offline mode by SMS message, but the router is in online mode after reboot.**

- SMS messages do not change the router configuration. They remain in effect only until the router is rebooted.

Is the router Cisco compatible? Can I use the Cisco configuration?

- No, the Firmware in the router (ICR-OS) is based on Linux with BusyBox. Thus the Cisco configuration cannot be used. But network connections are defined by standards so connecting the router to the Cisco or other networking devices is possible and will be compatible.

FTP or SFTP does not work

- FTP will work on v2 routers only. You can use SFTP on all routers to transfer files to/from the router. If having troubles with FTP on v2 routers, make sure you have FTP enabled: "Configuration" section, "Services", "FTP". Then you can connect with any client on port 21 with name and password same as for the Web interface. If having troubles with SFTP, make sure you have SSH enabled: "Configuration" section, "Services", "SSH". Then you can connect with any client on port 22 with name and password same as for the Web interface.

How can I connect to the router's command line? (SSH, Telnet)

- You can use SSH on all routers or Telnet on v2 routers only. SSH is enabled by default, but you can verify in Web interface in "Configuration" section, "Services", "SSH". Then connect with any SSH client on port 22 of the router. User and password is the same as for the Web interface. Telnet on v2 routers can be enabled here: "Configuration" section, "Services", "Telnet".

Appendix B: Customer Support

Customer Support for Europe

Advantech Czech s.r.o.

Sokolska 71
562 04, Usti nad Orlici
Czech Republic

Phone: +353 91 792444
Fax: +353 91 792445
E-mail: iiotcustomerservice@advantech.eu
Web: www.advantech.com

Customer Support for NAM

Advantech B+B SmartWorx

707 Dayton Road
Ottawa, IL 61350 USA

Phone: +1-800-346-3119 (Monday – Friday, 7 a.m. to 5:30 p.m. CST)
Fax: +1-815-433-5109
E-mail: support.iiot.ana@advantech.com
Web: www.advantech.com

Customer Support for Asia

Phone: +886-2-2792-7818 #1299 (Monday – Friday, 9 a.m. to 5:30 p.m. UTC+8)
Fax: +886-2-2794-7327
E-mail: icg.support@advantech.com.tw
Web: www.advantech.com

Appendix C: Regulatory & Safety Information

Safety Notices



Please, observe the following instructions:

- The router must adhere to all relevant international and national laws, including any specific restrictions governing its use in designated applications and environments.
- To prevent potential injury and appliance damage, ensure compliance with regulations by using only authorized accessories. Unauthorized modifications or use of unapproved accessories could damage the router, violate regulations, and void the warranty.
- Do not attempt to open the router.
- Before handling the SIM card, turn off the router and disconnect it from the power supply.
- **Caution!** This equipment is not suitable for use in areas with children. Small children could swallow the SIM card.
- Ensure the power supply does not exceed 48 V DC maximum.
- Avoid exposing the router to extreme ambient conditions. Safeguard it against dust, moisture, and high temperatures.
- Only deploy routers with appropriate certification and labeling in environments containing flammable or explosive materials, such as gas stations, chemical plants, or areas involving explosives. Users must observe restrictions pertaining to radio device usage in such settings.
- When traveling by plane, switch off the router. Using it onboard could jeopardize flight operations, disrupt mobile networks, and potentially violate regulations. Non-compliance may result in telephone service suspension, cancellation, or legal repercussions.
- Exercise heightened caution when operating the router near personal medical devices like cardiac pacemakers or hearing aids.
- The router may cause interference when operated in close proximity to TV sets, radio receivers, or personal computers.
- It's advisable to create a suitable backup of all critical settings stored in the device's memory.



Product Disposal Instructions

The WEEE (Waste Electrical and Electronic Equipment: 2012/19/EU) directive was introduced to ensure that electrical/electronic products are recycled using the best available recovery techniques to minimize the environmental impact. This product contains high quality materials and components which can be recycled. At the end of its life this product **MUST NOT** be mixed with other commercial waste for disposal. The device contains a battery. Remove the battery from the device before disposal. The battery in the device needs to be disposed of apart accordingly. Check the terms and conditions of your supplier for disposal information.

Appendix D: Related Documents

[1] *ICR-4[12]00 Configuration Manual* (see *Documents to download* → *Manuals* section)



[EP] Product-related documents and applications can be obtained on **Engineering Portal** at <https://icr.advantech.com/download> address.



We, Advantech Czech s.r.o., declare that the radio equipment narrated in this user's manual complies with Directive **2014/53/EU**.



We, Advantech Czech s.r.o., declare that the radio equipment narrated in this user's manual complies with Radio Equipment Regulations 2017 (**S.I. 2017 No. 1206**).

The full text of the EU Declaration of Conformity is available at the following internet address:
icr.advantech.com/doc