

Hardware Manual

5G Industrial Router

ICR-4461

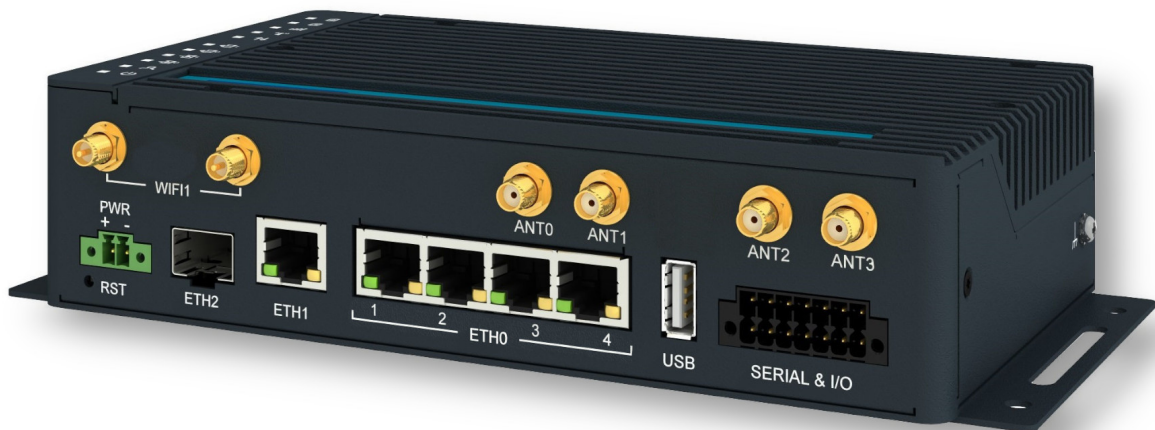

© 2024 Advantech Czech s.r.o. No part of this publication may be reproduced or transmitted in any form or by any means, electronic or mechanical, including photography, recording, or any information storage and retrieval system without written consent. Information in this manual is subject to change without notice, and it does not represent a commitment on the part of Advantech.

Advantech Czech s.r.o. shall not be liable for incidental or consequential damages resulting from the furnishing, performance, or use of this manual.

All brand names used in this manual are the registered trademarks of their respective owners. The use of trademarks or other designations in this publication is for reference purposes only and does not constitute an endorsement by the trademark holder.

Used symbols



Danger – Information regarding user safety or potential damage to the router.



Attention – Problems that can arise in specific situations.



Information – Useful tips or information of special interest.



Contents

1. Product Overview	1
1.1 Product Introduction	1
1.2 Usage Examples	2
1.3 Hardware Overview	6
1.4 Order Codes	8
1.5 Package Contents	9
1.6 Product Dimensions	10
1.7 Mounting Recommendations	12
1.8 Wall Mounting	13
1.9 DIN Rail Mounting	14
1.10 Product Label	15
2. Hardware Functionality	16
2.1 SIM Card Slots	16
2.2 Antennas Interfaces	17
2.3 Bluetooth	17
2.4 Ethernet Interfaces	18
2.5 Power over Ethernet (PoE) PSE	19
2.6 SFP Cage	21
2.7 Power Supply	22
2.8 Low Power Mode	24
2.9 I/O Port Interfaces	25
2.10 Serial Interfaces	26
2.11 USB Port	27
2.12 MicroSD Card Reader	28
2.13 LED Status Indication	29
2.14 Reset Functions	30
3. First Use	31
3.1 Accessories Connection	31
3.2 Router Configuration	31
4. Technical Parameters	32
4.1 Basic Parameters	32
4.2 Standards and Regulations	33
4.3 Type Tests and Environmental Conditions	34
4.4 Parameters of Cellular Module	35
4.4.1 Antenna Mapping	37
4.5 Parameters of GNSS	38
4.6 Parameters of WiFi	39
4.7 Parameters of Bluetooth	40
4.8 Parameters of I/O Ports	40
4.9 Parameters of Serial Interfaces	41
4.10 Parameters of PoE	41
4.11 System Configuration	41

Appendix A: Troubleshooting	42
Appendix B: Customer Support	45
Appendix C: Regulatory & Safety Information	46
Appendix D: Related Documents	47

List of Figures

1	Cellular Internet Access	2
2	Backup for Internet Access	3
3	VPN Networks Interconnection	4
4	Serial Gateway	5
5	Router Hardware Overview: Front View	6
6	Router Hardware Overview: Rear View	7
7	Router Dimensions – Front, Top and Right view with Wall Mounting holder	10
8	Router Dimensions – Front, Top and Right view with DIN holder	11
9	Rotated Wall Mounting Clips	13
10	Default Position of the DIN Rail Clips	14
11	Removing Router from the DIN Rail	14
12	Product Label	15
13	SIM Cards Insertion	16
14	Ethernet Connector Pinout of RJ45 Socket	18
15	PoE PSE Funcional Scheme	19
16	SFP Module Installation	21
17	Power Connector Pinout	22
18	Position of the Grounding Screw	23
19	I/O Connector Pinout	25
20	Functional Scheme of the Digital Interface	25
21	Serial Connector Pinout	26
22	USB Connector Pinout	27
23	MicroSD Card Insertion	28
24	Resetting the Router	30

List of Tables

1	Router Hardware Overview: Front View	6
2	Router Hardware Overview: Rear View	7
3	Order Codes Overview	8
4	Contents of Package	9
5	Ethernet Connector Pinout Description of RJ45 Socket	18
6	PoE PSE Parameters	20
7	Tested SFP Modules	21
8	Power connector pinout	22
9	Connection of I/O Ports	25
10	Connection of RS232	26
11	Connection of CAN Bus	26
12	Connection of RS485	26
13	USB Connector Pinout	27
14	Technical Specifications of MicroSD Card	28
15	LED Status Indication	29
16	Basic Parameters	32
17	Standards and Regulations	33
18	Type Tests and Environmental Conditions	34
19	Technical Parameters of Cellular Module	36
20	Cellular Module Antenna Mapping	37
21	Technical Parameters of GNSS	38
22	Technical Parameters of WiFi	39
23	Technical parameters of Bluetooth	40
24	Electrical Characteristics of Digital Input	40
25	Parameters of Serial Interfaces	41
26	System Configuration	41

1. Product Overview

1.1 Product Introduction

The ICR-4461 is positioned as a **5G NR** (New Radio) / **LTE** (DL Cat 19 / UL Cat 18) router and a powerful edge computing gateway, tailored for the international market, including the NAM region.

Thanks to its ultra high-speed data transfer capabilities, offering up to **3.4 Gbps for downloads** and **900 Mbps for uploads**, this router is an ideal solution for demanding IoT applications, including industrial routers and gateways, digital signage, industrial computers, and tablets, among others.

For optimal performance on the cellular network, the router utilizes **4x4 MIMO** technology. Two antennas for **GNSS** can be connected to the router using shared SMA connectors with the cellular antennas. Models equipped with WiFi offer **WiFi** functionality, utilizing **2x2 MIMO** antennas for enhanced wireless performance.

Housed within a robust metal enclosure, the router features two **SIM card slots** for cellular connection redundancy. It is also outfitted with five **1Gb Ethernet ports** and an **SFP cage**, plus interfaces for **RS232**, **RS485**, and **CAN bus**. Furthermore, it provides two **digital inputs** and two **digital outputs** for comprehensive connectivity and control options. A **microSD card** slot is included to enhance storage options.

The router features a **Low Power Mode** and a **hardware watchdog** for automated status monitoring and system restarts, supplemented by additional diagnostic functionalities to bolster overall reliability.

Router configuration is accessible through a **secure web interface**, offering detailed insights into the entire configuration, statuses, signal strength, and logs.

Basic features include **two-factor authentication**, **IPv6 Dual Stack**, **DHCP**, **NAT**, **NAT-T**, **DynDNS**, **DNS proxy**, **VLAN**, **QoS**, **NTP**, **VRRP**, **SMS control**, **port forwarding**, and **connection backup**, among others. The router supports various VPN protocols, including **IPSec**, **OpenVPN**, **GRE**, **L2TP**, and **PPTP**, ensuring secure communication.

The router allows for the insertion of **Linux scripts** for automated tasks. It supports the definition of up to **four distinct profiles**, switchable via the web interface, SMS, or digital input.

Router Apps enhance router functionality through custom software programs. For Advantech routers, a diverse array of Router Apps is offered, encompassing categories such as connectivity, routing, services, among others, freely accessible on the Advantech [Router Apps](#) webpage. Additionally, directly from the router web interface, you can use an **Advantech public server** for the Router App or router firmware installation/update.

Compatibility with Advantech's **remote device management** platforms, [WebAccess/DMP](#) and [WebAccess/VPN](#), offers extensive device management and monitoring, ensuring that devices remain up-to-date and secure.

1.2 Usage Examples

Cellular Internet Access

- This example demonstrates a common scenario where the cellular router facilitates access from a local LAN to the Internet via the cellular network.
- This functionality is not available on LAN routers lacking a cellular interface.

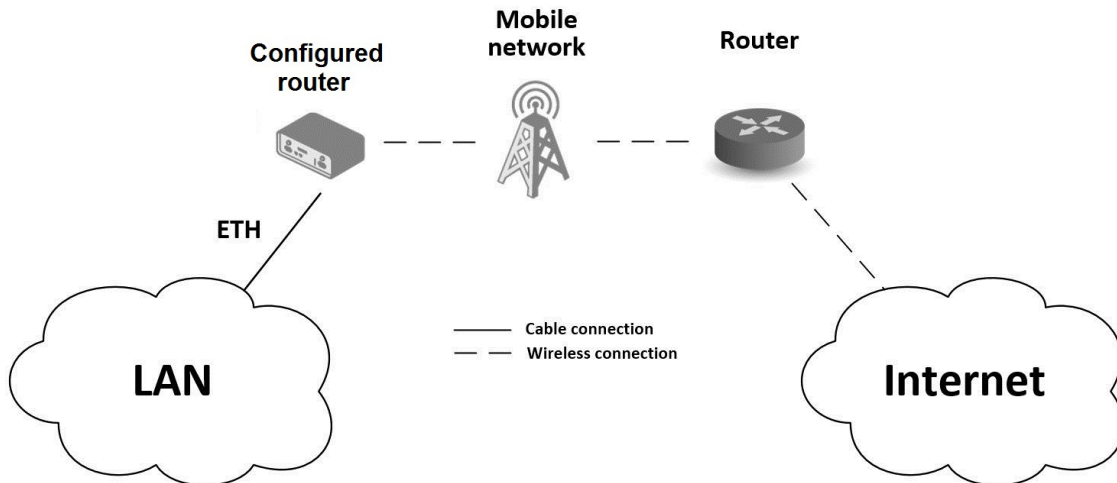

Figure 1: Cellular Internet Access

Backup for Internet Access

- This example showcases how a cellular router’s Internet access can be backed up.
- Backup options include PPPoE connections, Ethernet wired connections or WiFi.

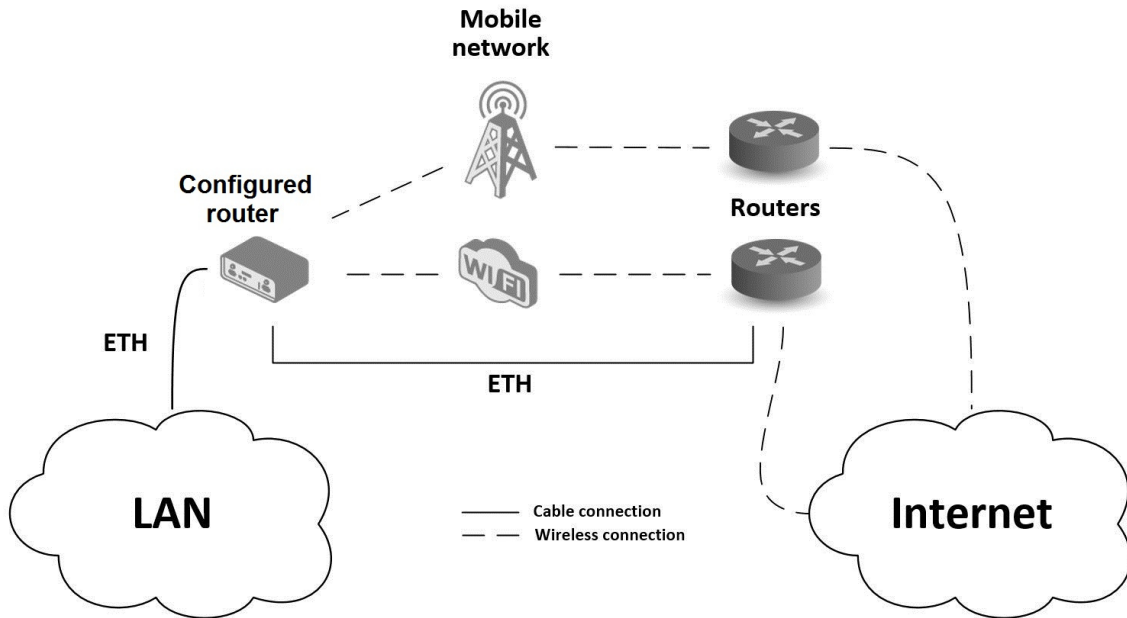

Figure 2: Backup for Internet Access

VPN Networks Interconnection

- This example highlights the establishment of a secure VPN tunnel for interconnecting the configured Advantech router with a router in a remote network, facilitated via the Internet.
- The configured router connects to the Internet using the cellular network.

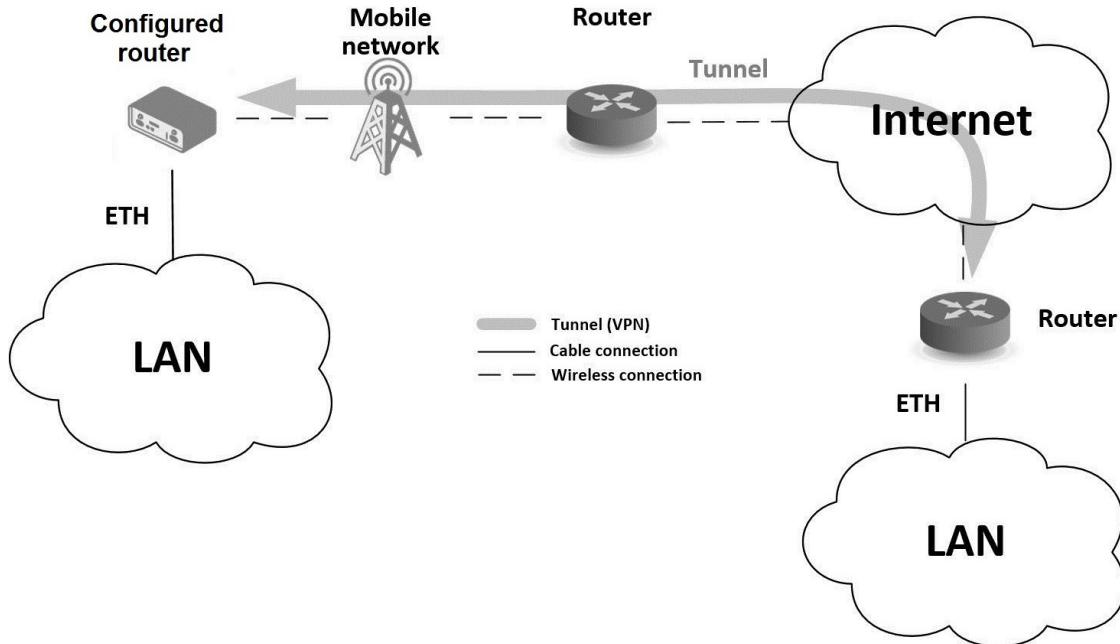

Figure 3: VPN Networks Interconnection

Serial Gateway

- This example depicts a scenario where the configured Advantech router grants access to a PLC device interfaced serially with the router.
- The PLC device, accessible over the entire Internet network, can be controlled from a remote local network, such as one running a SCADA system.
- This functionality is exclusive to routers equipped with a serial interface.

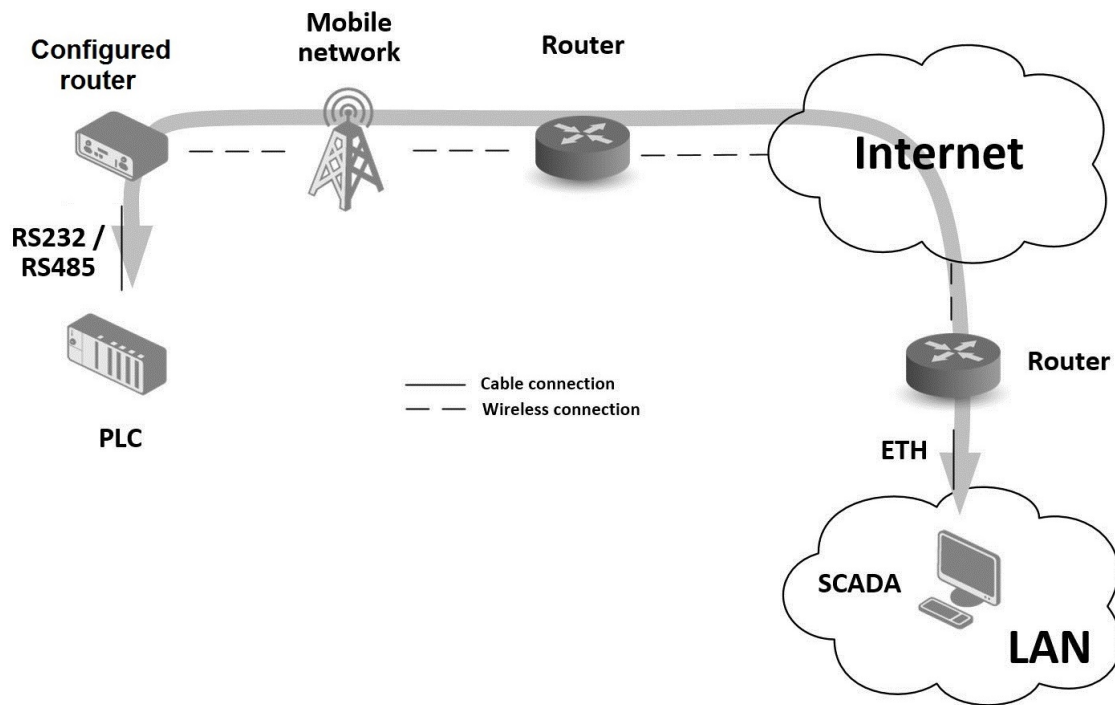

Figure 4: Serial Gateway

1.3 Hardware Overview

In this chapter, all components of the router case are described, including links to chapters that provide more details.

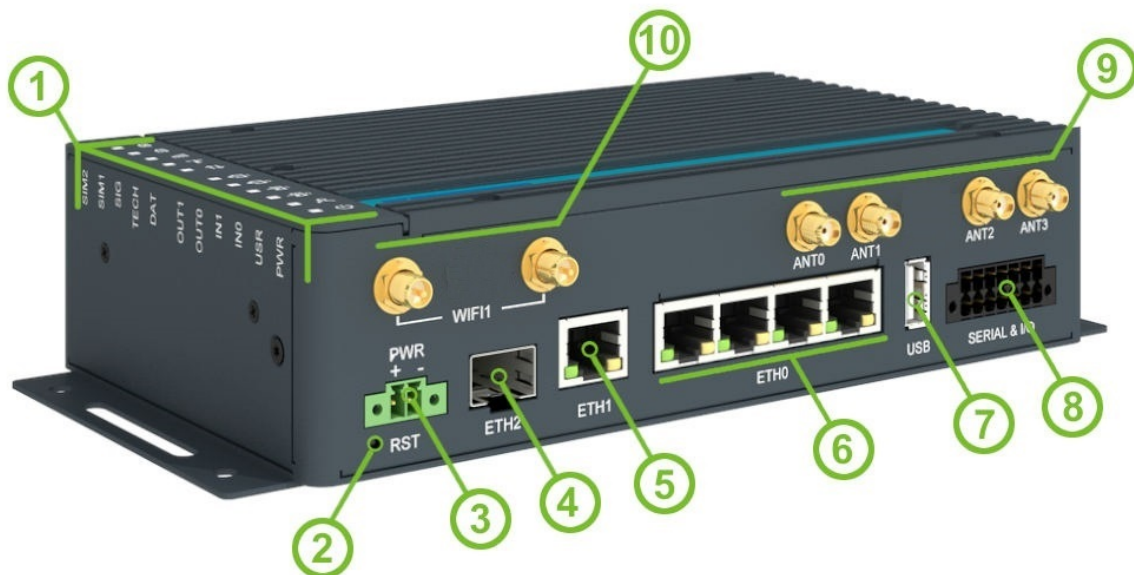

Figure 5: Router Hardware Overview: Front View

#	Item/Caption	Type	Description
1	LEDs	—	Status LED indication; see Chapter 2.13.
2	RST	—	Button to reboot the router or to restore the default configuration; see Chapter 2.14.
3	PWR	2-p term.	Power supply socket; see Chapter 2.7.
4	ETH2	SFP cage	SFP cage socket see Chapter 2.6.
5	ETH1	RJ45	1 Gb Ethernet for the second LAN; see Chapter 2.4.
6	ETH0	RJ45	1 Gb Ethernet switched connection (with four ports) for the first LAN; see Chapter 2.4.
7	USB	USB-A	USB 2.0 host port; see Chapter 2.11.
8	SERIAL & I/O	14-pin terminal	RS232, RS485, CAN bus, digital input, and digital output interfaces. See Chapter 2.9 for more information, Chapter 4.8 for I/O parameters, and Chapter 4.9 for serial interface parameters.
9	ANT0, ANT1, ANT2, ANT3	SMA female	Cellular module antenna connectors. ANT1 and ANT3 are shared with GNSS. See Chapter 2.2 for more information, Chapter 4.4 for cellular module parameters and Chapter 4.5 for GNSS parameters.
10	WIFI1	RP-SMA female	Connectors for the WiFi antennas. See Chapter 2.2 for more information and Chapter 4.6 for WiFi parameters. The WiFi connector located on the right-hand side can be used for a Bluetooth antenna; see Chapter 2.3 for more information and Chapter 4.7 for Bluetooth parameters.

Table 1: Router Hardware Overview: Front View



Figure 6: Router Hardware Overview: Rear View

#	Item/Caption	Type	Description
11	Grounding screw	M3	Pay attention to proper grounding; see Chapter 2.7.
12	SIM slots microSD slot	Mini SIM microSD	Two Mini SIM card slots; see Chapter 2.1 for more information and Chapter 4.4 for cellular module parameters. MicroSD card slot; see Chapter 2.12.
13	Wall clips	—	Wall mounting clips, included as standard accessories; see Chapter 1.8.

Table 2: Router Hardware Overview: Rear View

1.4 Order Codes

Order codes overview is shown in the table below.

Order code	Configuration
ICR-4461	5G NR cellular module, Gb ETH SWITCH, GNSS, SFP cage, USB, microSD card slot, RS232, RS485, CAN bus, two digital inputs, two digital outputs, two SIM readers
ICR-4461S	5G NR cellular module, Gb ETH SWITCH, GNSS, SFP cage, PoE PSE , USB, microSD card slot, RS232, RS485, CAN bus, two digital inputs, two digital outputs, two SIM readers
ICR-4461W3	5G NR cellular module, Gb ETH SWITCH, GNSS, SFP cage, dual-band WiFi , USB, microSD card slot, RS232, RS485, CAN bus, two digital inputs, two digital outputs, two SIM readers
ICR-4461W3S	5G NR cellular module, Gb ETH SWITCH, GNSS, SFP cage, PoE PSE, dual-band WiFi , USB, microSD card slot, RS232, RS485, CAN bus, two digital inputs, two digital outputs, two SIM readers
ICR-4461-1ND	5G NR cellular module, FirstNet , Gb ETH SWITCH, GNSS, SFP cage, USB, microSD card slot, RS232, RS485, CAN bus, two digital inputs, two digital outputs, two SIM readers
ICR-4461S-1ND	5G NR cellular module, FirstNet , Gb ETH SWITCH, GNSS, SFP cage, PoE PSE , USB, microSD card slot, RS232, RS485, CAN bus, two digital inputs, two digital outputs, two SIM readers
ICR-4461W3-1ND	5G NR cellular module, FirstNet , Gb ETH SWITCH, GNSS, SFP cage, dual-band WiFi , USB, microSD card slot, RS232, RS485, CAN bus, two digital inputs, two digital outputs, two SIM readers
ICR-4461W3S-1ND	5G NR cellular module, FirstNet , Gb ETH SWITCH, GNSS, SFP cage, PoE PSE, dual-band WiFi , USB, microSD card slot, RS232, RS485, CAN bus, two digital inputs, two digital outputs, two SIM readers

Table 3: Order Codes Overview

1.5 Package Contents

The standard set of router includes items listed in the following table:





Item#	Description	Figure	Q'ty
1	Router		1 pcs
2	Wall clips for wall mounting (screwed on the router)		2 pcs
3	2-pin terminal block for power supply (deployed on the router)		1 pcs
4	14-pin terminal block for RS232, RS485, CAN BUS, and I/O (deployed on the router)		1 pcs
5	Printed <i>Quick Start Guide Leaflet</i>		1 pcs

Table 4: Contents of Package

1.6 Product Dimensions

For the dimensions of the router see the figures below. Note that all sizes are measured in millimeters.

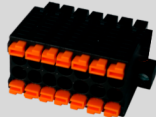
Variant with Wall Mounting Clip

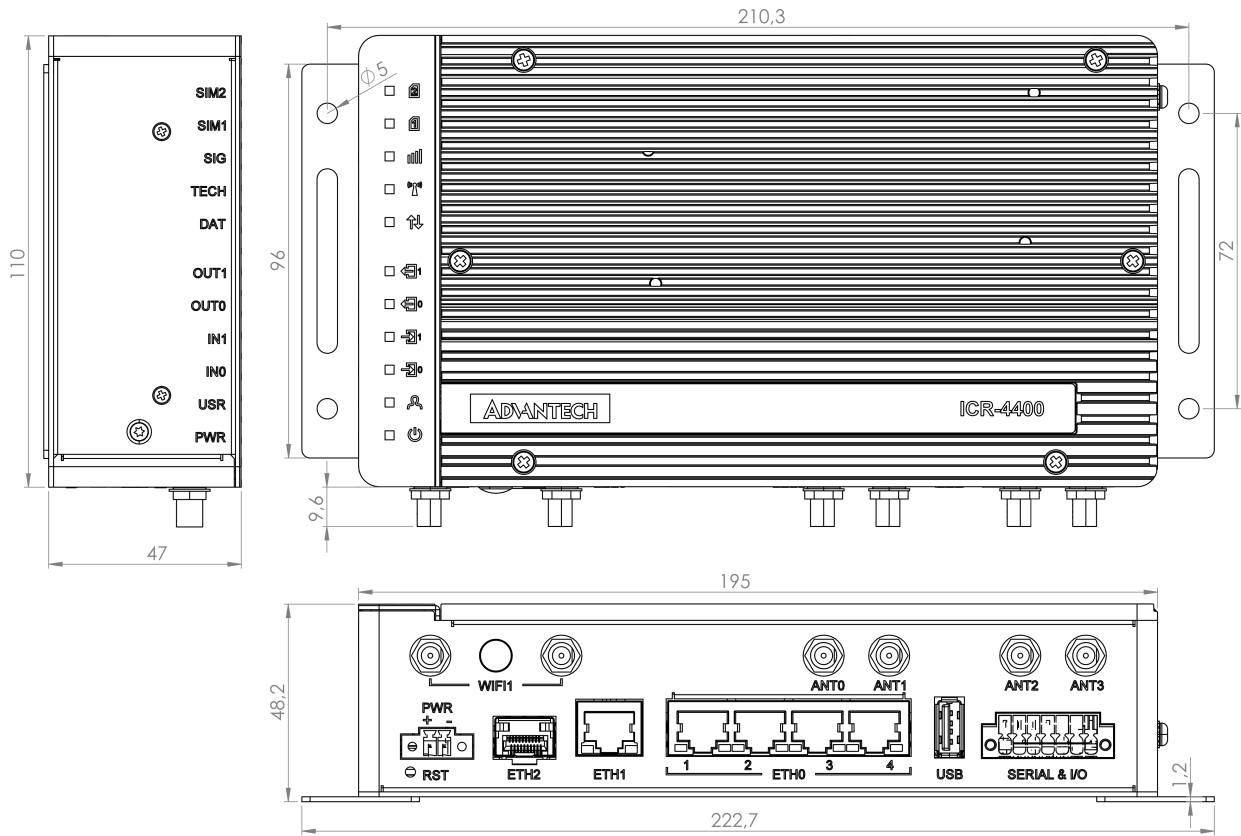

Figure 7: Router Dimensions – Front, Top and Right view with Wall Mounting holder

Variant with DIN Rail Clip

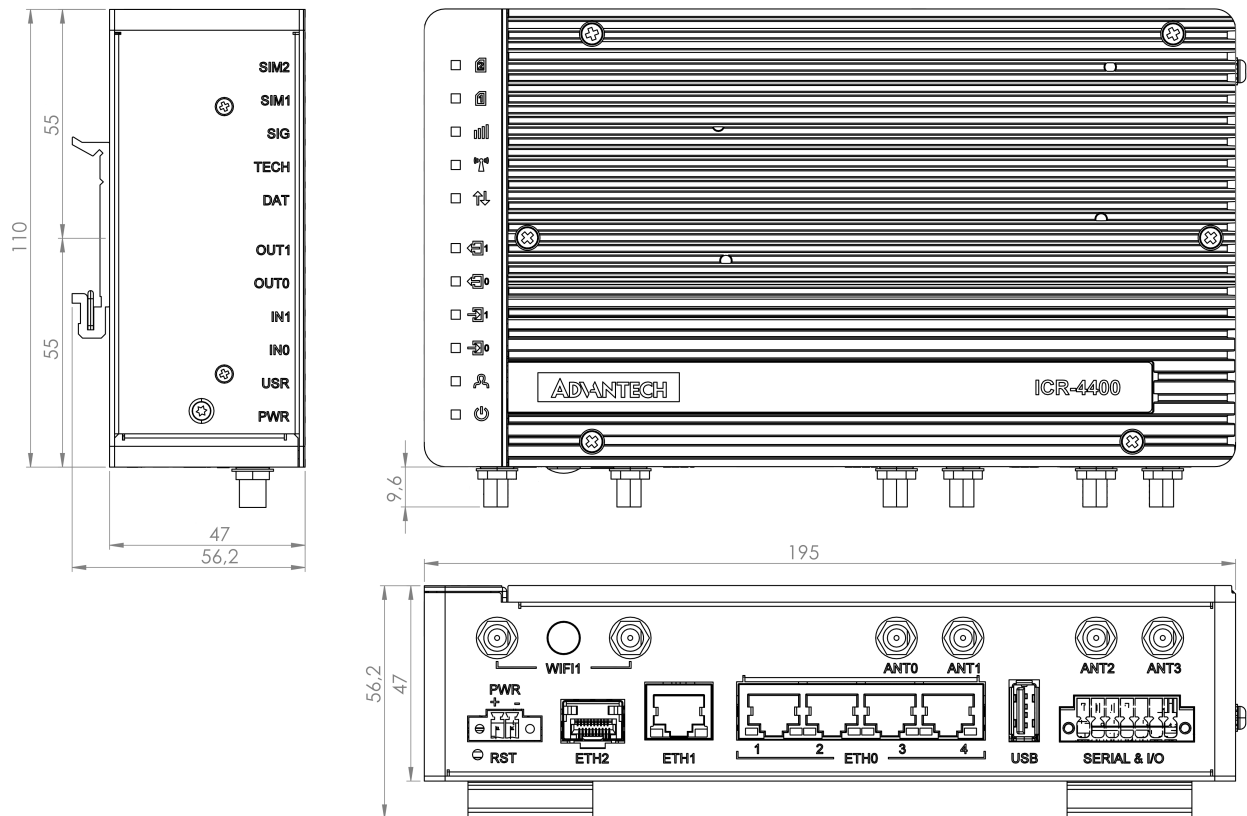

Figure 8: Router Dimensions – Front, Top and Right view with DIN holder

1.7 Mounting Recommendations

The router can be placed in the following ways:

- On a flat surface.
- On a wall using the wall mounting clip (refer to Chapter 1.8).
- On a DIN rail EN 60715 with the metal DIN rail clip (refer to Chapter 1.9).

For most applications involving a built-in router within a switchboard, two types of environments are typically encountered:

- A non-public industrial environment with low voltage but high interference.
- A public environment with low voltage and without high interference.

For both of these environments, it's feasible to mount the router to a switchboard, eliminating the need for immunity examination or EMC-related issues as per EN 61439-1:2011 standards.



To comply with the EN 61439-1:2011 specification, follow these assembly instructions when attaching a router to a switchboard:

- When using whip antennas, maintain a minimum distance of 6 cm from cables and metal surfaces on all sides to avoid interference. If an external antenna is used apart from the switchboard, a lightning conductor is necessary.
- When mounting a router on sheet steel, consider using a cable antenna.

For all cables, it's recommended to bundle them, following these guidelines:

- The combined length of the cable bundle (power supply and data cables) should not exceed 1.5 m. If data cable length surpasses 1.5 m or if the cable runs toward the switchboard, installing surge protectors is advisable.
- Data cables must not be bundled with mains voltage cables (230 V/50 Hz or 120 V/60 Hz).
- Ensure sufficient space is left between each connector for cable handling.
- For proper router functionality, use an earth-bonding distribution frame to ground the grounding screw (refer to Chapter 2.7).

1.8 Wall Mounting

i The wall mounting clip is included as a standard accessory with the router.

The router can be affixed to a wall or another surface using the wall mounting clips. Two wall mounting clips are pre-assembled to the router during production and need to be rotated as shown in Figure 9.

Each clip features two holes with a diameter of 5 millimeters for screw placement. For precise mounting dimensions, refer to Figure 7 in Chapter 1.6.

! When attaching the wall mounting clip, tighten the screws with a maximum torque of 0.4 Nm.

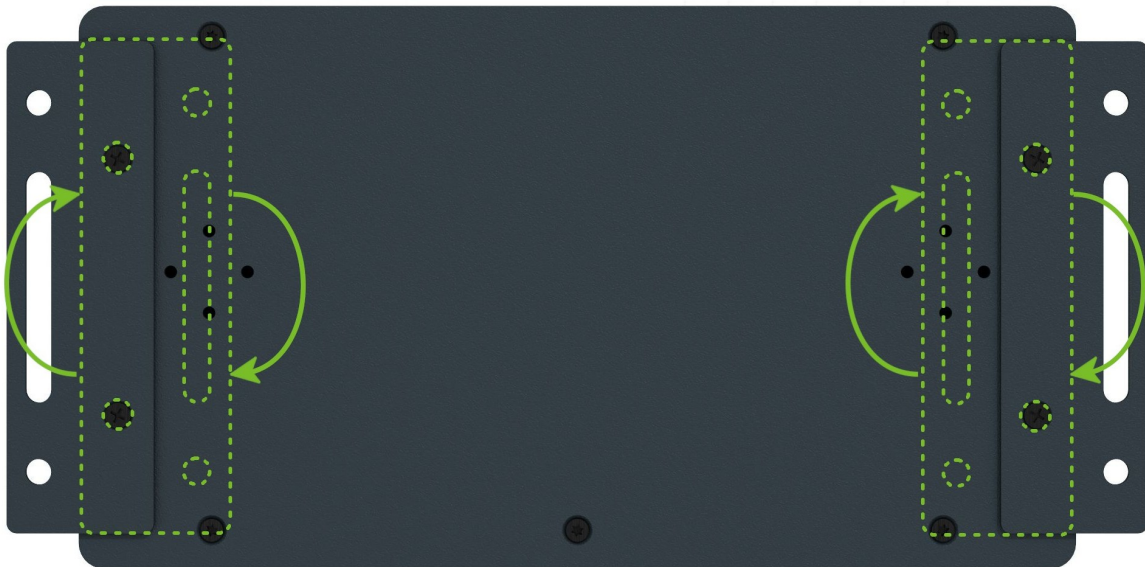

Figure 9: Rotated Wall Mounting Clips

1.9 DIN Rail Mounting



The DIN rail clips are not included as standard accessories with the router. However, they can be ordered using the order code *BB-DIN-ICR32* (two pieces for one router).

You can attach two DIN rail clips to the router for mounting it onto a DIN rail that complies with the 60715 standards. The default position of the clips is depicted in Figure 10. If necessary, the clips can also be rotated vertically.



When attaching the clips, tighten the screws with a maximum torque of 0.4 Nm.



Figure 10: Default Position of the DIN Rail Clips

To remove the router from the DIN rail, lightly push down on the router to disengage the bottom part of the DIN rail clip from the rail. Then, pivot the bottom part of the router away from the DIN rail, as demonstrated in Figure 11.

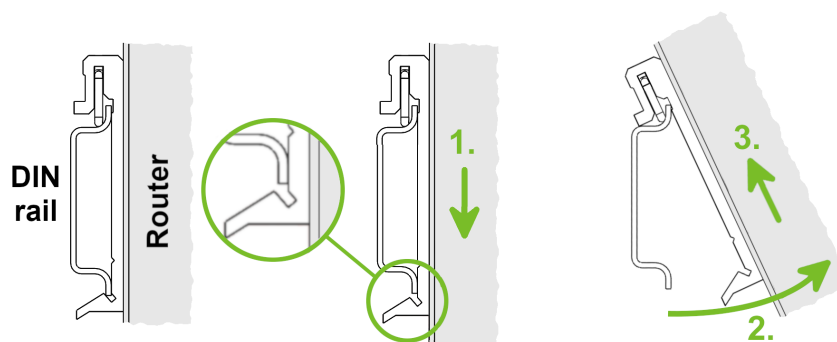

Figure 11: Removing Router from the DIN Rail

1.10 Product Label

The figure below shows an example of the product labels with all the information printed on them.

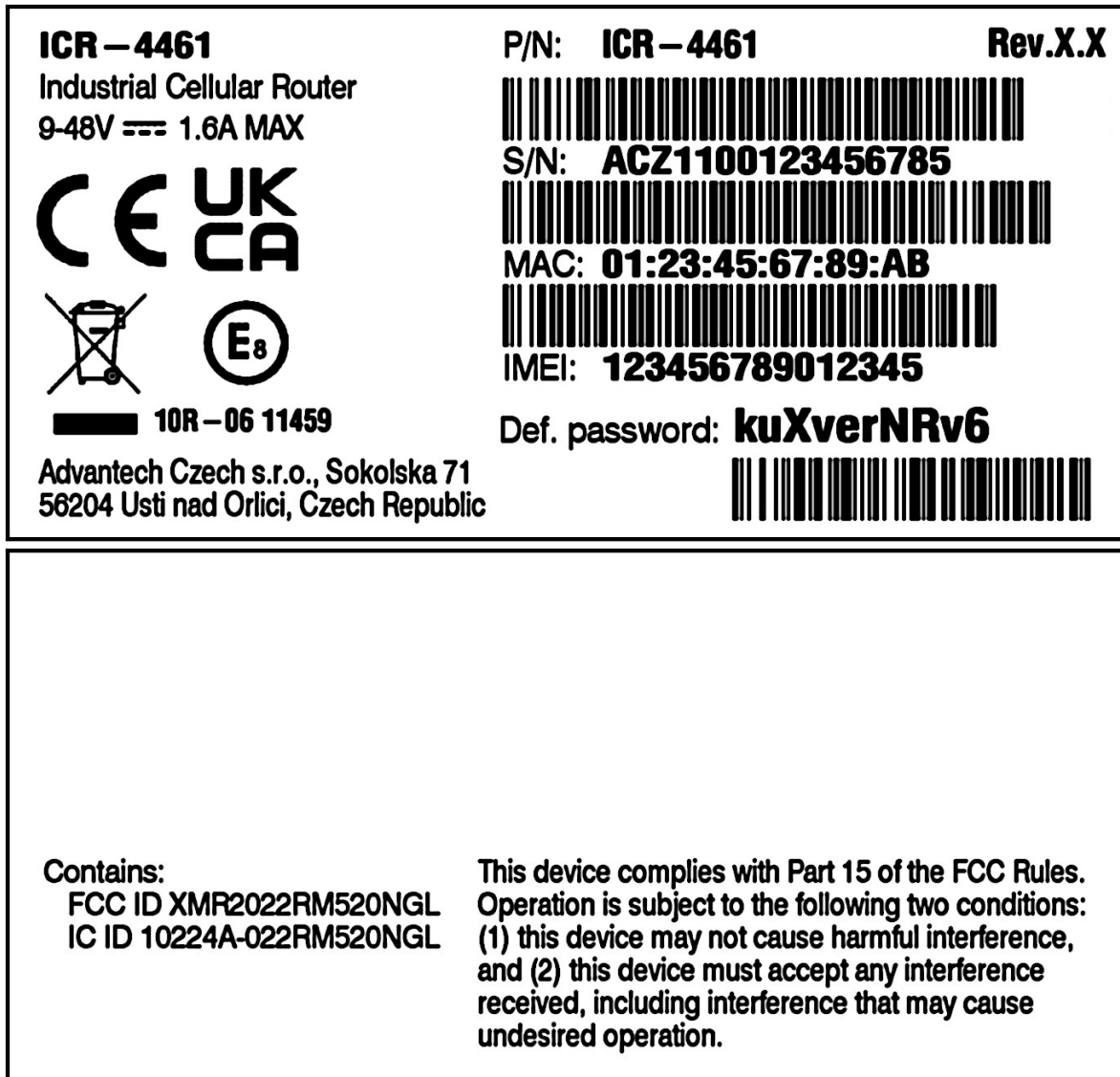

Figure 12: Product Label

2. Hardware Functionality

See Chapter 1.3 for an overview of the product's hardware, along with links to chapters offering detailed explanations.

2.1 SIM Card Slots

Slots for two SIM cards are located on the router beneath a metal cover. If you plan to use this device for cellular network communication, insert an activated data-provisioned SIM card into the SIM card slot.

You have the option to install two SIM cards simultaneously for utilizing the switching feature. The SIM cards can have different Access Point Names (APNs) configured. The procedure for changing SIM cards is outlined below. If the SIM requires a PIN, input it in the router's web interface (*Administration* → *Unlock SIM Card*).

 Type of SIM card: Mini SIM (2FF) 25.0 × 15.0 × 0.76 mm.

Inserting the SIM card:

- Always disconnect the router from the power supply before handling the SIM card.
- Unscrew the two screws on the SIM card cover and remove the cover.
- To remove an inserted SIM card, use the flat end of a spudger or your fingernail to press the SIM card slightly into its slot until you hear a click. Upon hearing the click, release the card, and it will pop out of its slot.
- To insert a SIM card, push the card into the slot until it clicks into place.
- Put the cover back and secure it with the two screws.

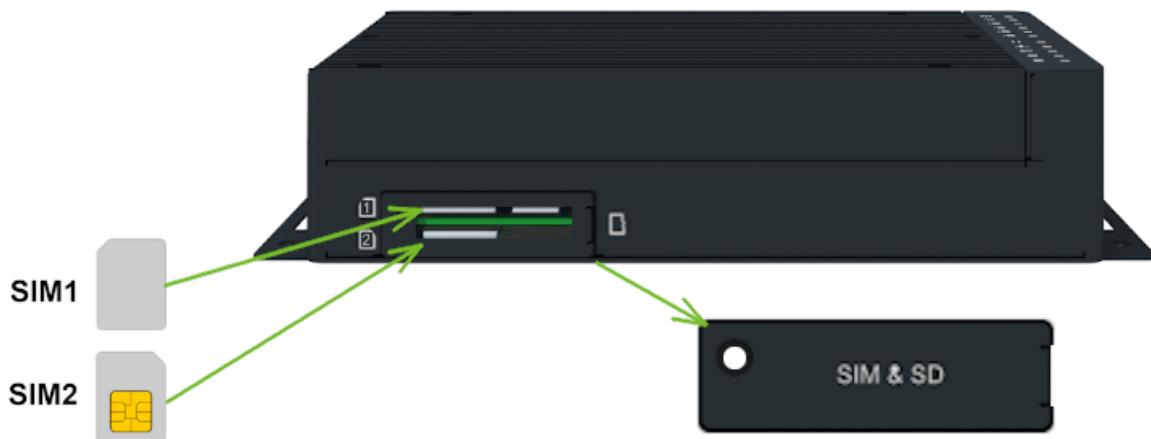

Figure 13: SIM Cards Insertion

2.2 Antennas Interfaces

SMA female connectors (*ANT0*, *ANT1*, *ANT2*, and *ANT3*) are intended for connecting cellular antennas to the router. See Table 20 for module antenna mapping. The GNSS antenna's SMA female connectors are shared with the cellular connectors and can be connected to the *ANT3* for the L1 band and to the *ANT1* for the L5 band. In addition, RP-SMA female connectors *WIFI1* are available for connecting the WiFi antennas.



Do not run the router without connected cellular antennas as the energy from the transmission is effectively reflected by the open end and can damage the equipment.



Recommended tightening moment for screwing the antenna to the SMA connector is 0.9 Nm.

2.3 Bluetooth

The WiFi connector, situated on the right-hand side of the device, is engineered for compatibility with Bluetooth antennas. For detailed information on the Bluetooth specifications supported by our router, please refer to Chapter 4.7. The integration of Bluetooth functionality within our router encompasses three principal components:

1. **Kernel Support and Drivers:** Integrated into the router's firmware, this includes kernel-level Bluetooth support and the necessary drivers to facilitate Bluetooth connectivity.
2. **Bluetooth Router App:** This application leverages the *BlueZ* Linux Bluetooth stack to extend the router's Bluetooth functionalities. It is not pre-installed on the router. For activation, the *Bluetooth Router App* must be downloaded and installed.
3. **Node-RED Applications:** To achieve advanced Bluetooth functionalities, Node-RED and its Bluetooth node can be employed. Similar to the Bluetooth Router App, *Node-RED* and the *Node-RED Bluetooth* node are available for installation.

2.4 Ethernet Interfaces

The RJ45 panel socket is used for four ETH0 (switched) and one ETH1 Ethernet interfaces. The pinout of the socket is shown in Figure 16 and described in Table 5.

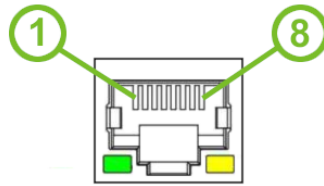

Figure 14: Ethernet Connector Pinout of RJ45 Socket



Pin	10base-T & 100base-T	1000base-T	PoE PSE (Mode B)
1	Tx+ (Transmit Data+)	BI_DA+ (BiDirectional pair A+)	—
2	Tx- (Transmit Data-)	BI_DA- (BiDirectional pair A-)	—
3	Rx+ (Receive Data+)	BI_DB+ (BiDirectional pair B+)	—
4	—	BI_DC+ (BiDirectional pair C+)	PoE PSE+ (positive pole)
5	—	BI_DC- (BiDirectional pair C-)	PoE PSE+ (positive pole)
6	Rx- (Receive Data-)	BI_DB- (BiDirectional pair B-)	—
7	—	BI_DD+ (BiDirectional pair D+)	PoE PSE- (negative pole)
8	—	BI_DD- (BiDirectional pair D-)	PoE PSE- (negative pole)

Table 5: Ethernet Connector Pinout Description of RJ45 Socket

i All four ETH0 ports can be used for **PoE PSE** if the router is equipped with this feature. For more information about the PoE, see Chapter 2.5; for technical parameters, see Chapter 4.10.

i The isolation barrier of the Ethernet ports against the ground is 1500 V.

2.5 Power over Ethernet (PoE) PSE

-  Available only for models with the PoE PSE feature; see Chapter 1.4 for the order codes.
-  The router supports the *IEEE 802.3af/PoE* (Type 1) and *IEEE 802.3at/PoE+* (Type 2) standards and is Mode B compliant.
-  To control the PoE functionality, you can use the `pse` command. For detailed information, please refer to the [Commands and Scripts](#) application note.



Please note that the router's power supply must be 48 V DC to operate as the PoE PSE device.

The PoE PSE feature enables the router to provide power to other devices over the Ethernet socket. You can refer to the functional scheme in Figure 15.

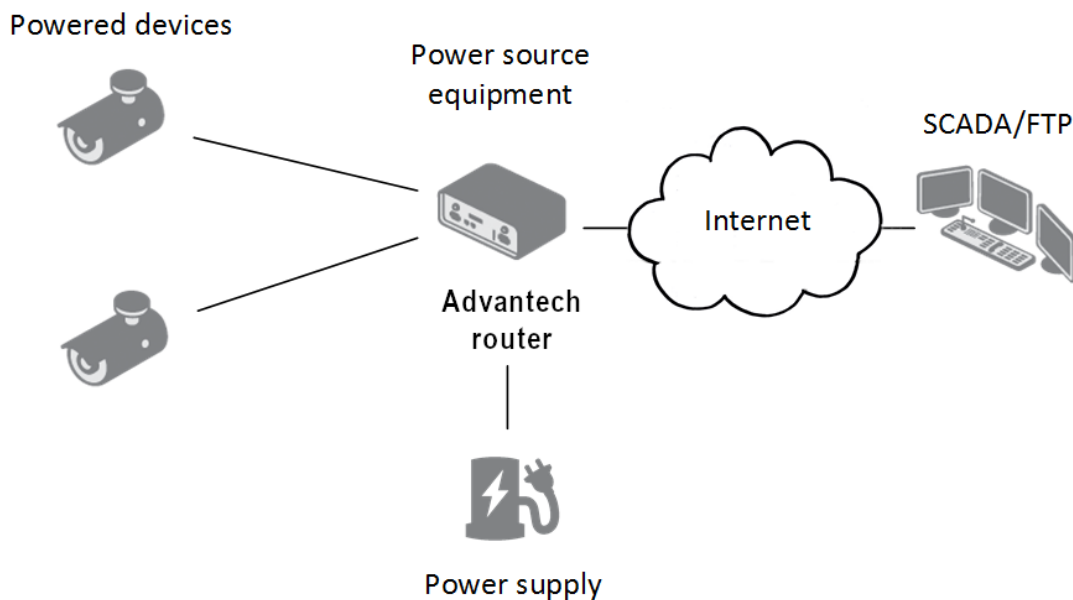

Figure 15: PoE PSE Funcional Scheme

The PoE PSE feature is supported by all four ETH0 network sockets and can be individually enabled in the *Ethernet* configuration pages. Detailed instructions can be found in the router configuration manual [1], specifically in Chapter *Configuration* → *Ethernet Configuration*. For information about the Ethernet socket pinout, please refer to Chapter 2.4.

To monitor the current PoE state, navigate to the *General* status page in the GUI. When PoE is enabled and an external device is being powered, you can access information about current, voltage, power, and power class here.

The following table summarizes the PoE parameters.

PoE PSE parameters	
Required power supply parameters	48 V / up to 135 W
Power available to a PoE device	12.95 W / per port
Required power supply wattage for a PoE device	15.40 W / per port
Power available to a PoE(+) device	25.50 W / per port
Required power supply wattage for a PoE(+) device	30.0 W / per port

Table 6: PoE PSE Parameters

PoE Power Budget Examples

Example #1

This example is for the Advantech [RPS-ICR4-WR2-PSE](#) power supply, which can supply a power of **65 W**. We will use 15 W as the maximum router power consumption; see Chapter [efchap:BasicParams](#). You can use this power supply to power:

- up to **three PoE devices** ($3 \times 15.4 \text{ W} + 15 \text{ W} = 61.2 \text{ W} < 65 \text{ W}$),
- just **one PoE+ device** ($1 \times 30 \text{ W} + 15 \text{ W} = 45 \text{ W} < 65 \text{ W}$).

Example #2

To power four PoE+ devices, you should use a power supply with a minimum rating of 135 W. You can calculate this as follows:

- Required power supply wattage = $4 \times 30 \text{ W} + 15 \text{ W} = 135 \text{ W}$.



Ensure that the power supply you use can provide enough power to cover the required power consumption of all connected PoE devices, including the router itself. We recommend using a power supply with some power reserve.

2.6 SFP Cage

A hot-pluggable (SFP) network interface module with a speed of up to 10 Gbps can be settled into the ETH2 SFP cage.

Installing an SFP Module

To install an SFP module, please refer to Figure 16 and follow these steps:

- If the SFP module is equipped with a bale clasp, ensure it is closed before inserting the SFP module.
- Hold the SFP module with the hardware label facing up.
- Gently insert the SFP module into the ETH2 slot and push it until it securely snaps into place.



Figure 16: SFP Module Installation

See Table 7 for a list of successfully tested SFP modules on the product.

Model	Manufacturer
SFP-GSM-20K	Advantech
ML-S+31Dout-10	MaxLink
S-3553LC20D	MikroTik
SFP-PLUS-LR10-HPE	Hewlett Packard
SFP-TXCIS	OEM
TXM431-LR(UN)	TP-Link
UF-RJ45-1G	Ubiquiti

Table 7: Tested SFP Modules

2.7 Power Supply

A two-pin terminal connector (pitch 3.5 mm) is utilized to power the router. The corresponding connector is included as a standard accessory with the router.

Pin	Signal mark	Description
1	VCC(+)	Positive pole of DC supply voltage (+9 to +48 V DC)
2	GND(-)	Negative pole of DC supply voltage

Table 8: Power connector pinout

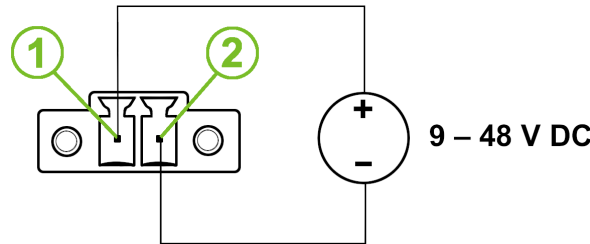

Figure 17: Power Connector Pinout

The required power supply voltage for the router ranges between +9 V and +48 V DC. Refer to the connection scheme in Figure 17 for proper setup. The router is equipped with built-in protection against reversed polarity, functioning without signaling. To guarantee correct operation, the power source must be capable of providing a sufficient amount of energy, as detailed in the consumption section of Chapter 4.1.



Grounding the router using the grounding screw eliminates the protection against reversed polarity. Ensure the negative pole of the DC power supply shares the same voltage reference as the grounding screw. A voltage difference between these points may damage the router, necessitating repairs exclusively by an authorized service center.



The power voltage for the PoE router version must be 48 V DC for it to function as a PoE PSE device.

All metal parts, including the box, are interconnected with the negative pole of the power supply (common pole). If recommended for the installation environment, protect the router by properly grounding it using the grounding screw, as depicted in Figure 18. The maximum tightening torque for the grounding screw is 1 Nm.



Figure 18: Position of the Grounding Screw

2.8 Low Power Mode



In applications requiring low power consumption, such as solar power (not 24/7 mode), it is strongly recommended to use the Low Power Mode (LPM) before shutting down the entire router.

LPM (Low Power Mode) is a router mode in which the router enters a sleep state with minimal power consumption; you can find details about LPM power consumption in Chapter [efchap:BasicParams](#). The router can be awakened from this mode either by applying a signal to the BIN1 input or after a predefined period of time. To put the router into LPM mode, you can use the `lpm` command; for more information, refer to the [Commands and Scripts](#) application note.

2.9 I/O Port Interfaces

The I/O user interface is designed for digital input processing and digital output control. The pinout of the I/O interface is described in Figure 19 and Table 9. For detailed electrical parameters see Chapter 4.8. The functional scheme of connection for the digital input and digital output is in Figure 20.

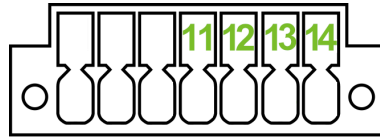

Figure 19: I/O Connector Pinout

Pin	Signal mark	Description
11	BIN0	The first digital input
12	BOUT0	The first digital output
13	BIN1	The second digital input
14	BOUT1	The second digital output

Table 9: Connection of I/O Ports

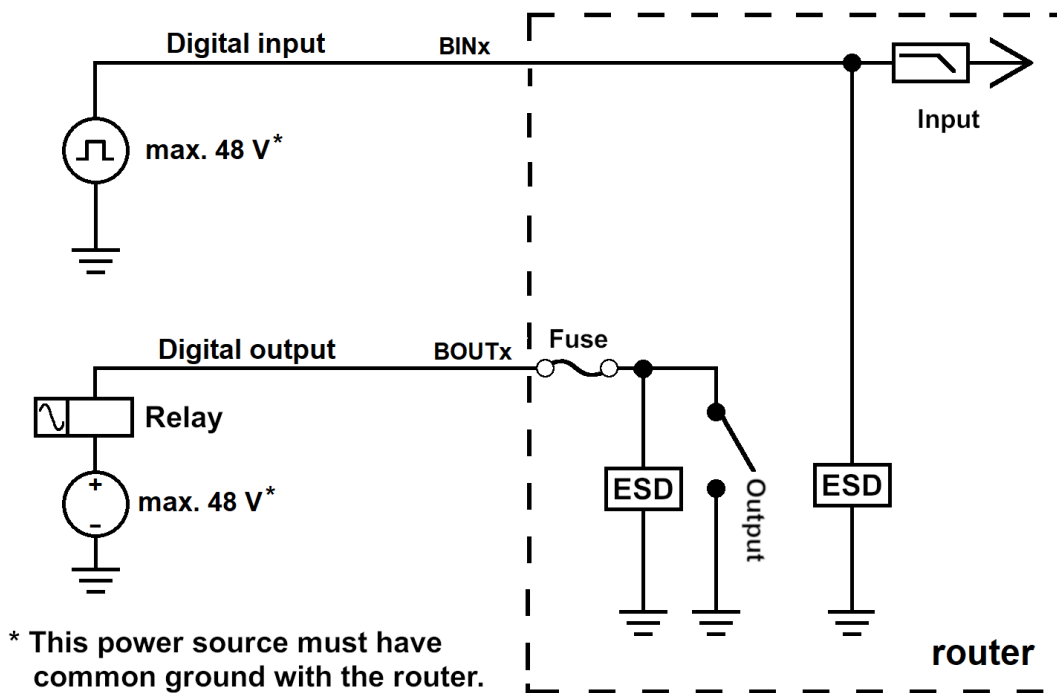

Figure 20: Functional Scheme of the Digital Interface

2.10 Serial Interfaces

The RS232, RS485 CAN serial interfaces together with the two I/O interfaces are physically connected to the 14-pin terminal block panel socket. All these interfaces are not isolated from the router. The pinout of this connector is described in Figure 21 and the tables below.

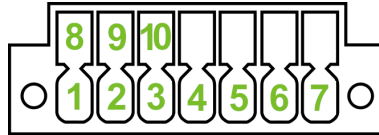

Figure 21: Serial Connector Pinout

Pin	Signal mark	Description
1	RXD	Received Data
2	CTS	Clear to Send
3	GND	Ground
4	RTS	Request to Send
5	TXD	Transmit Data

Table 10: Connection of RS232

Pin	Signal mark	Description
6	CAN_H	CAN High
7	CAN_L	CAN Low

Table 11: Connection of CAN Bus

Pin	Signal mark	Description
8	B (+)	In/Out
9	A (-)	In/Out
10	GND	Ground

Table 12: Connection of RS485

2.11 USB Port

The router features one USB 3.0 host port equipped with a USB-A type socket, supporting USB Mass Storage devices and serial converters. For guidance on integrating an unsupported chip, please consult the [Commands and Scripts](#) application note, with particular attention to the chapter titled *How to Use an Unsupported Serial Converter Chip*.

 The USB port is automatically disabled to prevent damage during an overload condition, which occurs when a connected device draws excessive current. Normal operation is restored after rebooting the router.

Mounting USB Flash Drive to the System

To access a USB flash drive from within the router's system, it must first be mounted. Follow the steps below:

- Execute the `dmesg` command to display the list of recently connected devices.
- Identify the USB flash drive in the output of the command, typically noted as:
`sda: sda1`
- Use the `mount` command to attach the drive to the `mnt` directory:
`mount /dev/sda1 /mnt`

 For detailed instructions on commands for creating, mounting, checking, and unmounting a file system on a USB Flash Drive, refer to the application note for the [Ext4 Filesystem Utilities](#) router app.

USB Socket Pinouts

The pinout details for the USB socket are illustrated in Figure 22 and further described in Table 13.

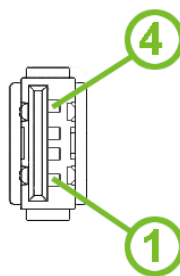

Figure 22: USB Connector Pinout

Pin	Signal mark	Description	Data flow direction
1	+5 V	Positive pole of 5 V DC supply voltage, 0.5 A	
2	USB data -	USB data signal – negative pole	Input/Output
3	USB data +	USB data signal – positive pole	Input/Output
4	GND	Negative pole of DC supply voltage	

Table 13: USB Connector Pinout

2.12 MicroSD Card Reader

The microSD card reader is located under the SIM cover on the router. This card reader enables the router to utilize microSD memory cards. The technical specifications are presented in Table 14.

Technical specifications of microSD card		
Supported technologies		SD, SDHC, SDXC
Supported capacity	SDHC	up to 32 GB
	SDXC	from 32 GB to 512 GB
Supported microSD card filesystems		vfat, ext2, ext3, ext4

Table 14: Technical Specifications of MicroSD Card

Inserting the microSD card:

- To remove an inserted microSD card, use the flat end of a spudger, or your fingernail, and press the card slightly into its slot until you hear a click. Release the card, and it will pop out of its slot.
- To insert a microSD card, push the card into the slot with the correct orientation as shown in the picture until it clicks into place.

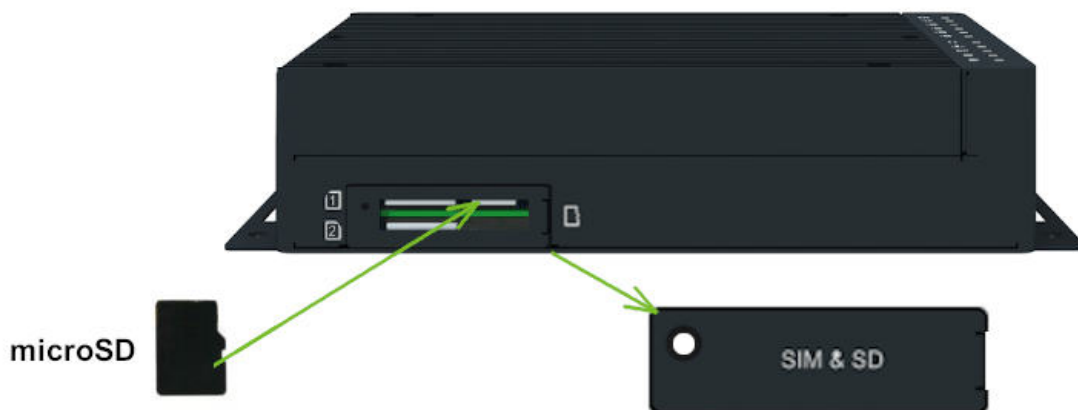

Figure 23: MicroSD Card Insertion

Mounting microSD Card to the System

To access the microSD card within the router's system, it must be mounted. Follow these steps to mount the card:

- Use the `dmesg` command to view the list of recently connected devices.
- Identify the entry for the microSD card in the command's output, for example:
`mmcblk0: p1`
- To mount the card to the `mnt` directory, use the `mount` command:
`mount /dev/mmcblk0p1 /mnt`



For more information about the commands for creating, mounting, checking, and unmounting a file system on a microSD card, refer to the application note for the [Ext4 Filesystem Utilities](#) router app.

2.13 LED Status Indication

There are status LEDs on the top side of the router to provide router status information. Moreover, ETH0 and ETH1 connectors, located on the front panel, have two additional LEDs providing information about the port status.













	Caption	Color	State	Description
	PWR	Green Green Green	On Blinking Fast blinking	The router is booting up. The router booted up and is ready. The router firmware is being updated.
	USR	Green	—	The function of this LED is user-defined.
	IN0	Green	On	The first digital input is active.
	IN1	Green	On	The second digital input is active.
	OUT0	Green	On	The first digital output is active.
	OUT1	Green	On	The second digital output is active.
	DAT	Green	Blinking	Cellular communication is in progress.
	SIG	Green Orange Red	On On On	Good cellular signal. Fair cellular signal. Poor cellular signal.
	TECH	Green Orange	On On	The active SIM uses 4G technology. The active SIM uses 3G technology.
	SIM1	Green Red	On Fast blinking	SIM1 is active for the cellular connection. A SIM1 issue (missing card or PIN not entered).
	SIM2	Green Red	On Fast blinking	SIM2 is active for the cellular connection. A SIM2 issue (missing card or PIN not entered).
	ETH0 ETH1	Green Green	On Off	Selected 1 Gbps bit rate. Selected 100/10 Mbps bit rate.
	ETH0 ETH1	Yellow Yellow Yellow	On Brief off blinks Off	The network cable is connected. Data transmission. The network cable is not connected.

Table 15: LED Status Indication

2.14 Reset Functions

The RST button has multiple functions depending on the firmware platform. For more information, see the configuration manual [1], chapter *Manual Introduction* → *Device* → *Reset*.

 Use a narrow screwdriver or any small tool to press the *RST* button.



Figure 24: Resetting the Router

3. First Use

3.1 Accessories Connection

Before putting the router into operation, make sure to connect all the components required for running your applications. Refer to Chapter 1.3 for an overview of the hardware. Also, remember to insert a SIM card for the cellular connection as explained in Chapter 2.1.



Ensure you do not operate the router without an antenna connected to the main antenna connector. Transmitting energy is effectively reflected by the open end, which could potentially damage the equipment.

3.2 Router Configuration

You can perform the initial configuration of the router using a web browser on your PC. This interface allows for router monitoring, configuration, and administration.

Begin by connecting the power supply to the router (refer to Chapter 2.7). The router will initiate its boot process. By default, the router will automatically establish a connection to the default Access Point Name (APN) of the inserted SIM card. Ensure your PC is configured to obtain IP settings automatically from the network. Connect your PC's network card to the default LAN interface of the router, Ethernet port ETH0. The DHCP server will assign an IP address to your PC.

To access the router's web interface, enter the following address in your web browser: <https://192.168.1.1>. Please note that using the HTTPS protocol for secure communication over the network is mandatory. The default user is `root`. Check the **product label** on the router for the **default password**. The user will be prompted to **change their password** when logging into the new router for the **first time**.



Consult the router **Configuration Manual [1]** for detailed descriptions and examples of router configuration.



For security reasons, we recommend regularly updating the router's firmware to the latest version. Downgrading the firmware to an older version than the production version or uploading firmware intended for a different device may cause the device to malfunction.



All routers have the *WebAccess/DMP* client pre-installed by default. The activated client periodically uploads router identifiers and configuration to the *WebAccess/DMP* server. See the configuration manual [1], chapter *Basic Information* → *WebAccess/DMP Configuration*, for more information.

4. Technical Parameters

4.1 Basic Parameters

Parameter		Description
Temperature range	Operating Storage	-40 °C to +75 °C (-40 °F to +167 °F) -40 °C to +85 °C (-40 °F to +185 °F)
Humidity	Operating Storage	5 to 95 % relative humidity non condensing 5 to 95 % relative humidity non condensing
Altitude	Operating	2000 m / 70 kPa
Degree of protection		IP30
Supply voltage		9 – 48 V DC
Battery for RTC		CR1225
Consumption for non-WiFi / WiFi version	Idle Average Maximum LPM mode	5.6 W / 6.5 W 6.5 W / 8.8 W 10.9 W / 14.2 W (142 W) ¹ 3 mW (170 mW) ²
Dimensions of device (w/o clips)		195 × 110 × 47 mm (7.68" × 4.33" × 1.85")
DIN rail clip specification		2 pcs of DIN 35 mm, EN 60715
Total weight		1275 g (2.81 lbs)

Table 16: Basic Parameters

¹Maximal power consumption for model with the PoE PSE (for maximal power load on all ETH0 ports).

²For device equipped with the PoE PSE.

4.2 Standards and Regulations

Parameter	Description
Radio	EN 301 908-1, EN 301 908-2, EN 301 908-13, EN 301 908-25, EN 303 413, EN 301 893, EN 300 328, FCC part 22H, FCC part 24E, FCC part 27, FCC part 90R, PTCRB
EMC	ETSI EN 301 489-1, ETSI EN 301 489-17, ETSI EN 301 489-19, ETSI EN 301 489-52, FCC Part 15.B, IEC 61000-6-2, IEC 61000-6-3, EN 55032, EN 61000-4-2, EN IEC 61000-4-3, EN 61000-4-4, EN 61000-4-5, EN 61000-4-6, EN IEC 61000-4-11
Safety	EN 62368-1, IEEE 802.3, EN IEC 62311
Carrier approvals	FirstNet ¹ , AT&T, Verizon ² , T-Mobile ²
Mechanical	EN 60068-2-27, EN 60068-2-64, MIL-STD-810G, SAE J1455, EN 60529
Climatic	EN 60068-2-1, EN 60068-2-2, EN 60068-2-14, MIL-STD-810G, SAE J1455
Transportation	E-Mark (E8), homologation number: 10R - 06 11459
National	CE, UKCA, FCC, IC compliant
Environmental	REACH, RoHS3 and WEEE compliant

Table 17: Standards and Regulations

¹Dedicated models only.

²Certification is issued for a specific project only.

4.3 Type Tests and Environmental Conditions

Phenomena	Test	Description	Test levels
ESD	EN 61000-4-2	Enclosure contact	± 6 kV (crit. A)
RF field AM modulated	EN 61000-4-3	Enclosure	20 V/m (crit. A) (80 – 1000 MHz) 10 V/m (crit. A) (1 – 6 GHz)
Fast transient	EN 61000-4-4	Signal ports Power ports Ethernet ports	± 1 kV (crit. A) ± 2 kV (crit. A) ± 1 kV (crit. A)
Surge	EN 61000-4-5	Ethernet ports Power ports	± 1 kV (crit. A), shielded cab. ± 1 kV (crit. A)
RF conducted	EN 61000-4-6	All ports	10 V/m (crit. A) (0.15 – 80 MHz)
Radiated emission	EN 55032	Enclosure	Class B
Conducted emission	EN 55032	Signal ports Power ports Ethernet ports	Class B Class B Class B
Dry heat	EN 60068-2-2	Test Bb, storage +85 °C, operation +75 °C	
Cold	EN 60068-2-1	Test Ab, storage -40 °C, operation -40 °C	
Damp heat	EN 60068-2-78	95 % rel. humidity (+40 °C)	
Dry heat, cyclic	EN 60068-2-30	+55 °C / +25 °C, rel. humidity 95 %, 12 h - 12 h	
Dry heat	EN 60068-2-2	Test Bb, storage +85 °C, operation +75 °C	
Thermal shock/ temp. variation	EN 60068-2-14	Test Nb, -40 °C/+75 °C, 3h/3h, 2 cycles, 3 K/min	
Degrees of protection provided by enclosures	EN 60529	IP30	
Vibration, broadband random	EN 60068-2-64	Spectrum A.3 cat 1, breakpoints A.6 cat 1	
Shock	EN 60068-2-27	50 m/s ² , 11 ms, half sine, 10 in each dir.	

Table 18: Type Tests and Environmental Conditions

4.4 Parameters of Cellular Module

Parameter	Description
Antenna	<ul style="list-style-type: none"> • Connector type: SMA (4 pcs) • Input impedance: 50 Ω • VSWR: ≤ 3 • Efficiency: $> 30\%$
5G NR parameters	<ul style="list-style-type: none"> • 3GPP Release 16 • Supported modulations: $\pi/2$-BPSK, QPSK, 16QAM, 64QAM and 256QAM for uplink; QPSK, 16QAM, 64QAM and 256QAM for downlink • UL 2 x 2 MIMO: n38, n41, n48, n77, n78, n79 • DL 4 x 4 MIMO 5G NR SA: n1, n2, n3, n7, n25, n30, n38, n40, n41, n48, n66, n70, n77, n78, n79 • DL 4 x 4 MIMO 5G NR NSA: n1, n2, n3, n7, n25, n30, n66, n38, n40, n41, n48, n70, n77, n78, n79 • Supporting SCS 15 kHz¹ and 30 kHz¹ • SA² and NSA² operation modes on all the 5G bands • Option 3x, 3a, and Option 2 • Supported 5G NR SA & NSA bands: n1 (2100), n2 (1900 PCS), n3 (1800), n5 (850), n7 (2600), n8 (900), n12 (700 a), n13 (700 c), n14 (700 PS), n18 (800 Lower), n20 (800), n25 (1900+), n26 (850+), n28 (700 APT), n29 (700 d), n30 (2300 WCS), n38 (TD 2600), n40 (TD 2300), n41 (TD 2600+), n48 (TD 3600), n66 (AWS), n70 (AWS-4), n71 (600), n75 (DL 1500+), n76 (DL 1500-), n77 (TD 3700), n78 (TD 3500), n79 (TD 4700) • NSA TDD: max. 3.4 Gbps(DL), max. 550 Mbps (UL) • SA TDD: max. 2.4 Gbps(DL), max. 900 Mbps (UL) • Max. output power: 5G NR bands: 23 dBm ± 2 dB (Class 3) 5G NR HPUE bands (n38/n40/n41/n77/n78/n79): 26 dBm $+2/-3$ dB (Class 2)

Continued on next page

¹5G NR FDD bands only support 15 kHz SCS, and NR TDD bands only support 30 kHz SCS.

²Supported bandwidth in the NSA and SA modes may differ for each frequency band.

Continued from previous page

Parameter	Description
LTE parameters	<ul style="list-style-type: none"> • 3GPP Release 16 (DL Cat 19 / UL Cat 18) • Supported modulations: QPSK, 16QAM, 64QAM and 256QAM (uplink/downlink) • 4 x 4 MIMO downlink for B1, B2, B3, B4, B7, B25, B30, B38, B40, B41, B42, B43, B48, B66 • Supported FDD bands: B1 (2100), B2 (1900 PCS), B3 (1800+), B4 (AWS-1), B5 (850), B7 (2600), B8 (900 GSM), B12 (700 a), B13 (700 c), B14 (700 PS), B17 (700 b), B18 (800 Lower), B19 (800 Upper), B20 (800 DD), B25 (1900+), B26 (850+), B28 (700 APT), B29 (700 d), B30 (2300 WCS), B32 (1500 L-band), B66 (AWS), B71 (600) • Supported TDD bands: B34 (TD 2000), B38 (TD 2600), B39 (TD 1900+), B40 (TD 2300), B41 (TD 2500+), B42 (TD 3500), B43 (TD 3700), B46 (TD Unlicensed), B48 (TD 3600) • Bandwidth: 1.4, 3, 5, 10, 15 and 20 MHz RF bandwidth • Bit rates: max. 1.6 Gbps (DL), max. 200 Mbps (UL) • Max. output power: LTE bands: 23 dBm \pm2 dB (Class 3) LTE HPUE (for single carrier) bands (B38/B41/B42/B43): 26 dBm \pm2 dB (Class 2)
UMTS parameters	<ul style="list-style-type: none"> • 3GPP Release 9, DC-HSDPA, HSPA+, HSDPA, HSUPA and WCDMA • Supported modulations: QPSK, 16QAM and 64QAM • Supported bands: B19 (800 MHz), B5 (850 MHz), B8 (900 MHz), B4 (AWS A-F 1700 MHz), B2 (PCS A-F 1900 MHz), B1 (2100 MHz) • DC-HSDPA: max. 42 Mbps (DL) • HSUPA: max. 5.76 Mbps (DL) • WCDMA: 384 kbps (DL) / 384 kbps (UL) • Max. output power: 24 dBm +1/-3 dB (Class 3)

Table 19: Technical Parameters of Cellular Module

4.4.1 Antenna Mapping

SMA	Description
ANT0	Antenna 0 interface: 5G NR: <ul style="list-style-type: none"> • Refarmed: LB_TX0/PRX & MHB_TX0/PRX & UHB_TX1/DRX • n41_TX0/PRX • n77/n78/n79_TX1/DRX LTE: LB_TX0/PRX & MHB_TX0/PRX & UHB_TX1/DRX WCDMA: LMB_TRX
ANT1	Antenna 1 interface: 5G NR: <ul style="list-style-type: none"> • Refarmed: MHB_PRX MIMO & UHB_PRX MIMO • n41_PRX MIMO • n77/n78/n79_PRX MIMO LTE: MHB_PRX MIMO & UHB_PRX MIMO & LAA_PRX GNSS: L5
ANT2	Antenna 2 interface: 5G NR: <ul style="list-style-type: none"> • Refarmed: MHB_TX1¹/DRX MIMO & UHB_TX0/PRX • n41_TX1/DRX MIMO • n77/n78/n79_TX0/PRX LTE: MHB_TX1 ¹ /DRX MIMO & UHB_TX0/PRX
ANT3	Antenna 3 interface: 5G NR: <ul style="list-style-type: none"> • Refarmed: LB_TX1/DRX & MHB_DRX & UHB_DRX MIMO • n41_DRX • n77/n78/n79_DRX MIMO LTE: LB_TX1/DRX & MHB_DRX & UHB_DRX MIMO & LAA_DRX WCDMA: LMB_DRX GNSS: L1

Table 20: Cellular Module Antenna Mapping

¹MHB TX1 will be active when supporting Sub 2.6 GHz EN-DC.

4.5 Parameters of GNSS

Parameter	Description
GNSS Systems	GPS, GLONASS, BDS, Galileo, QZSS
Antenna	Connector type: SMA Input impedance: 50 Ω Antenna connection: <ul style="list-style-type: none"> • shared with cellular SMA connectors • ANT3 for L1 band • ANT1 for L5 band Frequency range: <ul style="list-style-type: none"> • L1: 1559–1609 MHz • L5: 1166–1187 MHz Polarization: RHCP or linear VSWR: < 2 (Typ.) Power mode: pasive antenna only Passive antenna gain: > 0 dBi
Features	Protocol: NMEA 0183 Data update rate: 1 Hz
Frequency	GPS/Galileo/QZSS (L1): 1575.42 \pm 1.023 MHz GPS/Galileo/QZSS (L5): 1176.45 \pm 10.23 MHz Galileo (E1): 1575.42 \pm 2.046 MHz QZSS (L1): 1575.42 MHz GLONASS: 1597.5–1605.8 MHz BDS 1561.098 \pm 2.046 MHz
Sensitivity (autonomous)	Acquisition: -147 dBm Reacquisition: -160 dBm Tracking: -160 dBm
TTF (autonomous)	Cold start: 27.93 s Warm start: 11.55 s Hot start: 1.09 s
Accuracy (CEP-50) (autonomous)	1.35 m (at open sky)

Table 21: Technical Parameters of GNSS

4.6 Parameters of WiFi

Parameter	Description
Supported Standards	IEEE 802.11ac/a/b/g/n (2T2R)
Antenna Connectors	2x2 MIMO RP-SMA Input impedance: 50 Ω
Data Rate	802.11b: 11 Mbps 802.11a/g: 54 Mbps 802.11n: up to 300 Mbps (MCS0~15) 802.11ac: up to 867 Mbps (MCS0~9)
Frequency Ranges	2.412 – 2.484 GHz 5.150 – 5.850 GHz
Spectrum Widths	20/40MHz @ 2.4GHz 20/40/80MHz @ 5GHz
Modulation	802.11b: DSSS (DBPSK, DQPSK, CCK) 802.11g: OFDM (BPSK, QPSK, 16-QAM, 64-QAM) 802.11n: OFDM (BPSK, QPSK, 16-QAM, 64-QAM) 802.11a: OFDM (BPSK, QPSK, 16-QAM, 64-QAM) 802.11ac: OFDM(BPSK,QPSK,16-QAM,64-QAM,256-QAM)
Type of Device	Access point (AP) Station (STA) Multi-role (AP & STA)
Security – Standards	WPA, WPA2, WPA3, 802.1X
Security – Encryption	WEP, TKIP, AES
Security – EAP Types	EAP-FAST, EAP-TLS, EAP-TTLS, PEAP-GTC, PEAP-MSCHAPv2, PEAP-TLS, LEAP
TX Power	Max. 18 dBm @ 2.4 GHz Max. 14 dBm @ 5 GHz

Table 22: Technical Parameters of WiFi

4.7 Parameters of Bluetooth

Parameter	Description
Bluetooth Standards	V5.0 , V4.2 , V4.1 LE , V3.0+HS , V2.1+EDR
Antenna	Shared with right RP-SMA connector
Frequency Range	2.412GHz 2.484GHz 5.150GHz 5.850GHz
Data Rates Supported	300 Mps @ 802.11n 867 Mps @802.11ac
Receive Sensitivity	3 Mbps: <0.1% BR,BER at -70dBm
Output Power	3 Mbps: +6 ≤ Output Power ≤ +10dBm

Table 23: Technical parameters of Bluetooth

4.8 Parameters of I/O Ports

Electrical characteristics of the digital input are in Table 24. Status of the digital input can be retrieved in the router's web interface (on the *General Status* page) or by the `status ports` and `io get` commands, see *Commands and Scripts* application note.

Logical ¹	Voltage	Current	Status ²
1	3 V	0.5 mA	Off
0	5 V	0.8 mA	On
0	12 V	1.6 mA	On
0	48 V	3.4 mA	On

Table 24: Electrical Characteristics of Digital Input

The maximum digital output load is **500 mA** at **48 V**.

¹The digital status returned by the `io get` shell command.

²The digital status returned by the `status ports` shell command and displayed on the *General Status* page.

4.9 Parameters of Serial Interfaces

Supported parameters of the RS232 and RS485 interfaces, which can be configured in *Expansion Port 1* resp. *Expansion Port 2* menu items, are in Table 25.

Parameter	Description
Baudrate	300, 600, 1200, 2400, 4800, 9600, 19200, 38400, 57600, 115200, 230400.
Data Bits	5, 6, 7, 8.
Parity	none, even, odd.
Stop Bits	1, 2.
Flow Control	none, hardware.

Table 25: Parameters of Serial Interfaces

4.10 Parameters of PoE

For more information about the PoE PSE feature, including the parameters, see Chapter 2.5.

4.11 System Configuration

The main parameters of the system are listed in Table 26.

Parameter	Description
CPU architecture	Quad-Core ARMv8-A (core Cortex-A72)
CPU frequency	1200 MHz
CPU power	4.72 DMIPS/MHz
Flash memory	4 MB of NOR 4 096 MB of eMMC <ul style="list-style-type: none"> • 838 MB for Router Apps • 512 MB for customer data • The remaining space is reserved for the system.
RAM size	1 024 MB
Watchdog	HW watchdog
RTC	Battery backup RTC
TPM	Trusted Platform Module (TPM) 2.0
SIM Slots	2× SIM (Mini SIM – 2FF) 1× Chip SIM (MFF2) ¹

Table 26: System Configuration

¹Not assembled by default, for dedicated customer orders only.

Appendix A: Troubleshooting

If you cannot connect to the router from your PC, your network card may be configured in such a way that it is not possible to connect to the router. Take one or more of the following steps in order to solve the problem:

- Make sure your PC's network card is configured to obtain the IP address from the DHCP server (by default the DHCP server is running in the router).
- Connect the router to the PC via Switch.
- Connect the router to the PC, start the router first and then start the PC after the router's initialization.

Ethernet connection fails or is not establishing.

- It is possible to turn auto negotiation off and set a rate and duplex manually on the Ethernet interface of the router. Available on "LAN Configuration" page in the router.

Mobile WAN connection fails.

- Check the signal power ("Mobile WAN status" page). If the signal power is weak, you will have to use a better antenna. If the neighbouring cells have a similar signal strength, you will need to use a directional antenna. For proper operation, the signal levels have to be good.
- Try to enable automatic ping from the router, which will check the connection when there are no data running and in the case of a failed ping, restart the connection. This can be done on the "Mobile WAN Configuration" page in the router in the "Check connection" section. "Enable + bind" option is to ensure the ping goes always through Mobile WAN network interface.

Mobile WAN connection cannot be established.

- Check the "Mobile WAN Configuration" – APN, name, password and IP address (all can be blank).
- Try to enter the SIM card PIN – verify that the SIM card has the PIN code entered. Available on "Unlock SIM Card" page in the "Administration" section.
- In a private APN it is not recommended to get the DNS settings from operator (on "Mobile WAN" page)
- Go to "System Log" page in "Status" section and observe where the error occurs.

I cannot connect from the Internet to the device behind the router. I have NAT enabled.

- The device's gateway has to be configured so it points to the router.

I can't access my Web server placed behind the router over NAT.

- The remote HTTP access to the router has to be disabled on "NAT Configuration" page in the router. Also enable "Send all remaining incoming packets to default server" feature and fill in the IP address of your Web server. On the Web server, the default gateway has to be the IP address of the router.

DynDNS doesn't work.

- With private APN this will not work.

- If the same IP address is recorded in your canonic name as a dynamically assigned address, it means that the operator is using NAT or a firewall.
- You can verify NAT using ping to your server with static address and then compare with router's IP address.
- You can verify a Firewall by accessing remotely to the router's Web interface.
- The operator may not provide the address of DNS server and without DNS server's address it is impossible to connect to the dyndns.org server. The following messages will be shown in the System Log:
 - DynDNS daemon started
 - Error resolving hostname: no such file or directory
 - Connect to DynDNS server failed

 **L2TP or IPSec isn't establishing.**

- Check the "System Log" page for error messages.

 **IPSec tunnel establishes but the communication does not run.**

- Probably there are bad routing rules defined in the connected devices, or the default gateway.

 **I switched the router to offline mode by SMS message, but the router is in online mode after reboot.**

- SMS messages do not change the router configuration. They remain in effect only until the router is rebooted.

Serial communication is not working.

- Verify that the router model supports serial communications. Also verify the serial communication settings. To do so, open the router's configuration menu via the web browser, select the appropriate "Expansion Port" from "Configuration" part of the menu and verify the settings.

Is the router Cisco compatible? Can I use the Cisco configuration?

- No, the Firmware in the router (ICR-OS) is based on Linux with BusyBox. Thus the Cisco configuration cannot be used. But network connections are defined by standards so connecting the router to the Cisco or other networking devices is possible and will be compatible.

FTP or SFTP does not work

- FTP will work on v2 routers only. You can use SFTP on all routers to transfer files to/from the router. If having troubles with FTP on v2 routers, make sure you have FTP enabled: "Configuration" section, "Services", "FTP". Then you can connect with any client on port 21 with name and password same as for the Web interface. If having troubles with SFTP, make sure you have SSH enabled: "Configuration" section, "Services", "SSH". Then you can connect with any client on port 22 with name and password same as for the Web interface.

How can I connect to the router's command line? (SSH, Telnet)

- You can use SSH on all routers or Telnet on v2 routers only. SSH is enabled by default, but you can verify in Web interface in "Configuration" section, "Services", "SSH". Then connect with any SSH client on port 22 of the router. User and password is the same as for the Web interface. Telnet on v2 routers can be enabled here: "Configuration" section, "Services", "Telnet".

Appendix B: Customer Support

Customer Support for Europe

Advantech Czech s.r.o.

Sokolska 71
562 04, Usti nad Orlici
Czech Republic

Phone: +353 91 792444
Fax: +353 91 792445
E-mail: iiotcustomerservice@advantech.eu
Web: www.advantech.com

Customer Support for NAM

Advantech B+B SmartWorx

707 Dayton Road
Ottawa, IL 61350 USA

Phone: +1-800-346-3119 (Monday – Friday, 7 a.m. to 5:30 p.m. CST)
Fax: +1-815-433-5109
E-mail: support.iiot.ana@advantech.com
Web: www.advantech.com

Customer Support for Asia

Phone: +886-2-2792-7818 #1299 (Monday – Friday, 9 a.m. to 5:30 p.m. UTC+8)
Fax: +886-2-2794-7327
E-mail: icg.support@advantech.com.tw
Web: www.advantech.com

Appendix C: Regulatory & Safety Information

Safety Notices



Please, observe the following instructions:

- The router must adhere to all relevant international and national laws, including any specific restrictions governing its use in designated applications and environments.
- To prevent potential injury and appliance damage, ensure compliance with regulations by using only authorized accessories. Unauthorized modifications or use of unapproved accessories could damage the router, violate regulations, and void the warranty.
- Do not attempt to open the router.
- Before handling the SIM card, turn off the router and disconnect it from the power supply.
- **Caution!** This equipment is not suitable for use in areas with children. Small children could swallow the SIM card.
- Ensure the power supply does not exceed 48 V DC maximum.
- Avoid exposing the router to extreme ambient conditions. Safeguard it against dust, moisture, and high temperatures.
- Only deploy routers with appropriate certification and labeling in environments containing flammable or explosive materials, such as gas stations, chemical plants, or areas involving explosives. Users must observe restrictions pertaining to radio device usage in such settings.
- When traveling by plane, switch off the router. Using it onboard could jeopardize flight operations, disrupt mobile networks, and potentially violate regulations. Non-compliance may result in telephone service suspension, cancellation, or legal repercussions.
- Exercise heightened caution when operating the router near personal medical devices like cardiac pacemakers or hearing aids.
- The router may cause interference when operated in close proximity to TV sets, radio receivers, or personal computers.
- It's advisable to create a suitable backup of all critical settings stored in the device's memory.



Product Disposal Instructions

The WEEE (Waste Electrical and Electronic Equipment: 2012/19/EU) directive was introduced to ensure that electrical/electronic products are recycled using the best available recovery techniques to minimize the environmental impact. This product contains high quality materials and components which can be recycled. At the end of its life this product **MUST NOT** be mixed with other commercial waste for disposal. The device contains a battery. Remove the battery from the device before disposal. The battery in the device needs to be disposed of apart accordingly. Check the terms and conditions of your supplier for disposal information.

Appendix D: Related Documents

[1] ICR-4400 Configuration Manual



[EP] Product-related documents and applications can be obtained on **Engineering Portal** at <https://icr.advantech.com/download> address.



We, Advantech Czech s.r.o., declare that the radio equipment narrated in this user's manual complies with Directive **2014/53/EU**.



We, Advantech Czech s.r.o., declare that the radio equipment narrated in this user's manual complies with Radio Equipment Regulations 2017 (**S.I. 2017 No. 1206**).

The full text of the EU Declaration of Conformity is available at the following internet address:
icr.advantech.com/eudoc