



Hardware Manual

Industrial Cellular Router

ICR-2441



© 2025 Advantech Czech s.r.o. No part of this publication may be reproduced or transmitted in any form or by any means, electronic or mechanical, including photography, recording, or any information storage and retrieval system without written consent. Information in this manual is subject to change without notice, and it does not represent a commitment on the part of Advantech.

Advantech Czech s.r.o. shall not be liable for incidental or consequential damages resulting from the furnishing, performance, or use of this manual.

All brand names used in this manual are the registered trademarks of their respective owners. The use of trademarks or other designations in this publication is for reference purposes only and does not constitute an endorsement by the trademark holder.

Used symbols



Danger – Information regarding user safety or potential damage to the router.



Attention – Problems that can arise in specific situations.



Information – Useful tips or information of special interest.



Contents

| | |
|--|-----------|
| 1. Product Overview | 1 |
| 1.1 Product Introduction | 1 |
| 1.2 Hardware Overview | 2 |
| 1.3 Order Codes | 4 |
| 1.4 Product Revisions | 4 |
| 1.5 Package Contents | 5 |
| 1.6 Product Dimensions | 6 |
| 1.7 Mounting Recommendations | 8 |
| 1.8 Wall Mounting | 9 |
| 1.9 DIN Rail Mounting | 10 |
| 1.10 Product Label | 11 |
| 2. Hardware Functionality | 12 |
| 2.1 SIM Card Slots | 12 |
| 2.2 Antennas | 13 |
| 2.3 Ethernet Interfaces | 13 |
| 2.4 Power Supply | 14 |
| 2.5 I/O Port Interfaces | 15 |
| 2.6 Serial Interfaces | 16 |
| 2.7 LED Status Indication | 17 |
| 2.8 Reset Functions | 18 |
| 3. First Use | 19 |
| 3.1 Accessories Connection | 19 |
| 3.2 Router Configuration | 19 |
| 4. Technical Specifications | 20 |
| 4.1 Basic Parameters | 20 |
| 4.2 Standards and Regulations | 21 |
| 4.3 Type Tests and Environmental Conditions | 22 |
| 4.4 Parameters of Cellular Module | 23 |
| 4.5 Parameters of GNSS | 23 |
| 4.6 Parameters of WiFi | 24 |
| 4.7 Parameters of I/O Ports | 25 |
| 4.8 Parameters of Serial Interfaces | 25 |
| 4.9 System Configuration | 26 |
| Appendix A: Troubleshooting | 27 |
| Appendix B: Customer Support | 30 |
| Appendix C: Regulatory & Safety Information | 31 |
| Appendix D: Related Documents | 32 |

List of Figures

| | | |
|----|---|----|
| 1 | Router Hardware Overview: Front View | 2 |
| 2 | Router Hardware Overview: Rear View | 3 |
| 3 | Router Dimensions – Top, Side and Front View with Wall Mount Clip | 6 |
| 4 | Router Dimensions – Top, Side and Front View with DIN Rail Clip | 7 |
| 5 | Screwed Wall Mounting Clip | 9 |
| 6 | Position of the DIN Rail Clip | 10 |
| 7 | Removing Router from the DIN Rail | 10 |
| 8 | Product Label | 11 |
| 9 | SIM Cards Insertion | 12 |
| 10 | Ethernet Connector Pinout | 13 |
| 11 | Connection of Power Supply | 14 |
| 12 | Position of the Grounding Screw | 14 |
| 13 | I/O Connector Pinout | 15 |
| 14 | Functional Scheme of the Digital Interface | 15 |
| 15 | RS485 and RS232 Pinout | 16 |
| 16 | Resetting the Router | 18 |

List of Tables

| | | |
|----|---|----|
| 1 | Router Hardware Overview: Front View | 2 |
| 2 | Router Hardware Overview: Rear View | 3 |
| 3 | Order Codes Overview | 4 |
| 4 | HW Revisions History | 4 |
| 5 | Contents of Package | 5 |
| 6 | Ethernet Connector Pinout Description | 13 |
| 7 | Power Supply Pinout | 14 |
| 8 | I/O Ports Pinout | 15 |
| 9 | Connection of RS485 | 16 |
| 10 | Connection of RS232 | 16 |
| 11 | LED Status Indication | 17 |
| 12 | Basic Parameters | 20 |
| 13 | Standards and Regulations | 21 |
| 14 | Type Tests and Environmental Conditions | 22 |
| 15 | Technical Parameters of Cellular Module | 23 |
| 16 | Technical parameters of GNSS | 23 |
| 17 | Technical Parameters of WiFi | 24 |
| 18 | Electrical Characteristics of Digital Input | 25 |
| 19 | Parameters of Serial Interfaces | 25 |
| 20 | System Configuration | 26 |

1. Product Overview

1.1 Product Introduction

Industrial cellular router ICR-2441 is designed for wireless communication in mobile networks that use traditional cellular technologies and is focused on the North American (NAM) market.

The primary purpose of this router is its use in the Category 4 (**Cat.4**) services on the cellular **LTE** network. Cat.4 rated router is capable of achieving typical speeds in 4G coverage areas where the network is enabled with 20 MHz of contiguous spectrum. The peak **downlink** data rate for Category 4 is approximately **150 Mbps**. In the **uplink**, LTE Category 4 provides a peak data rate of **50 Mbps**.

The router is equipped with two independently configurable **Ethernet ports**, **RS232** and **RS485** serial ports and with one **digital input** together with one **digital output**. The router can be equipped with a **dual-band WiFi module**, but this must be part of the initial configuration – it cannot be assembled to the router at some point in the future.

Router configuration is accessible through a **secure web interface**, offering detailed insights into the entire configuration, statuses, signal strength, and logs.

Basic features include **two-factor authentication**, **IPv6 Dual Stack**, **DHCP**, **NAT**, **NAT-T**, **DynDNS**, **DNS proxy**, **VLAN**, **QoS**, **NTP**, **VRRP**, **SMS control**, **port forwarding**, and **connection backup**, among others. The router supports various VPN protocols, including **IPSec**, **OpenVPN**, **GRE**, **L2TP**, and **PPTP**, ensuring secure communication.

The router allows for the insertion of **Linux scripts** for automated tasks. It supports the definition of up to **four distinct profiles**, switchable via the web interface, SMS, or digital input.

Router Apps enhance router functionality through custom software programs. For Advantech routers, a diverse array of Router Apps is offered, encompassing categories such as connectivity, routing, services, among others, freely accessible on the Advantech [Router Apps](#) webpage. Additionally, directly from the router web interface, you can use an **Advantech public server** for the Router App or router firmware installation/update.

Compatibility with Advantech's **remote device management** platform, [WebAccess/DMP](#), offers extensive device management and monitoring, ensuring that devices remain up-to-date and secure.

1.2 Hardware Overview

In this chapter, all components of the router case are described, including links to chapters that provide more details.

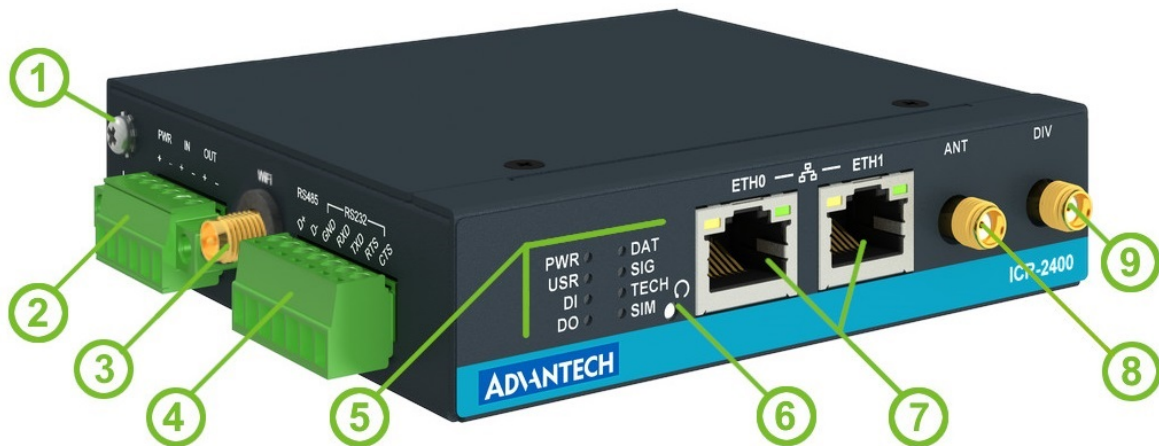

Figure 1: Router Hardware Overview – Front View

| # | Item/Caption | Type | Description |
|---|-----------------|----------------------------|---|
| 1 | Grounding screw | M3 | Pay attention to proper grounding; see Chapter 2.4. |
| 2 | PWR IN/OUT | 6-pin terminal | Power supply, digital input, and digital output interfaces. See Chapter 2.4, Chapter 2.5, Chapter 2.6 for more information, Chapter 4.7 for I/O parameters, and Chapter 4.8 for serial interface parameters . |
| 3 | AUX | RP-SMA female / SMA female | Connector for the WiFi/GNSS antenna; see Chapter 2.2, Chapter 4.6 for WiFi parameters and Chapter 4.5 for GNSS parameters. |
| 4 | RS485/RS232 | 7-pin terminal | RS232 & RS485 serial interfaces; see Chapter 2.6. |
| 5 | LEDs | - | Status LED indication; see Chapter 2.7. |
| 6 | RST | - | Button to reboot the router or to restore the default configuration; see Chapter 2.8. |
| 7 | ETH0 ETH1 | RJ45 RJ45 | 100 MB Ethernet connections for the first and second LAN; see Chapter 2.3. |
| 8 | ANT | SMA female | Connector for the main antenna of the cellular module; see Chapter 2.2. |
| 9 | DIV | SMA female | Connector for the second antenna of the cellular module (required for the MIMO DL); see Chapter 2.2. |

Table 1: Router Hardware Overview – Front View



Figure 2: Router Hardware Overview – Rear View

| # | Item/Caption | Type | Description |
|----|--------------|-----------|--|
| 10 | SIM slots | Micro SIM | Two SIM card slots; see Chapter 2.1. |
| 11 | DIN clip | - | DIN rail clip, not included as standard accessories; see Chapter 1.9. |
| 12 | Wall clip | - | Wall mounting clip, included as standard accessories; see Chapter 1.8. |

Table 2: Router Hardware Overview – Rear View

1.3 Order Codes

Order codes overview is shown in the table below.

| Order code | Features – interfaces |
|-------------------|---|
| ICR-2441 | LTE Cat.4 with 3G/2G fallback cellular module, 64 MB NOR Flash, 2x ETH, 1x RS232, 1x RS485, 1x Digital Input, 1x Digital Output, 2x SIM reader |
| ICR-2441 G | LTE Cat.4 with 3G/2G fallback cellular module, 64 MB NOR Flash, 2x ETH, 1x RS232, 1x RS485, 1x Digital Input, 1x Digital Output, 2x SIM reader, GNSS |
| ICR-2441 W | LTE Cat.4 with 3G/2G fallback cellular module, 64 MB NOR Flash, 2x ETH, 1x RS232, 1x RS485, 1x Digital Input, 1x Digital Output, 2x SIM reader, dual-band WiFi |

Table 3: Order Codes Overview

1.4 Product Revisions

For the product revision history of the entire product platform, refer to the table below. Please note that some revisions may not be available for certain order codes. The revision number is printed on both the packaging and product labels.

The router GUI can also display the product revision under *Status* → *General* → *System Information* → *Product Revision*. Please note that the default revision (Rev.1.0) is unavailable here.

| Rev.# | Description |
|-------|---|
| 1.0 | Initial version (revision number not printed on the labels). |
| 2.0 | New design of the mainboard; refer to PCN-2023-05 for details. |
| 2.1 | Changed the WiFi label on the chassis to "AUX"; refer to PCN-2024-05 for details. |

Table 4: HW Revisions History

1.5 Package Contents

The standard set of router includes items listed in the following table:





| Item# | Description | Figure | Q'ty |
|-------|--|--|-------|
| 1 | Router |  | 1 pcs |
| 2 | Wall mounting clip with screws |  | 1 set |
| 3 | 6-pin terminal block for power supply, digital input and digital output (deployed on the router) |  | 1 pcs |
| 4 | 7-pin terminal block for RS485 and RS232 (deployed on the router) |  | 1 pcs |
| 5 | Printed <i>Quick Start Guide Leaflet</i> |  | 1 pcs |

Table 5: Contents of Package

1.6 Product Dimensions

For the dimensions of the product see the figures below. Note that all sizes are measured in millimeters.

Variant with Wall Mounting Clip

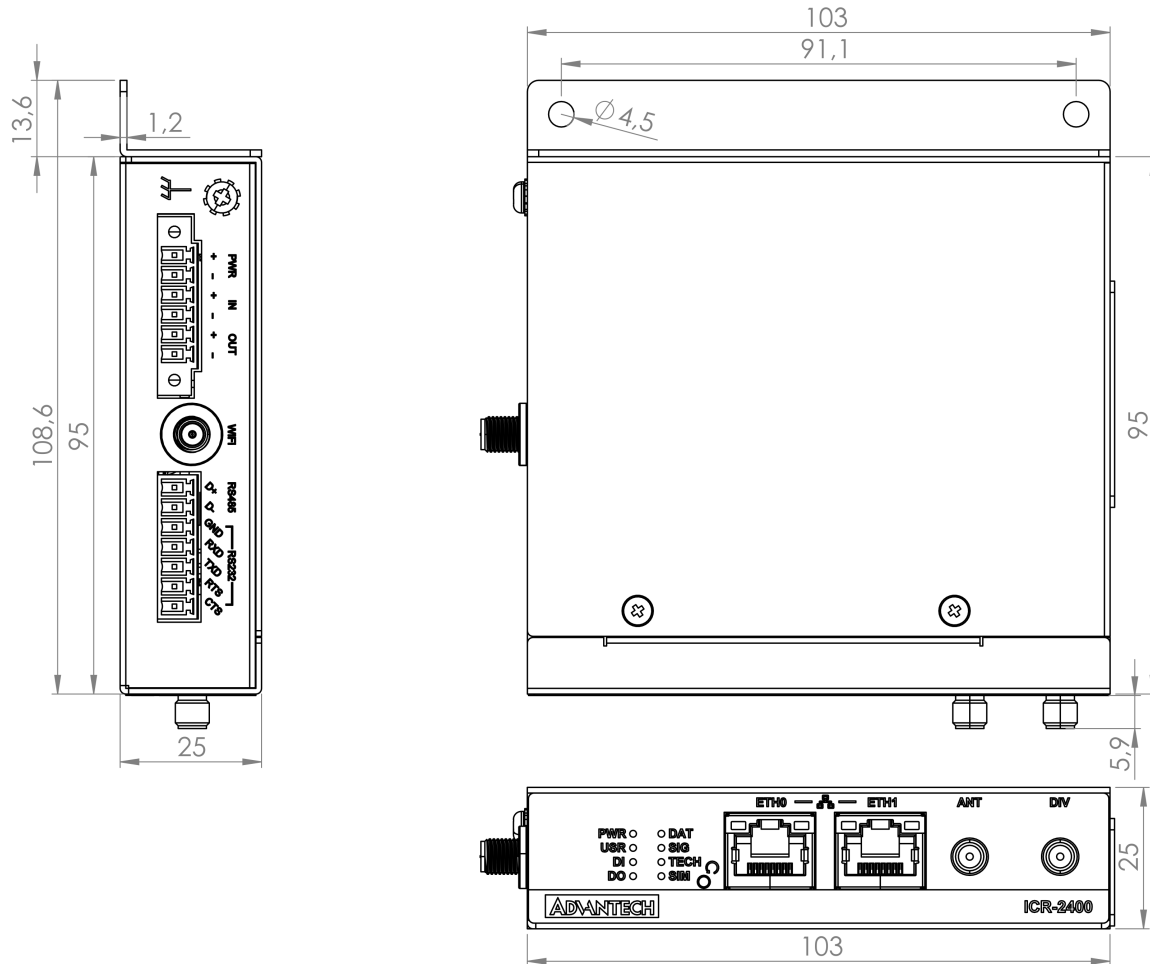

Figure 3: Router Dimensions – Top, Side and Front View with Wall Mount Clip

Variant with DIN Rail Clip

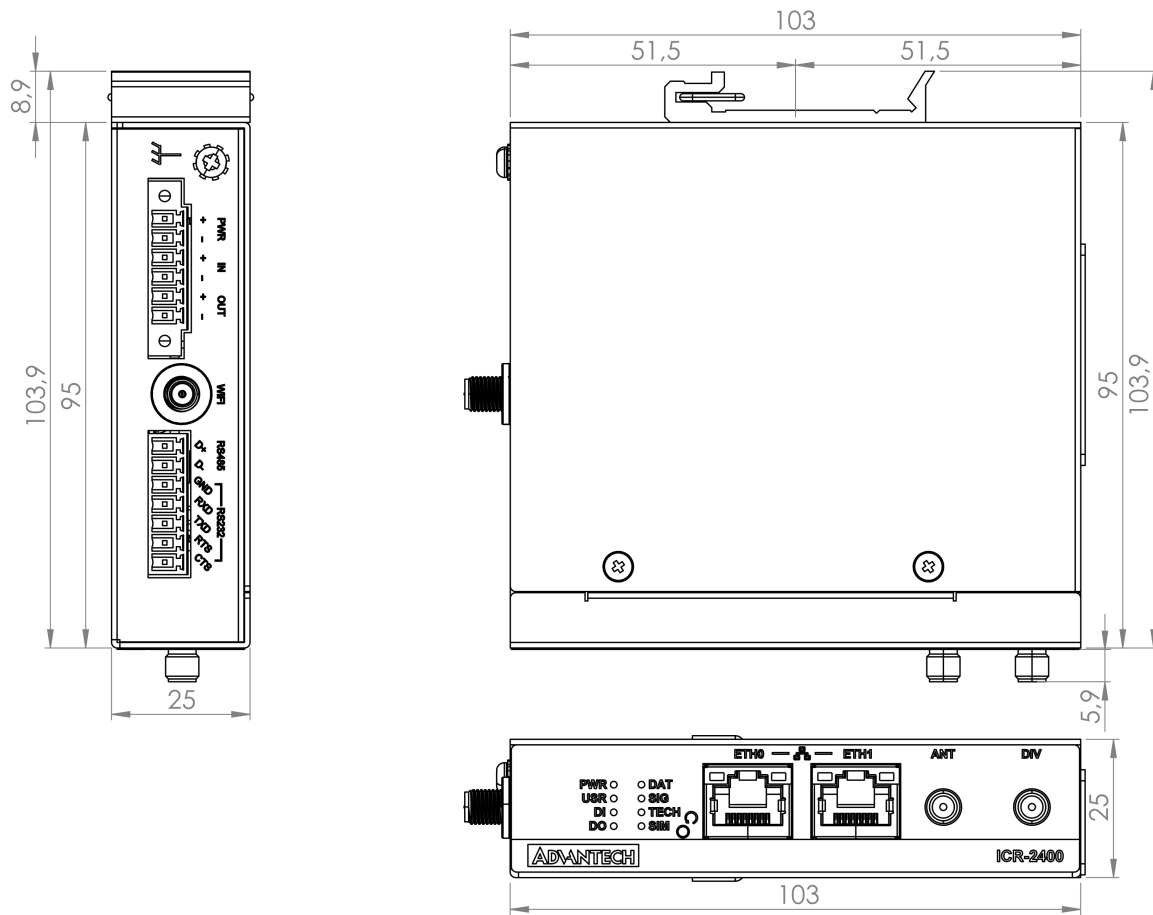

Figure 4: Router Dimensions – Top, Side and Front View with DIN Rail Clip

1.7 Mounting Recommendations

The router can be placed:

- on a flat surface,
- on a wall using the wall mounting clip (see Chapter 1.8),
- on a DIN rail EN 60715 with the metal DIN rail clip (see Chapter 1.9)

For most applications with a built-in router within a switchboard, it is possible to recognize two kinds of environments:

- A non-public, industry environment of low voltage with high interference,
- a public environment of low voltage and without high interference.

For both of these environments, it is possible to mount the router to a switchboard, after which there is no need to have examination immunity or issues in connection with EMC according to EN 61439-1:2011.



In compliance with the EN 61439-1:2011 specification, it is necessary to observe the following assembly instructions for a router attached to a switchboard:

- For whip antennas it is recommended to observe a minimum distance of 6 cm from cables and metal surfaces on every side in order to avoid interference. When using an external antenna separate from the switchboard it is necessary to fit a lightning conductor.
- When mounting a router on sheet-steel we recommend using a cable antenna.
- For all cables, we recommend to bind the bunch, and for this we recommend:
 - The length of the bunch (the combination of power supply and data cables) should be a maximum 1.5 m. If the length of data cables exceeds 1.5 m or if the cable is leading towards the switchboard, we recommend installing surge protectors.
 - Data cables must not have a reticular tension of ~ 230 V/50 Hz or ~ 120 V/60 Hz.
- Sufficient space must be left between each connector for the handling of cables,
- To ensure the correct functioning of the router we recommend the use of an earth-bonding distribution frame for the grounding of the grounding screw, see Chapter 2.4.

1.8 Wall Mounting

 The wall mounting clip is supplied with the router as standard accessories.

The router can be screwed to a wall (or another surface) using the wall mounting clip. There are two wholes on the clip with a diameter of 4 millimeters. For detailed information about the mounting dimensions see Figure 3 in Chapter 1.6.

 When mounting the wall mounting clip, tighten the screws with max. torque of 0.4 Nm.

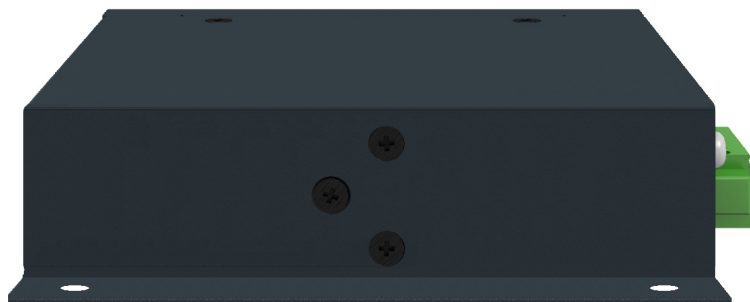

Figure 5: Screwed Wall Mounting Clip

1.9 DIN Rail Mounting



The DIN rail clip is not supplied with the router as standard accessories, but it can be ordered by the order code *BB-DIN-ICR32*.

The DIN rail clip is suitable for a DIN rail according to EN 60715 standard only. The default position of the clip is shown in Figure 6.



When mounting the DIN rail clip, tighten the screws with max. torque of 0.4 Nm.



Figure 6: Position of the DIN Rail Clip

To remove the router from the DIN rail it is necessary to lightly push down the router so that the bottom part of the DIN rail clip hitched to the DIN rail get out of this rail and then fold out the bottom part of the router away from the DIN rail, see Figure 7.

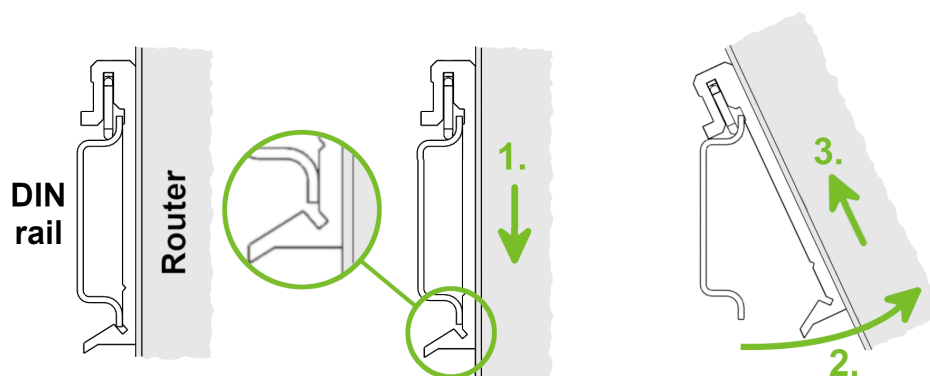

Figure 7: Removing Router from the DIN Rail

1.10 Product Label

The figure below shows an example of the product labels with all the information printed on them.

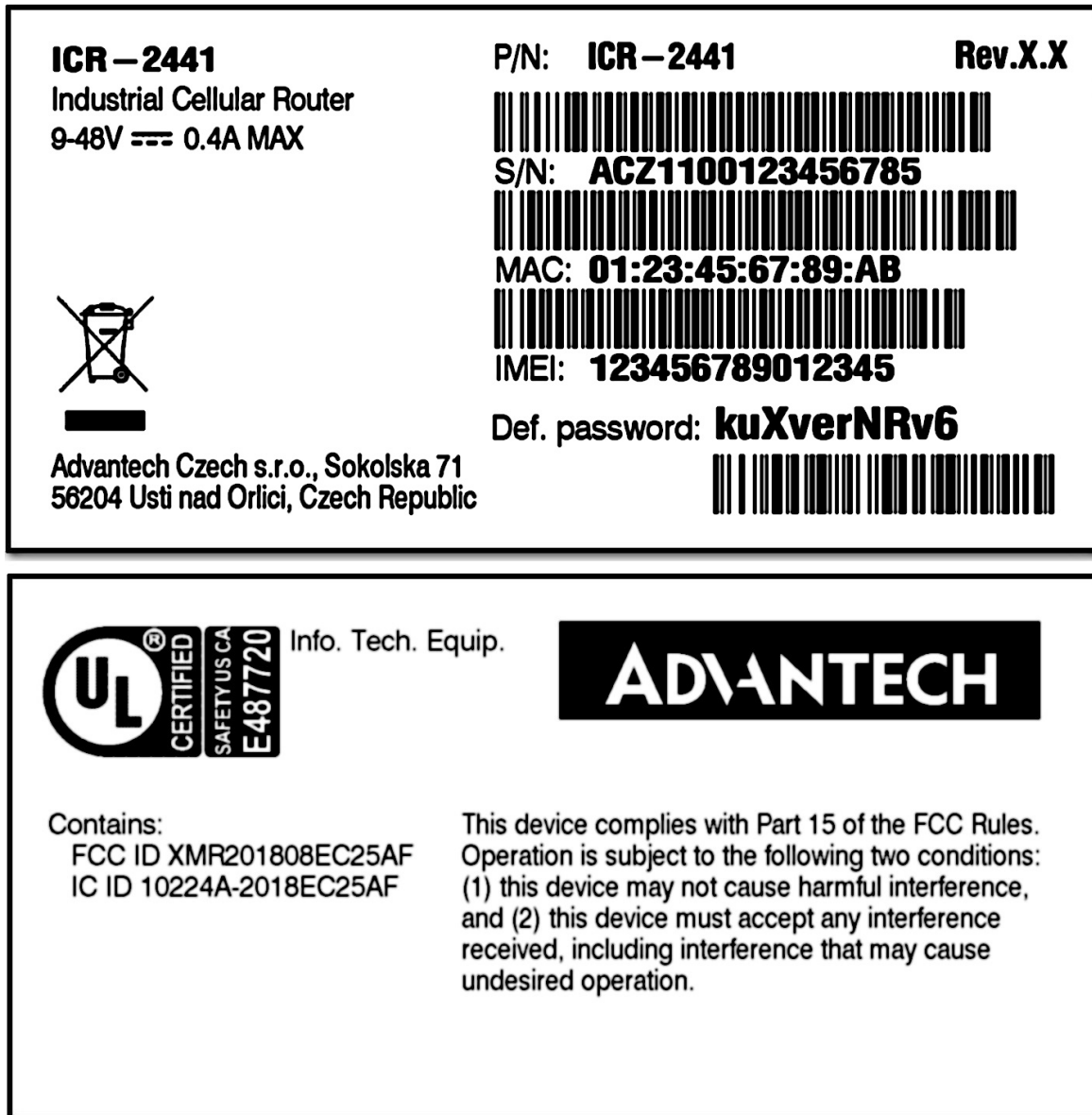



Figure 8: Product Label

1.11 First Use

You can perform the initial configuration of the router using a web browser on your PC. This interface enables router monitoring, configuration, and administration.

- 
- Before putting the router into operation, ensure that all components required for running your applications are connected. Refer to Chapter [1.2 Hardware Overview](#) for an overview of the hardware.
 - Do not operate the router without an antenna connected to the main antenna connector. Transmitted energy will be reflected by an open connector, which could potentially damage the equipment.

The procedure for connecting to a new router is described in the *Configuration Manual* [1], Chapter *Introduction* → *Configuration Environments* → *Initial Web Configuration GUI Access*. This manual also provides detailed descriptions and examples of router configuration using the web interface.

2. Hardware Functionality

See Chapter 1.2 for an overview of the product's hardware, along with links to chapters offering detailed explanations.

2.1 SIM Card Slots

Slots for two SIM cards are located on the router beneath a metal cover. If you plan to use this device for cellular network communication, insert an activated data-provisioned SIM card into the SIM card slot.

You have the option to install two SIM cards simultaneously for utilizing the switching feature. The SIM cards can have different Access Point Names (APNs) configured. The procedure for changing SIM cards is outlined below. If the SIM requires a PIN, input it in the router's web interface (*Administration* → *Unlock SIM Card*).

 Type of SIM card: Micro SIM (3FF) 15.0 × 12.0 × 0.76 mm.

Inserting the SIM card:

- Always disconnect the router from the power supply before handling the SIM card.
- Unscrew the two screws on the SIM card cover and remove the cover.
- To remove an inserted SIM card, use the flat end of a spudger or your fingernail to press the SIM card slightly into its slot until you hear a click. Upon hearing the click, release the card, and it will pop out of its slot.
- To insert a SIM card, push the card into the slot until it clicks into place.
- Put the cover back and secure it with the two screws.

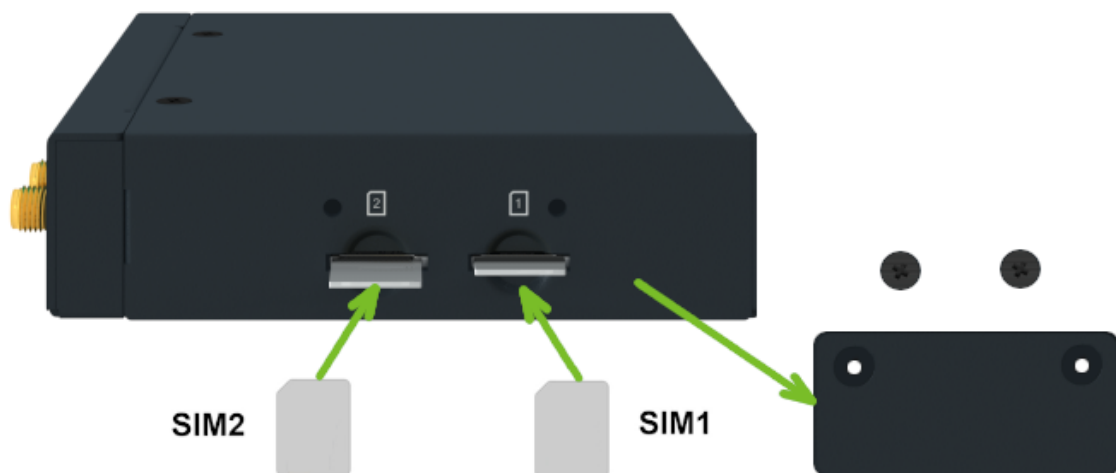

Figure 9: SIM Cards Insertion

2.2 Antennas

Connect cellular antennas to the router to main (ANT) and secondary (DIV) SMA female connectors on the front panel. Connect WiFi/GNSS antenna to the WiFi (AUX) RP-SMA female/SMA female connector on the side of the router.



If a short circuit occurs on the GNSS input, the cellular module will shut down. It will restart once the short circuit is resolved.



Only run the router with a cellular antenna connected to the main antenna connector, as the energy from the transmission is effectively reflected by the open end and can damage the equipment.



The DIV cellular antenna is required for the MIMO DL functionality.



The thread of the SMA connector for the WiFi antenna is connected to the internal ground, see Figure 14.



Recommended tightening moment for screwing the antenna to the SMA female connectors is 0.9 Nm.

2.3 Ethernet Interfaces



The maximum length of the cables connected to the Ethernet ports is 30 meters to meet the EMC immunity conditions.

The panel socket of RJ45 is used for Ethernet interface. The pinout of the socket is shown in Figure 10 and described in Table 6.

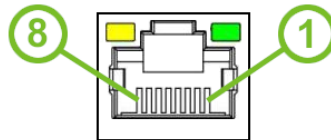

Figure 10: Ethernet Connector Pinout

| Pin | Signal mark | Description |
|-----|-------------|--------------------------------|
| 1 | Tx+ | Transmit Data+ (positive pole) |
| 2 | Tx- | Transmit Data- (negative pole) |
| 3 | Rx+ | Receive Data+ (positive pole) |
| 4 | — | — |
| 5 | — | — |
| 6 | Rx- | Receive Data- (negative pole) |
| 7 | — | — |
| 8 | — | — |

Table 6: Ethernet Connector Pinout Description



The isolation barrier of the Ethernet ports against the ground is 1500 V.

2.4 Power Supply

The power supply pins are physically connected to the 6-pin terminal block panel socket located on the left panel. The connection of the power supply is illustrated in Figure 11 and described in Table 7.

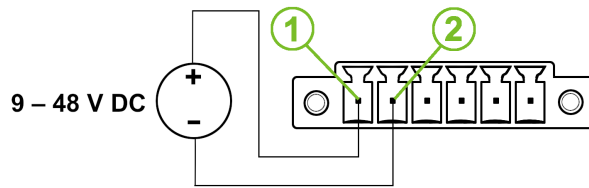

Figure 11: Connection of Power Supply

| Pin | Signal mark | Description |
|-----|-------------|---|
| 1 | PWR(+) | Positive pole of DC supply voltage (+9 to +48 V DC) |
| 2 | PWR(-) | Negative pole of DC supply voltage |

Table 7: Power Supply Pinout

The required power supply voltage for the router ranges between +9 V and +48 V DC. Refer to the connection scheme in Figure 11 for proper setup. The router is equipped with built-in protection against reversed polarity, functioning without signaling. To guarantee correct operation, the power source must be capable of providing a sufficient amount of energy, as detailed in the consumption section of Chapter 4.1.



Unit has to be supplied by a power supply specified as a Limited Power Source (LPS) or CEC/NEC Class 2 source of supply.



The power supply (common pole) is not connected to the metal case of the router nor to the internal ground, see Figure 14.

If recommended for the installation environment, it is advised to protect the router by properly grounding it using the grounding screw, as illustrated in Figure 12.



Figure 12: Position of the Grounding Screw

2.5 I/O Port Interfaces



The maximum length of wires connected to the I/O ports is 3 meters to meet the EMC immunity conditions.

The pins of I/O interface are physically connected to the 6-pin terminal block panel socket located on the left panel. The pinout of one digital input and one digital output is shown in Figure 13 and described in Table 8.

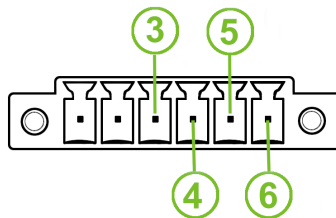

Figure 13: I/O Connector Pinout

| Pin | Signal mark | Description |
|-----|-------------|------------------------------------|
| 3 | IN(+) | The digital input (positive pole) |
| 4 | IN(-) | The digital input (negative pole) |
| 5 | OUT(+) | The digital output (positive pole) |
| 6 | OUT(-) | The digital output (negative pole) |

Table 8: I/O Ports Pinout

The I/O user interface is designed for digital input processing and digital output control. For detailed electrical parameters see Chapter 4.7. The functional scheme of connection for the digital input and digital output is in Figure 14.

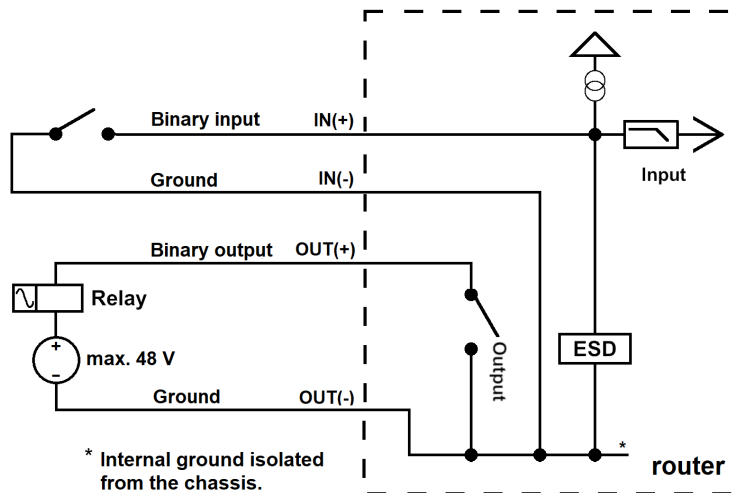

Figure 14: Functional Scheme of the Digital Interface

2.6 Serial Interfaces

The pins of RS232 and RS485 serial interfaces are physically connected to the 7-pin terminal block panel socket located on the left panel. The pinout of this connector is described in Figure 15 and in Table 9, resp. Table 10.

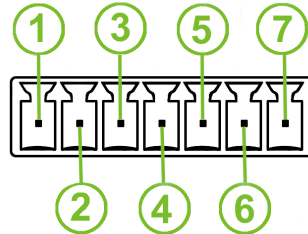

Figure 15: RS485 and RS232 Pinout

| Pin | Signal mark | Description |
|-----|-------------|----------------------------|
| 1 | D (+) | In/Out |
| 2 | D (-) | In/Out |
| 3 | GND | Ground (common with RS232) |

Table 9: Connection of RS485

| Pin | Signal mark | Description |
|-----|-------------|----------------------------|
| 3 | GND | Ground (common with RS485) |
| 4 | RXD | Received Data |
| 5 | TXD | Transmit Data |
| 6 | RTS | Request to Send |
| 7 | CTS | Clear to Send |

Table 10: Connection of RS232



The serial interfaces are not electrically isolated from the router. The ground is connected to the internal ground, see Figure 14.

2.7 LED Status Indication

There are LED indicators on the front panel of the router to provide router status information. Moreover, ETH connector, has two additional LEDs providing information about the port status.

| Caption | Color | State | Description |
|--------------|--------|---------------|--|
| PWR | Green | On | The router is booting up. |
| | Green | Blinking | The router booted up and is ready. |
| | Green | Fast blinking | The router firmware is being updated. |
| USR | Green | — | The function of this LED is user-defined. |
| DI | Green | On | The digital input is active. |
| DO | Green | On | The digital output is active. |
| DAT | Green | Blinking | Cellular communication is in progress. |
| SIG | Green | On | Good cellular signal. |
| | | Blinking | Fair cellular signal. |
| | | Fast blinking | Poor cellular signal. |
| TECH | Green | On | The active SIM uses 4G technology. |
| | | Blinking | The active SIM uses 3G technology. |
| | | Fast blinking | The active SIM uses 2G technology. |
| SIM | Green | On | SIM1 is active for the cellular connection. |
| | | Blinking | SIM2 is active for the cellular connection. |
| | | Fast blinking | A SIM issue (missing card or PIN not entered). |
| ETH0 | Green | On | Selected 100 Mbps bit rate. |
| ETH1 | Green | Off | Selected 10 Mbps bit rate. |
| ETH0 ETH1 | Orange | On | The network cable is connected. |
| | | Blinking | Data transmission. |
| | | Off | The network cable is not connected. |

Table 11: LED Status Indication

2.8 Reset Functions

The *RST* button has multiple functions. For more details, refer to the configuration manual [1], Chapter *Introduction* → *Device* → *Reset*.

 Use a narrow screwdriver or a small tool to press the *RST* button.

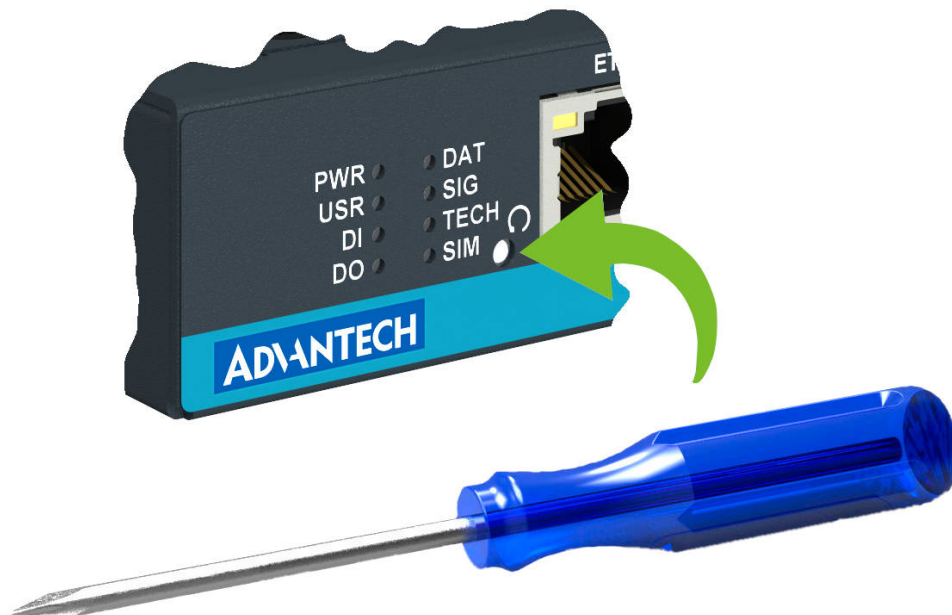

Figure 16: Resetting the Router

3. Technical Specifications

3.1 Basic Parameters

| Parameter | | Description |
|--|----------------------------|--|
| Temperature range | Operating Storage | -40 °C to +75 °C (-40 °F to +167 °F) -40 °C to +85 °C (-40 °F to +185 °F) |
| Humidity | Operating Storage | 5 to 95 % relative humidity non condensing 5 to 95 % relative humidity non condensing |
| Altitude | Operating | 2000 m / 70 kPa |
| Degree of protection | | IP30 |
| Supply voltage | | 9 to 48 V DC |
| Battery for RTC | | CR2032 / CR1225 ¹ |
| Consumption for non-WiFi GNSS WiFi version | Idle Average Maximum | 1.7 W 2.0 W 3.0 W 3.8 W 3.6 W 4.3 W |
| Dimensions of device w/o clip | | 103 × 95 × 25 mm (4.06" × 3.74" × 0.98") |
| DIN rail clip (optional part) specification | | DIN 35 mm, EN 60715 |
| Weight for non-WiFi WiFi | Box w/o clip | 345 g (0.76 lbs) 355 g (0.78 lbs) |

Table 12: Basic Parameters

¹For product revision 2.0 and higher.

3.2 Standards and Regulations

The router complies with the following standards and regulations:

| Parameter | Description |
|-------------------|---|
| Radio | FCC part 22H, FCC part 24E, FCC part 27C, FCC part 90H, PTCRB |
| EMC | EN 61000-6-2, FCC part 15.B, ICES-003 Issue 6 |
| Safety | EN IEC / UL 62368-1 |
| Carrier Approvals | Verizon, AT&T, T-Mobile |
| National | FCC, IC compliant |
| Environmental | REACH, RoHS3 and WEEE compliant |

Table 13: Standards and Regulations

3.3 Type Tests and Environmental Conditions

| Phenomena | Test | Description | Test levels |
|--------------------------|---------------|---|--|
| ESD | EN 61000-4-2 | Enclosure | CD \pm 6 kV, L3 |
| RF field AM modulated | EN 61000-4-3 | Enclosure | 20 V/m, 80 MHz-1 GHz, LX 10 V/m, 1 GHz-6 GHz, L3 |
| Fast transient | EN 61000-4-4 | DC port ETH - FTP Digital input Digital output RS232 RS485 | \pm 1 kV, 5/50 Tr/Th ns, 100 kHz, L2 \pm 1 kV, 5/50 Tr/Th ns, 100 kHz, L3 \pm 1 kV, 5/50 Tr/Th ns, 100 kHz, L3 \pm 1 kV, 5/50 Tr/Th ns, 100 kHz, L3 \pm 1 kV, 5/50 Tr/Th ns, 100 kHz, L3 \pm 1 kV, 5/50 Tr/Th ns, 100 kHz, L3 |
| Surge | EN 61000-4-5 | ETH RS485 | \pm 1 kV, 1.2/50(8/20) Tr/Th us, L2 \pm 1 kV, 1.2/50(8/20) Tr/Th us, L2 |
| RF conducted | EN 61000-4-6 | DC port ETH I/O ports RS232 RS485 | 10 V, 0.15-80 MHz, 80%AM(1kHz), L3 10 V, 0.15-80 MHz, 80%AM(1kHz), L3 10 V, 0.15-80 MHz, 80%AM(1kHz), L3 10 V, 0.15-80 MHz, 80%AM(1kHz), L3 10 V, 0.15-80 MHz, 80%AM(1kHz), L3 |
| Radiated emission | EN 55032 | Enclosure | Class B, 30 MHz-1 GHz, 1 GHz-6 GHz |
| Conducted emission | EN 55032 | DC power port Ethernet ports Serial ports RS232 RS485 | Class B, 150 kHz-30 MHz Class B, 150 kHz-30 MHz Class B, 150 kHz-30 MHz Class B, 150 kHz-30 MHz Class B, 150 kHz-30 MHz |
| Dry heat | EN 60068-2-2 | Operating Storage | Test Bb, storage +75 °C Test Bd, operation +85 °C |
| Cold | EN 60068-2-1 | Operating Storage | Test Ab, storage -40 °C Test Ad, operation -40 °C |
| Variation of temperature | EN 60068-2-14 | Test Nb, -40 °C / +75 °C, 3h/3h, 2 cycles, 3 K/min | |
| Dry heat, cyclic | EN 60068-2-30 | +55 °C / +25 °C, rel. humidity 95 %, 6 h-6 h | |

Table 14: Type Tests and Environmental Conditions

3.4 Parameters of Cellular Module

| Parameter | Description |
|------------------|---|
| Antenna | Connector type: SMA Impedance: 50 Ω |
| LTE parameters | LTE: Cat.4, 3GPP E-UTRA Release 11 LTE technology FDD frequencies: B71 (600 MHz), B12, B13, B14 (700 MHz), B5 (850 MHz), B4, B66 (1700 MHz), B2 (1900 MHz) LTE FDD bit rates: 150 Mbps (DL) / 50 Mbps (UL) Supported bandwidths: 1.4 MHz, 3 MHz, 5 MHz, 10 MHz, 15 MHz, 20 MHz |
| WCDMA parameters | Supported frequencies: B5 (850 MHz), B4 (1700 MHz), B2 (1900 MHz) Bit rates: 4.2 Mbps (DL) / 2.2 Mbps (UL) |

Table 15: Technical Parameters of Cellular Module

3.5 Parameters of GNSS

| Parameter | Description |
|-------------------------------|---|
| Antenna | 50 Ω – active |
| Protocols | NMEA 0183 |
| GNSS Systems | GPS, GLONASS, BeiDou, Galileo, QZSS |
| Frequency | GPS/Galileo/QZSS: 1575.42 \pm 1.023 MHz GLONASS: 1597.5 – 1605.8 MHz BeiDou: 1561.1 \pm 2.046 MHz |
| Sensitivity (autonomous) | Tracking: -157 dBm Reacquisition: -157 dBm Cold start: -146 dBm |
| Acquisition time (autonomous) | Hot start: 2.5 s Warm start: 26 s Cold start: 35 s |
| Accuracy | < 1.5 m |

Table 16: Technical parameters of GNSS

3.6 Parameters of WiFi

| Parameter | Description |
|-----------------------|---|
| Supported Standards | IEEE802.11 ac/a/b/g/n 2.4 GHz / 5 GHz |
| Antenna Connector | 1x RP-SMA Input impedance: 50 Ω |
| Data Rate | 802.11b: 1, 2, 5.5, 11Mbps 802.11a/g: 6, 9, 12, 18, 24, 36, 48, 54 Mbps 802.11n: Max. 72 Mbps @ 20 MHz channel 802.11n: Max. 150 Mbps @ 40 MHz channel |
| Frequency Ranges | 2.4 GHz ISM Bands 2.412-2.472 GHz 5.15-5.25 GHz (FCC UNII-low band) for US/Canada and EU 5.25-5.35 GHz (FCC UNII-middle band) for US/Canada and EU 5.47-5.725 GHz for EU 5.725-5.825 GHz (FCC UNII-high band) for US/Canada |
| Modulation | DSSS, OFDM, DBPSK, DQPSK, CCK, 16-QAM, 64-QAM |
| 2.4 GHz Channels | 1, 2, 3, 4, 5, 6, 7, 8, 9, 10, 11, 12, 13 |
| 5 GHz Channels | 36, 38, 40, 42, 44, 46, 48, 52, 56, 60, 64, 100, 104, 108, 112, 116, 120, 124, 128, 132, 136, 140, 149, 153, 157, 161, 165 |
| Type of Device | Access point (AP) (up to 8 clients) Station (STA) Multirole (STA&AP) |
| Security – Standards | WPA, WPA2, WPA3, 802.1X |
| Security – Encryption | WEP, TKIP, AES |
| TX Power | Max. 18 dBm @ 2.4 GHz Max. 15 dBm @ 5 GHz |

Table 17: Technical Parameters of WiFi

3.7 Parameters of I/O Ports

Electrical characteristics of the digital input are in Table 18. Status of the digital input is reported in the GUI on *General Status* page or can be retrieved in the Shell via `io get bin0` command.

| get command output | Voltage | Web interface status |
|--------------------|-------------------------------|----------------------|
| 0 | $\leq 0.8\text{ V}$ (0.5 mA)) | On |
| 1 | $\geq 2\text{ V}$ | Off |

Table 18: Electrical Characteristics of Digital Input

The maximum digital output load is **100 mA** at **9 – 48 V**.

3.8 Parameters of Serial Interfaces

Supported parameters of the RS232 and RS485 interfaces, which can be configured in *Expansion Port 1* resp. *Expansion Port 2* menu items, are in Table 19.

| Parameter | Description |
|--------------|--|
| Baudrate | 300, 600, 1200, 2400, 4800, 9600, 19200, 38400, 57600, 115200, 230400. |
| Data Bits | 5, 6, 7, 8. |
| Parity | none, even, odd. |
| Stop Bits | 1, 2. |
| Flow Control | none, hardware. |

Table 19: Parameters of Serial Interfaces

3.9 System Configuration

The main parameters of the system are listed in Table 20.

| Parameter | Description |
|------------------|--|
| CPU architecture | ARM926EJ-S |
| CPU frequency | 600 MHz |
| CPU power | 4,72 DMIPS/MHz |
| Flash memory | 64 MB NOR Flash <ul style="list-style-type: none">• 12 MB for Router Apps• 2 MB for customer data |
| RAM size | 128 MB |
| Watchdog | HW Watchdog |
| RTC | Battery Backup RTC |

Table 20: System Configuration

Appendix A: Troubleshooting

If you cannot connect to the router from your PC, your network card may be configured in such a way that it is not possible to connect to the router. Take one or more of the following steps in order to solve the problem:

- Make sure your PC's network card is configured to obtain the IP address from the DHCP server (by default the DHCP server is running in the router).
- Connect the router to the PC via Switch.
- Connect the router to the PC, start the router first and then start the PC after the router's initialization.

Ethernet connection fails or is not establishing.

- It is possible to turn auto negotiation off and set a rate and duplex manually on the Ethernet interface of the router. Available on "LAN Configuration" page in the router.

Mobile WAN connection fails.

- Check the signal power ("Mobile WAN status" page). If the signal power is weak, you will have to use a better antenna. If the neighbouring cells have a similar signal strength, you will need to use a directional antenna. For proper operation, the signal levels have to be good.
- Try to enable automatic ping from the router, which will check the connection when there are no data running and in the case of a failed ping, restart the connection. This can be done on the "Mobile WAN Configuration" page in the router in the "Check connection" section. "Enable + bind" option is to ensure the ping goes always through Mobile WAN network interface.

Mobile WAN connection cannot be established.

- Check the "Mobile WAN Configuration" – APN, name, password and IP address (all can be blank).
- Try to enter the SIM card PIN – verify that the SIM card has the PIN code entered. Available on "Unlock SIM Card" page in the "Administration" section.
- In a private APN it is not recommended to get the DNS settings from operator (on "Mobile WAN" page)
- Go to "System Log" page in "Status" section and observe where the error occurs.

I cannot connect from the Internet to the device behind the router. I have NAT enabled.

- The device's gateway has to be configured so it points to the router.

I can't access my Web server placed behind the router over NAT.

- The remote HTTP access to the router has to be disabled on "NAT Configuration" page in the router. Also enable "Send all remaining incoming packets to default server" feature and fill in the IP address of your Web server. On the Web server, the default gateway has to be the IP address of the router.

DynDNS doesn't work.

- With private APN this will not work.

- If the same IP address is recorded in your canonic name as a dynamically assigned address, it means that the operator is using NAT or a firewall.
- You can verify NAT using ping to your server with static address and then compare with router's IP address.
- You can verify a Firewall by accessing remotely to the router's Web interface.
- The operator may not provide the address of DNS server and without DNS server's address it is impossible to connect to the dyndns.org server. The following messages will be shown in the System Log:
 - DynDNS daemon started
 - Error resolving hostname: no such file or directory
 - Connect to DynDNS server failed

 **L2TP or IPSec isn't establishing.**

- Check the "System Log" page for error messages.

 **IPSec tunnel establishes but the communication does not run.**

- Probably there are bad routing rules defined in the connected devices, or the default gateway.

 **I switched the router to offline mode by SMS message, but the router is in online mode after reboot.**

- SMS messages do not change the router configuration. They remain in effect only until the router is rebooted.

Serial communication is not working.

- Verify that the router model supports serial communications. Also verify the serial communication settings. To do so, open the router's configuration menu via the web browser, select the appropriate "Expansion Port" from "Configuration" part of the menu and verify the settings.

Is the router Cisco compatible? Can I use the Cisco configuration?

- No, the Firmware in the router (ICR-OS) is based on Linux with BusyBox. Thus the Cisco configuration cannot be used. But network connections are defined by standards so connecting the router to the Cisco or other networking devices is possible and will be compatible.

FTP or SFTP does not work

- FTP will work on v2 routers only. You can use SFTP on all routers to transfer files to/from the router. If having troubles with FTP on v2 routers, make sure you have FTP enabled: "Configuration" section, "Services", "FTP". Then you can connect with any client on port 21 with name and password same as for the Web interface. If having troubles with SFTP, make sure you have SSH enabled: "Configuration" section, "Services", "SSH". Then you can connect with any client on port 22 with name and password same as for the Web interface.

How can I connect to the router's command line? (SSH, Telnet)

- You can use SSH on all routers or Telnet on v2 routers only. SSH is enabled by default, but you can verify in Web interface in "Configuration" section, "Services", "SSH". Then connect with any SSH client on port 22 of the router. User and password is the same as for the Web interface. Telnet on v2 routers can be enabled here: "Configuration" section, "Services", "Telnet".

Appendix B: Customer Support

Customer Support for Europe

Advantech Czech s.r.o.

Sokolska 71
562 04, Usti nad Orlici
Czech Republic

Phone: +353 91 792444
Fax: +353 91 792445
E-mail: iiotcustomerservice@advantech.eu
Web: www.advantech.com

Customer Support for NAM

Advantech B+B SmartWorx

707 Dayton Road
Ottawa, IL 61350 USA

Phone: +1-800-346-3119 (Monday – Friday, 7 a.m. to 5:30 p.m. CST)
Fax: +1-815-433-5109
E-mail: support.iiot.ana@advantech.com
Web: www.advantech.com

Customer Support for Asia

Phone: +886-2-2792-7818 #1299 (Monday – Friday, 9 a.m. to 5:30 p.m. UTC+8)
Fax: +886-2-2794-7327
E-mail: icg.support@advantech.com.tw
Web: www.advantech.com

Appendix C: Regulatory & Safety Information

Safety Notices



Please, observe the following instructions:

- The router must adhere to all relevant international and national laws, including any specific restrictions governing its use in designated applications and environments.
- To prevent potential injury and appliance damage, ensure compliance with regulations by using only authorized accessories. Unauthorized modifications or use of unapproved accessories could damage the router, violate regulations, and void the warranty.
- Do not attempt to open the router.
- Before handling the SIM card, turn off the router and disconnect it from the power supply.
- **Caution!** This equipment is not suitable for use in areas with children. Small children could swallow the SIM card.
- Ensure the power supply does not exceed 48 V DC maximum.
- Avoid exposing the router to extreme ambient conditions. Safeguard it against dust, moisture, and high temperatures.
- Only deploy routers with appropriate certification and labeling in environments containing flammable or explosive materials, such as gas stations, chemical plants, or areas involving explosives. Users must observe restrictions pertaining to radio device usage in such settings.
- When traveling by plane, switch off the router. Using it onboard could jeopardize flight operations, disrupt mobile networks, and potentially violate regulations. Non-compliance may result in telephone service suspension, cancellation, or legal repercussions.
- Exercise heightened caution when operating the router near personal medical devices like cardiac pacemakers or hearing aids.
- The router may cause interference when operated in close proximity to TV sets, radio receivers, or personal computers.
- It's advisable to create a suitable backup of all critical settings stored in the device's memory.



Product Disposal Instructions

The WEEE (Waste Electrical and Electronic Equipment: 2012/19/EU) directive was introduced to ensure that electrical/electronic products are recycled using the best available recovery techniques to minimize the environmental impact. This product contains high quality materials and components which can be recycled. At the end of its life this product **MUST NOT** be mixed with other commercial waste for disposal. The device contains a battery. Remove the battery from the device before disposal. The battery in the device needs to be disposed of apart accordingly. Check the terms and conditions of your supplier for disposal information.

Appendix D: Related Documents

[1] *ICR-2[0456]00 Configuration Manual* (see *Documents to download* → *Manuals* section)



[EP] Product-related documents and applications can be obtained on **Engineering Portal** at <https://icr.advantech.com/download> address.