

ICR-2441

Entry-Level 4G Router



Features

- LTE Cat.4 with 3G fallback
- 2x SIM for redundancy
- 2x Ethernet 10/100 Mbps
- 1x RS232, 1x RS485
- 1x DI, 1x DO
- Wide operational temperature range
- Wall and DIN mount options
- Linux based OS & SW customization
- Carriers support: Verizon, AT&T, T-Mobile
- Optional WiFi 802.11n
- Optional GNSS receiver



Introduction



Industrial cellular router ICR-2441 is designed for wireless communication to enable the connection of IP or serial devices to a cellular network. Industrial M2M and IoT applications include kiosks, industrial PCs, HMIs, traffic controllers, meters, UPS systems, and much more. The peak downlink data rate for LTE Cat.4 is approximately 150 Mbps. Also in the uplink, LTE Cat.4 provides a peak data rate of 50 Mbps. Optional built-in WiFi 802.11 ac,b,g,n with AP, Client and Multirole modes are available.

The router is equipped with two independently configurable Ethernet ports (LAN or WAN), 1x serial port RS232, 1x RS485, and digital I/O connectivity (1 x DI, 1 x DO). Optional built-in WiFi 802.11 ac,b,g,n with AP, Client, and Multirole modes are available. The router supports VPN tunnel creation using various protocols to ensure safe communications. The router provides diagnostic functions which include automatic monitoring of the wireless and wired connections, automatic restart in case of connection losses, and a hardware watchdog that monitors the router status.

The router is based on the ICR-OS operation system. Open Linux platform enables wide possibilities of programming customer SW applications in Python and C/C++. The router supports uploading of Router Apps that would extend standard firmware functionalities. The existing app library ready for free download by customers contains already developed software apps to enhance specific router functionality including industrial protocol conversions, support of IoT platforms such as MS Azure, Cumulocity, ThingWorx, and a lot more.



Order Codes

Model no. - Order Codes	REGION	2x Ethernet	RS232 RS485	I/O	1x ANT 1x DIV	2x SIM	WiFi 802.11ac	GNSS <small>PLANNED</small>
 ICR-2441	NAM	✓	✓	✓	✓	✓		
 ICR-2441W	NAM	✓	✓	✓	✓	✓	✓	
 <small>PLANNED</small> ICR-2441G	NAM	✓	✓	✓	✓	✓		✓

Specifications

System	
CPU	ARM926EJ-S, 600 MHz
Memory	RAM - 128 MB NOR Flash - 64 MB (12 MB for Router Apps, 2 MB for customer data)
Watchdog	HW Watchdog
RTC	Battery backup RTC
Interfaces	
Ethernet	2× Ethernet (1+1), RJ45, 10/100 Mbps
Serial Lines	1× RS232 (Tx, Rx, GND, RTS, CTS) 1× RS485 (A(-), B(+), GND) (7-pin terminal block)
I / O	1× Digital Input (48 V / 0.5 mA) 1× Digital Output (Open Drain, 48 V / 100 mA) (6-pin terminal block together with PWR)
Reset Button	Reboot / Factory reset
LED Indicators	System, Signal strength, Data activity, SIM1/SIM2 status, Mobile technology, Input, Output, User, ETH

Environmental	
Power Supply	9 – 48 V DC (6-pin terminal block together with I/O)
Consumption	ICR-2441: Idle 1.7 W / Average 3 W / Maximum 3.6 W ICR-2441W: Idle 2.3 W / Average 4.4 W / Maximum 6.7 W
Operating Temperature	-40 to +75 °C
Storage Temperature	-40 to +85 °C
Humidity	5 to 95 %
IP Cover	IP30
Physical Characteristics	
Dimensions	103 mm × 95 mm × 25 mm
Enclosure	Metal Case, Grounding Screw
Mounting	Wall mount, * Optional DIN Rail mount
Weight	345 g (0,76 lbs)

WiFi - optional (ICR-2441W)	
Antenna	1× R-SMA connector
Standards	IEEE802.11 ac/a/b/g/n 2.4 GHz / 5 GHz
Security	WEP, WPA, WPA2, WPA3, 802.1X
Modes	Access Point (up to 8 clients), Station, Multirole STA & AP

GNSS - optional (ICR-2441G) PLANNED	
Antenna	1× SMA connector, active (50 mA)
Systems	GPS, GLONASS, BeiDou, Galileo, QZSS
Protocol	NMEA 0183
Ac Time-to-First-Fix	Hot start: 2.5 s Warm start: 26 s Cold start: 35 s

Cellular Interface	
SIM Slots	2× SIM (Micro SIM – 3FF)
Antennas	2× SMA connector (1× ANT, 1× DIV)
LTE Parameters	Supported FDD frequencies: B2 (1900 MHz), B4 (1700 MHz), B5 (850 MHz), B12 (700 MHz), B13 (700 MHz), B14 (700 MHz), B66 (1700 MHz), B71 (600 MHz) Transfer rate: 150 Mbps (DL), 50 Mbps (UL)
HSPA+/UMTS Parameters	Supported frequencies: , B2 (1900 MHz), B4 (1700 MHz), B5 (850 MHz) Transfer rate: 4.2 Mbps (DL), 2.2 Mbps (UL)

Standards & Regulations	
Certifications ongoing (Subject to change)	
Radio	FCC part 22H, FCC part 24E, FCC part 27, PTCRB
EMC	EN 61000-6-2, FCC part 15.B, ICES-003 Issue 6
Safety	IEC 62368-1
National	FCC, IC
Carrier Approval	Verizon, AT&T, T-Mobile
Mechanical	EN 60068-2-27, EN 60068-2-64, EN 60068-2-64, MIL-STD-810G, SAE J1455
Climatic	EN 60068-2-2, EN 60068-2-1, EN 60068-2-14, EN 60068-2-78, MIL-STD-810G, SAE J1455
Environmental	REACH, RoHS3, WEEE
Cellular Module Approvals*	Regulatory: GCF, FCC, IC, PTCRB Carrier: Verizon, AT&T (FirstNet), T-Mobile, U.S. Cellular, Rogers, Telus

*Approvals are valid for the integrated cellular module inside the router only. Cellular module approvals are not always applicable for the whole router – see “Standards and Regulations” chart for complete router approvals available.

Software	
Operating System	ICR-OS (Linux based)
SW Customization	Router App
Application Development	Open Linux, *Python, BASH, C/C++
Industrial Protocols and IoT	*Modbus RTU/TCP gateway, *IEC 60870-5-101 to 104 gateway, *DF1, *DNP3, *MQTT, *LWM2M
Networking Features and Protocols	DHCP, NAT/PAT, SSH, VRRP, PPPoE, SNMP, SMTP, Dynamic DNS client, DNS proxy, VLAN, QoS, *DMVPN, NTP Client/Server, *Routing protocols RIP, BGP, OSPF, IS-IS, NHRP, Backup Routes, Port Forwarding, Host Port Routing, Ethernet Bridging, Load Balancing, IPv6 Dual Stack
Security	HTTPS, SSH, SFTP, DMZ, Firewall (IP Filtering, MAC address filtering, Inbound and outbound Port filtering) VPN Tunneling – WireGuard, OpenVPN, *EasyVPN, IPsec with IKEv1 and IKEv2, GRE, L2TP, PPTP Authentication – RADIUS, TACACS+, 2FA, *SCEP Encryption – DES, 3DES, AES, RSA, MD5, SHA
Firmware Management	Automatic firmware updates – server, locally via LAN or remotely via WAN
Diagnostic/Log	Status – Signal Strength, Data Usage One CLICK report – Current Configuration, Factory Identification, Routing Table Log – System Log, Reboot Log, Kernel Log Remote Diagnostics (via SSH)
Event Engine	StartUp script & Up/Down script (Own rules based on Digital Inputs, Network Parameters, Data Usage, Timer) Report Types: SMS, email, SNMP Trap
Configuration	Web server, SSH, Four configuration switchable profiles, Automatic configuration update from server, Backup & Restore configuration
Advanced Software Tools	WebAccess/DMP – Remote Device Provisioning, Monitoring & Management Platform WebAccess/VPN – Advanced Secure Networking Platform

*Functionality is available with installed Router App

Accessories

Part Number	Description	Included in the package
CON-ICR2-6-PWR	6-pin PWR / IO connector	✓
CON-ICR2-7-SER	7-pin Serial connector	✓
	Wall mount kit	✓
BB-DIN-ICR32	DIN Clip	
BB-KD-ETH	Ethernet cross cable, length 1.5m	
ANT-LTE5G-025	Antenna 5G/LTE, Terminal, SMA-M	
OPT1-ANT-WFT-06	Antenna Wi-Fi, Terminal	
OPT1-ANT-GNS-20	Antenna GNSS, Magnetic mount	
RPS-ICR2-US	Power Supply, ICR2, 12V/1A, 6-pin, US plug	

*For more Antenna accessories visit www.advantech.com

Views

FRONT VIEW

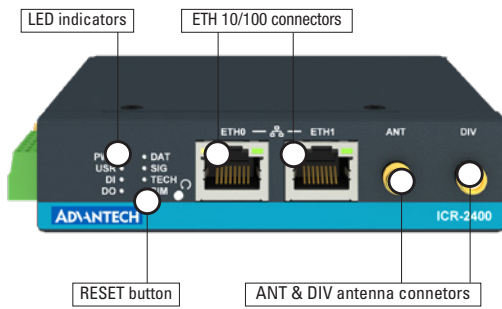

LEFT SIDE VIEW

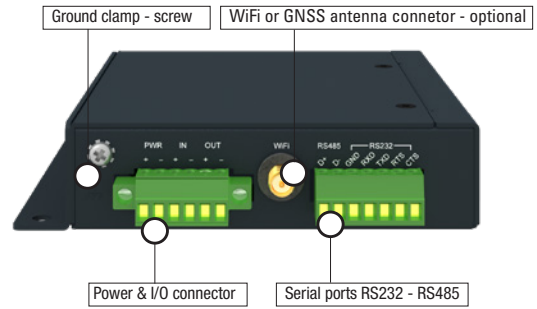

RIGHT SIDE VIEW

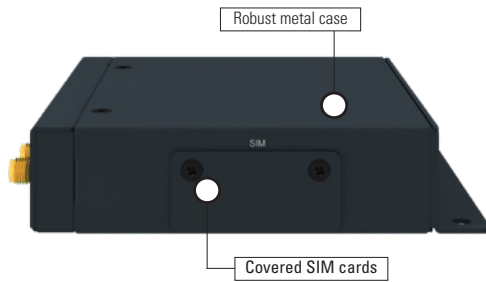

REAR VIEW

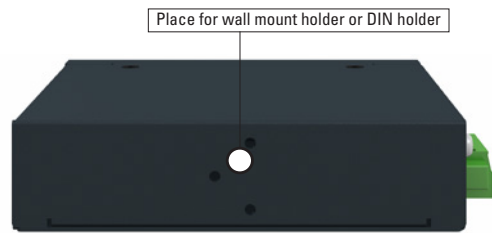

Dimensions - Technical Drawing

Version with L holder (Wall mount)

Unit: mm

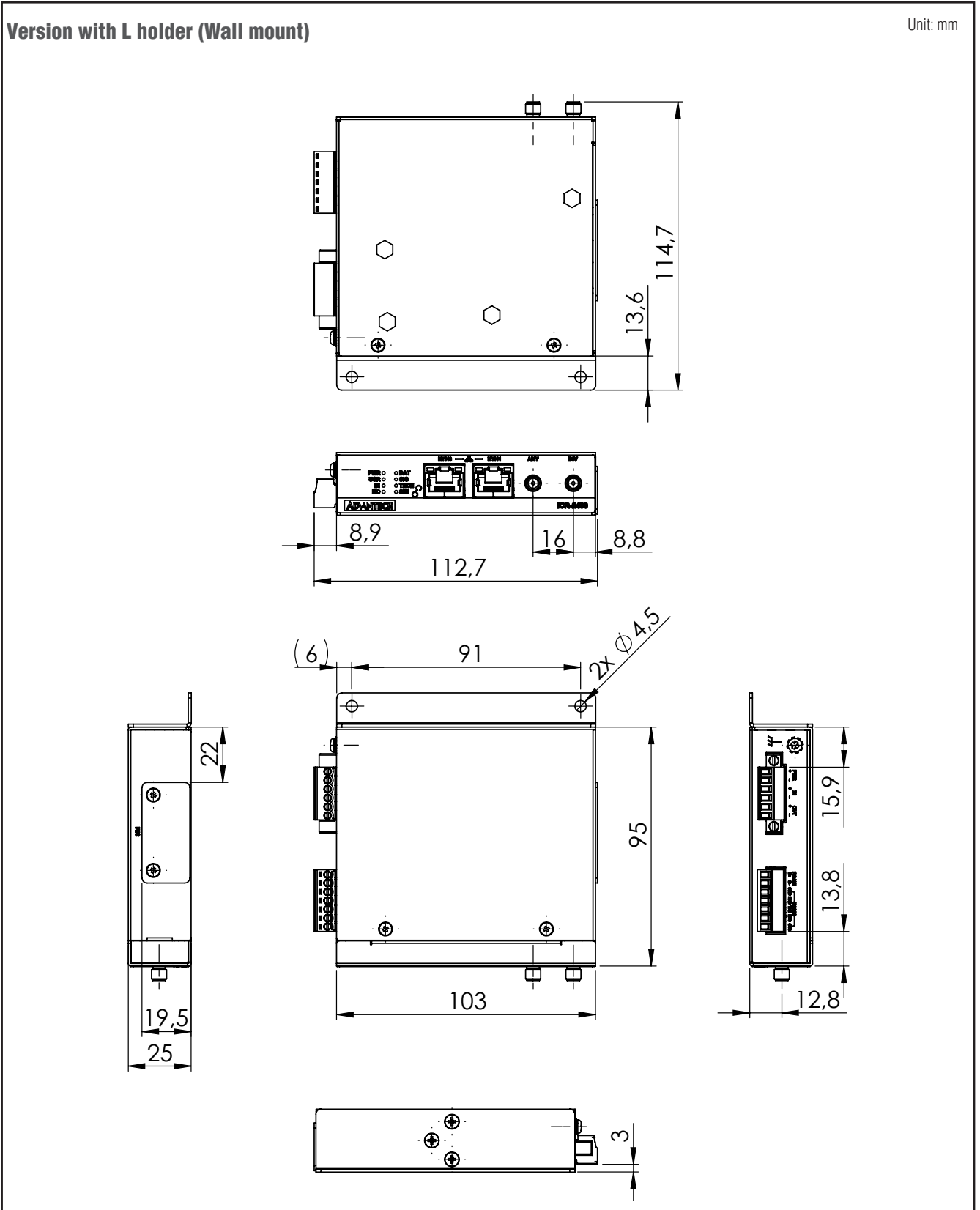

Dimensions - Technical Drawing

Version with DIN holder (*Optional Accessories)

Unit: mm

